



SOD-323 Plastic-Encapsulate ESD Protection Diodes

DESCRIPTION

The LESD3Z5.0C is designed to protect voltage sensitive components from ESD and transient voltage events. Excellent clamping capability, low leakage, and fast response time, make these parts ideal for ESD protection on designs where board space is at a premium.

This device has been specifically designed to protect sensitive components which are connected to data and transmission lines from overvoltage caused by ESD (electrostatic discharge), CDE (Cable Discharge Events), and EFT (electrical fast transients).

Features

- ◆ Peak power dissipation: 60W (8/20 μ s)
- ◆ IEC61000-4-2 (ESD) \pm 15kV (air), \pm 8kV (contact)
- ◆ IEC61000-4-4 (EFT) 40A (5/50ns)
- ◆ Protects one I/O line)
- ◆ Low clamping voltage
- ◆ Working voltages : 5V
- ◆ Low leakage current
- ◆ Meets MSL 1 Requirements

Pin Configuration



Circuit Diagram

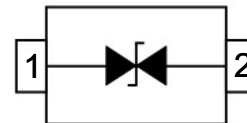

Applications

- ◆ High Speed Line :USB1.0/2.0, VGA, DVI, SDI,
- ◆ Serial and Parallel Ports
- ◆ Notebooks, Desktops, Servers
- ◆ Projection TV
- ◆ Cellular handsets and accessories
- ◆ Portable instrumentation
- ◆ Peripherals

Mechanical Characteristics

- ◆ Package: SOD-323
- ◆ Flammability Rating: UL 94V-0
- ◆ Terminal: Tin plated, solderable per MIL-STD-750, method 2026
- ◆ High temperature soldering guaranteed: 260 $^{\circ}$ C/ 10s
- ◆ Packaging: Tape and Reel
- ◆ Marking: 3M or AC

Absolute Maximum Ratings (T_A=25 $^{\circ}$ C unless otherwise specified)

Parameter	Symbol	Value	Unit
ESD per IEC 61000-4-2 (Air)	VESD	\pm 30	KV
ESD per IEC 61000-4-2 (Contact)		\pm 30	
Peak Pulse Power(8/20us)	PPP	60	W
Operating Temperature	T _{OPT}	-55 to +150	$^{\circ}$ C
Storage Temperature	T _{STG}	-55 to +150	$^{\circ}$ C
Lead Solder Temperature – Maximum (10 Second Duration)	T _L	260(10 sec.)	$^{\circ}$ C

The above data are for reference only.

**Electrical Characteristics** ($T_A=25^{\circ}\text{C}$ unless otherwise specified)

Symbol	Parameter	Test Condition	Min	Typ	Max	Units
V_{RWM}	Reverse Working Voltage				5.0	V
V_{BR}	Reverse Breakdown Voltage	$I_T = 1\text{mA}$	5.6		7.8	V
I_R	Reverse Leakage Current	$V_{RWM} = 5.0\text{V}$			1.0	μA
V_C	Clamping Voltage	$I_{PP} = 5\text{A}$, $t_p = 8/20\mu\text{s}$			12	V
C_J	Junction Capacitance	$V_R = 0\text{V}$, $f = 1\text{MHz}$			18	pF

The above data are for reference only.

ELECTRICAL CHARACTERISTICS CURVE

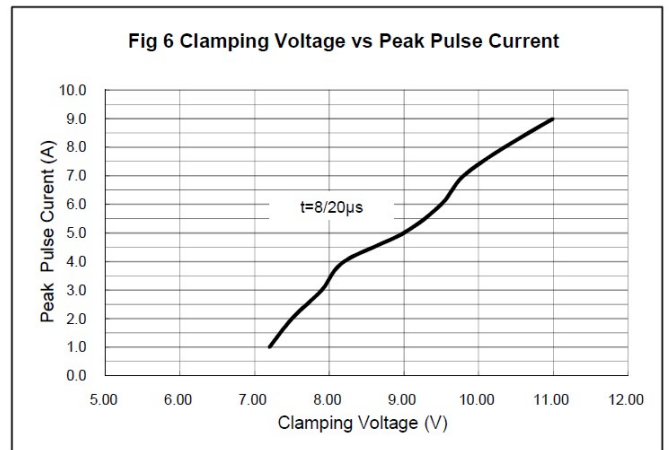
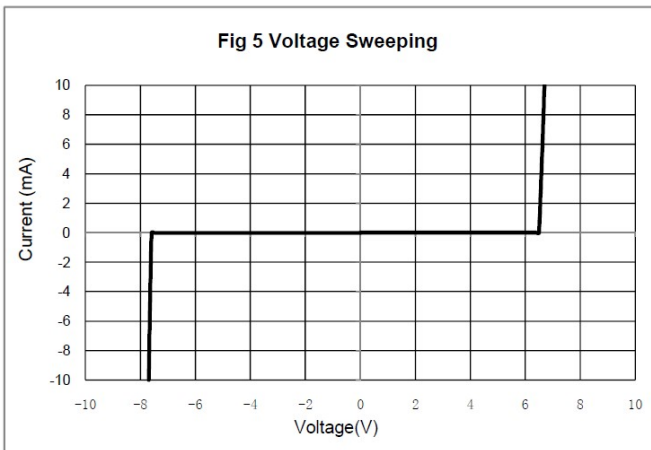
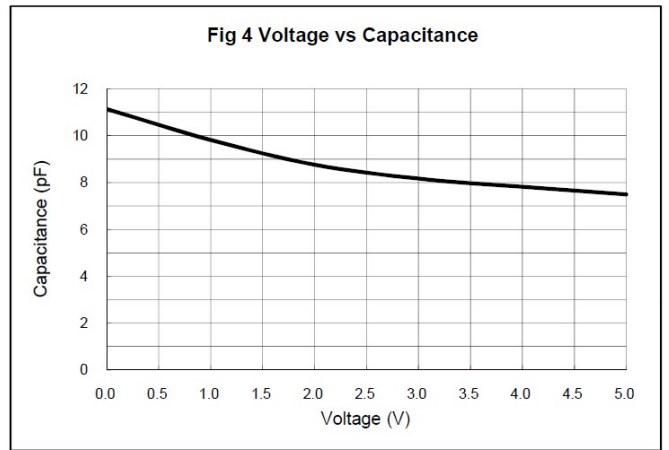
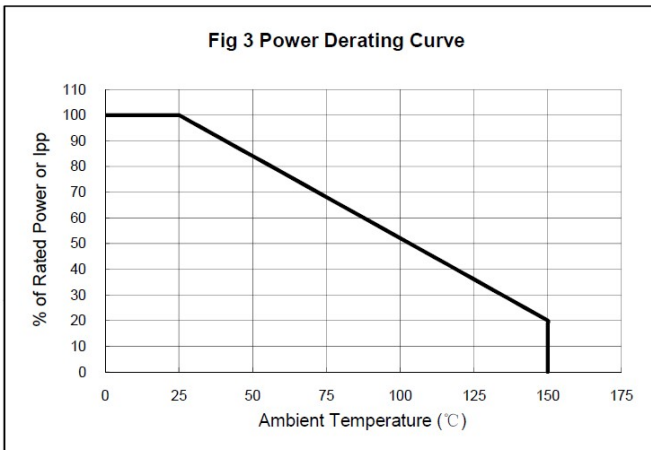
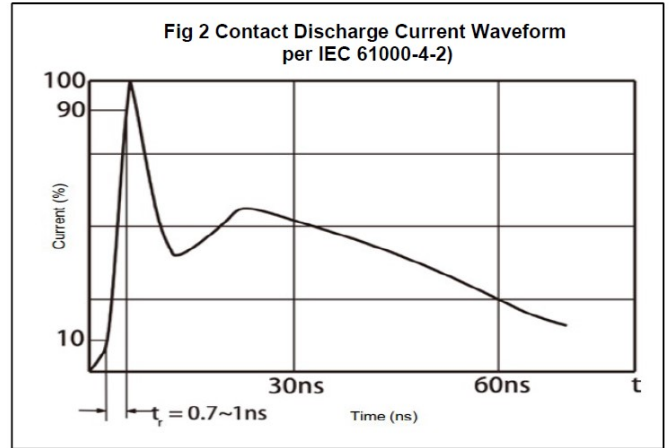
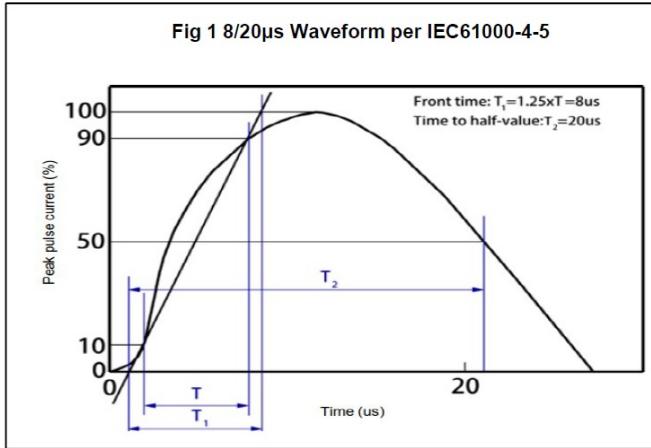

The curve above is for reference only.

Outline Drawing

SOD-323 Package Outline Dimensions

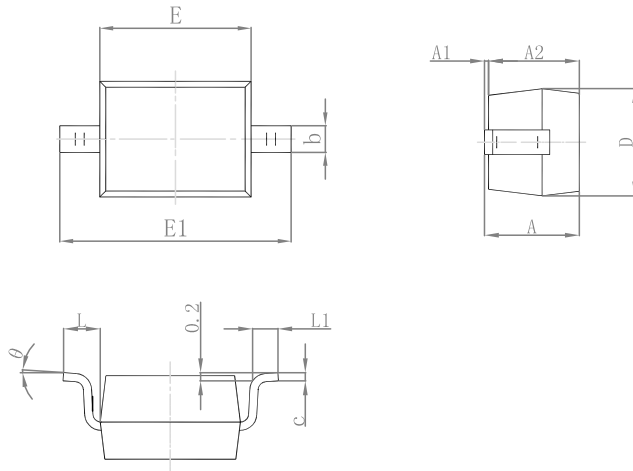

Symbol	Dimensions In Millimeters		Dimensions In Inches	
	Min.	Max.	Min.	Max.
A		1.000		0.039
A1	0.000	0.100	0.000	0.004
A2	0.800	0.900	0.031	0.035
b	0.250	0.350	0.010	0.014
c	0.080	0.150	0.003	0.006
D	1.200	1.400	0.047	0.055
E	1.600	1.800	0.063	0.071
E1	2.550	2.750	0.100	0.108
L	0.475 REF.		0.019 REF.	
L1	0.250	0.400	0.010	0.016
θ	0°		8°	

Suggested Pad Layout

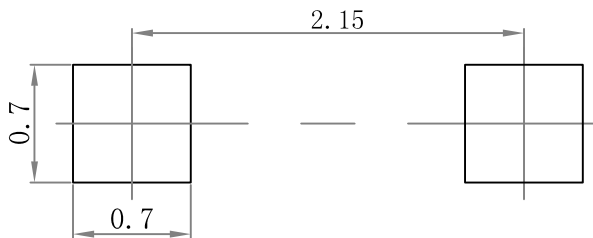

Note:

1. Controlling dimension: in/millimeters.
2. General tolerance: ± 0.05 mm.
3. The pad layout is for reference purposes only.

PACKAGE SPECIFICATIONS

Package	Reel Size	Reel DIA. (mm)	Q'TY/Reel (pcs)	Box Size (mm)	QTY/Box (pcs)	Carton Size (mm)	Q'TY/Carton (pcs)
SOD-323	7'	178	3000	183×188×80	45,000	386×265×215	180,000