

SOT-89 Plastic-Encapsulate Voltage Regulators
79L06 Three-terminal positive voltage regulator

SOT-89-3L
FEATURES

- Maximum output current
 I_{OM} : 0.1A
- Output voltage
 V_o : -6V
- Continuous total dissipation
 P_D : 0.6 W ($T_a=25^\circ\text{C}$)

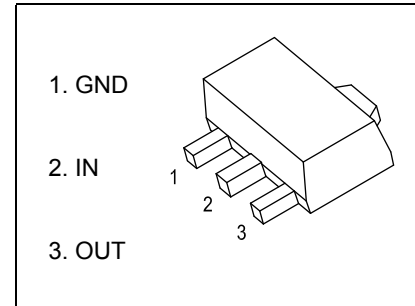

ABSOLUTE MAXIMUM RATINGS (Operating temperature range applies unless otherwise specified)

Parameter	Symbol	Value	Unit
Input Voltage	V_i	-35	V
Thermal Resistance from Junction to Ambient	$R_{\theta JA}$	208.3	$^\circ\text{C/W}$
Operating Junction Temperature Range	T_{OPR}	0~+150	$^\circ\text{C}$
Storage Temperature Range	T_{STG}	-65~+150	$^\circ\text{C}$

ELECTRICAL CHARACTERISTICS AT SPECIFIED VIRTUAL JUNCTION TEMPERATURE ($V_i=-11\text{V}, I_o=40\text{mA}, C_i=0.33\mu\text{F}, C_o=0.1\mu\text{F}$, unless otherwise specified)

Parameter	mbol	Test conditions	Mj	Tnd	Max	Unit	
Output Voltage	V_o	25°C	-5.76	-6.0	-6.24	V	
		0-125 $^\circ\text{C}$	-8V $\leq V_i \leq$ -20V, $I_o=1\text{mA}\sim 40\text{mA}$	-5.70	-6.0	-6.30	V
			$I_o=1\text{mA}\sim 70\text{mA}$	-5.70	-6.0	-6.30	V
Load Regulation	ΔV_o	$I_o=1\text{mA}\sim 100\text{mA}$, 25°C		21	80	mV	
		$I_o=1\text{mA}\sim 40\text{mA}$, 25°C		11	40	mV	
Line Regulation	ΔV_o	-8V $\leq V_i \leq$ -20V, 25°C		20	175	mV	
		-9V $\leq V_i \leq$ -20V, 25°C		15	125	mV	
Quiescent Current	I_q	25°C		3.9	6	mA	
Quiescent Current Change	ΔI_q	-9V $\leq V_i \leq$ -20V, 0-125 $^\circ\text{C}$			1.5	mA	
		1mA $\leq I_o \leq$ 40mA, 0-125 $^\circ\text{C}$			0.1	mA	
Output Noise Voltage	V_N	10Hz $\leq f \leq$ 100KHz, 25°C		44		$\mu\text{V}/V_o$	
Ripple Rejection	RR	-9V $\leq V_i \leq$ -19V, $f=120\text{Hz}$, 0-125 $^\circ\text{C}$	40	48		dB	
Dropout Voltage	V_d	25°C		1.7		V	

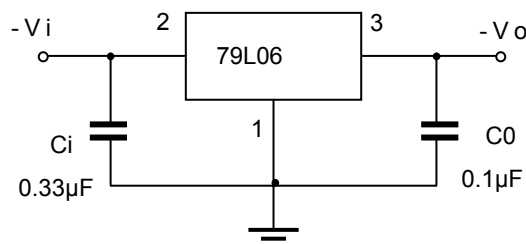
* Pulse test.

TYPICAL APPLICATION

Note: Bypass capacitors are recommended for optimum stability and transient response and should be located as close as possible to the regulators.



Typical Characteristics

Output Characteristics

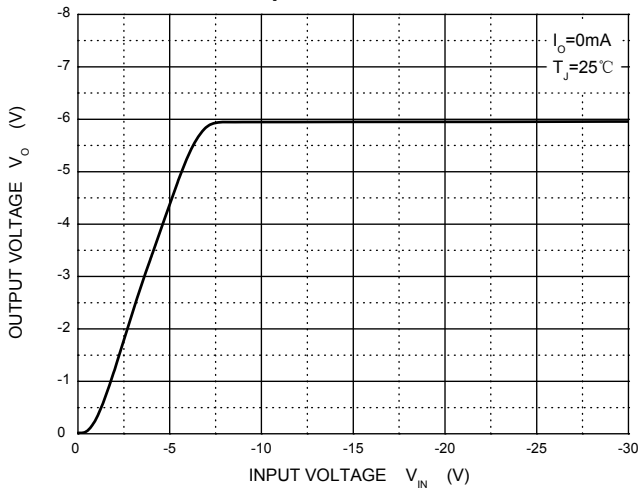

Dropout Characteristics

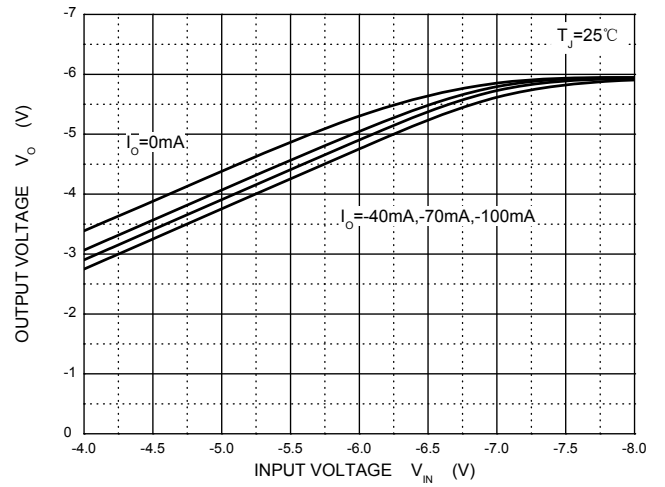

Quiescent Current vs Input Voltage

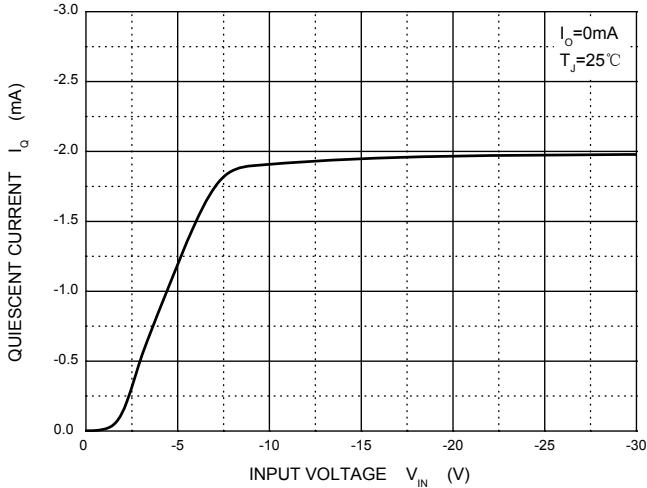

Current Cut-off Grid Voltage

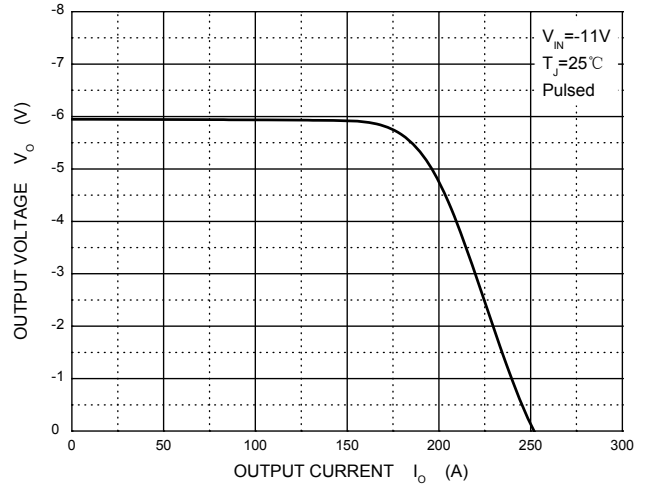

Output Voltage vs Junction Temperature

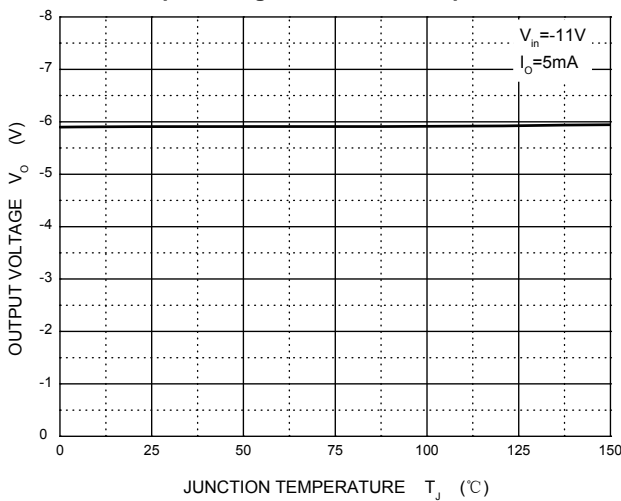

Power Derating Curve

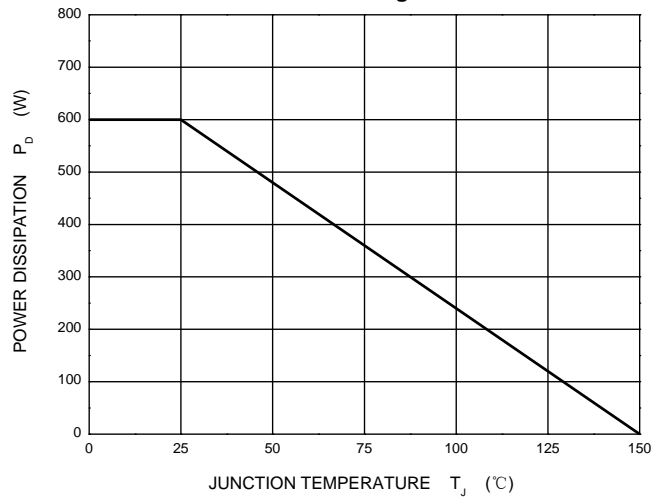

Outlitne Drawing

SOT-89-3L Package Outline Dimensions

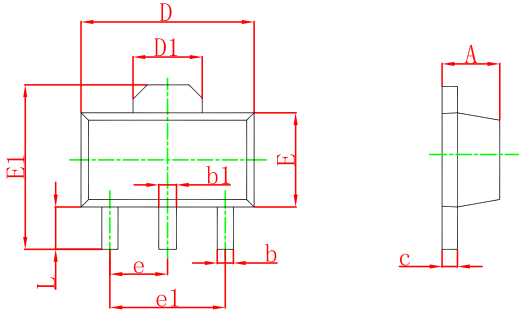

Symbol	Dimensions In Millimeters		Dimensions In Inches	
	Min	Max	Min	Max
A	1.400	1.600	0.055	0.063
b	0.320	0.520	0.013	0.020
b1	0.400	0.580	0.016	0.023
c	0.350	0.440	0.014	0.017
D	4.400	4.600	0.173	0.181
D1	1.550 REF.		0.061 REF.	
E	2.300	2.600	0.091	0.102
E1	3.940	4.250	0.155	0.167
e	1.500 TYP.		0.060 TYP.	
e1	3.000 TYP.		0.118 TYP.	
L	0.900	1.200	0.035	0.047

SOT-89-3L Suggested Pad Layout

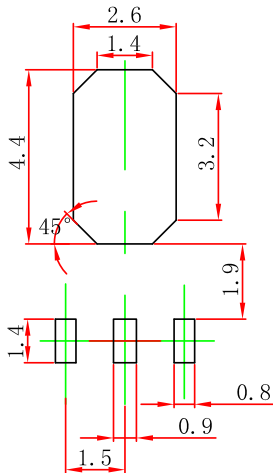

Note:

1. Controlling dimension: in/millimeters.
2. General tolerance: ±0.05mm.
3. The pad layout is for reference purposes only.

PACKAGE SPECIFICATIONS

Package	Reel Size	Reel DIA. (mm)	Q'TY/Reel (pcs)	Box Size (mm)	QTY/Box (pcs)	Carton Size (mm)	G.W.(Kg)
SOT-89-3L	7'	330	1000	203×203×195	40000	438×438×220	180000