

**SOT-89 Plastic-Encapsulate Voltage Regulators**
**78L09** Three-terminal positive voltage regulator

**SOT-89-3L**
**FEATURES**

- Maximum output current  
 $I_{OM}$ : 0.1A
- Output voltage  
 $V_O$ : 9V
- Continuous total dissipation  
 $P_D$ : 0.6 W ( $T_a = 25^\circ\text{C}$ )

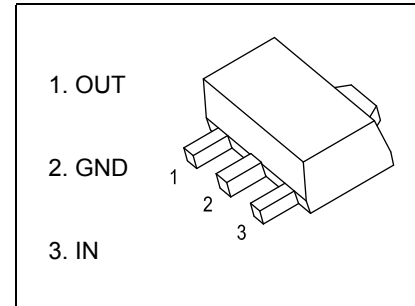

**ABSOLUTE MAXIMUM RATINGS (Operating temperature range applies unless otherwise specified)**

Parameter	Symbol	Value	Unit
Input Voltage	$V_i$	30	V
Thermal Resistance from Junction to Ambient	$R_{\theta JA}$	166.7	$^\circ\text{C}/\text{W}$
Operating Junction Temperature Range	$T_{OPR}$	-40~+125	$^\circ\text{C}$
Storage Temperature Range	$T_{STG}$	-65~+150	$^\circ\text{C}$

**ELECTRICAL CHARACTERISTICS AT SPECIFIED VIRTUAL JUNCTION TEMPERATURE ( $V_i=16\text{V}, I_o=40\text{mA}, C_i=0.33\mu\text{F}, C_o=0.1\mu\text{F}$ , unless otherwise specified )**

Parameter	Symbol	Test conditions	Min	Typ	Max	Unit	
Output voltage	$V_o$	$25^\circ\text{C}$	8.73	9.0	9.27	V	
		0-125 $^\circ\text{C}$	$12\text{V} \leq V_i \leq 24\text{V}, I_o=1\text{mA}-40\text{mA}$	8.55	9.0	9.45	V
			$I_o=1\text{mA}-70\text{mA}$	8.55	9.0	9.45	V
Load Regulation	$\Delta V_o$	$I_o=1\text{mA}-100\text{mA}$	$25^\circ\text{C}$	19	90	mV	
		$I_o=1\text{mA}-40\text{mA}$	$25^\circ\text{C}$	11	40	mV	
Line regulation	$\Delta V_o$	$12\text{V} \leq V_i \leq 24\text{V}$	$25^\circ\text{C}$	45	175	mV	
		$13\text{V} \leq V_i \leq 24\text{V}$	$25^\circ\text{C}$	40	125	mV	
Quiescent Current	$I_q$	$25^\circ\text{C}$	4.1	6.0	mA		
Quiescent Current Change	$\Delta I_q$	$13\text{V} \leq V_i \leq 24\text{V}$	0-125 $^\circ\text{C}$		1.5	mA	
	$\Delta I_q$	$1\text{mA} \leq I_o \leq 40\text{mA}$	0-125 $^\circ\text{C}$		0.1	mA	
Output Noise Voltage	$V_N$	$10\text{Hz} \leq f \leq 100\text{KHz}$	$25^\circ\text{C}$	58		$\mu\text{V}/V_o$	
Ripple Rejection	RR	$15\text{V} \leq V_i \leq 25\text{V}, f=120\text{Hz}$	0-125 $^\circ\text{C}$	45		dB	
Dropout Voltage	$V_d$	$25^\circ\text{C}$		1.7		V	

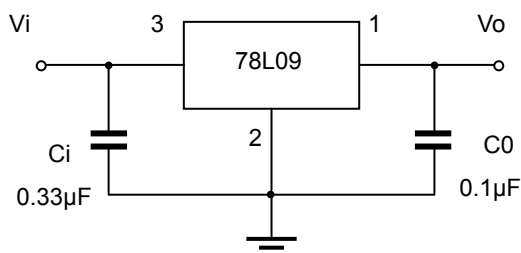
\* Pulse test.

**TYPICAL APPLICATION**

Note: Bypass capacitors are recommended for optimum stability and transient response and should be located as close as possible to the regulator pins.

Typical Characteristics

Output Characteristics

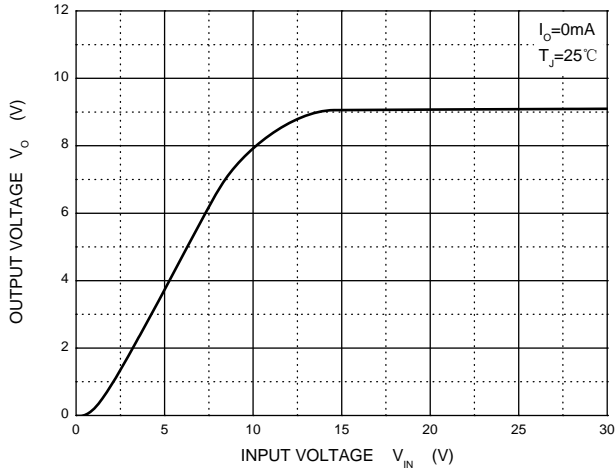

Dropout Characteristics

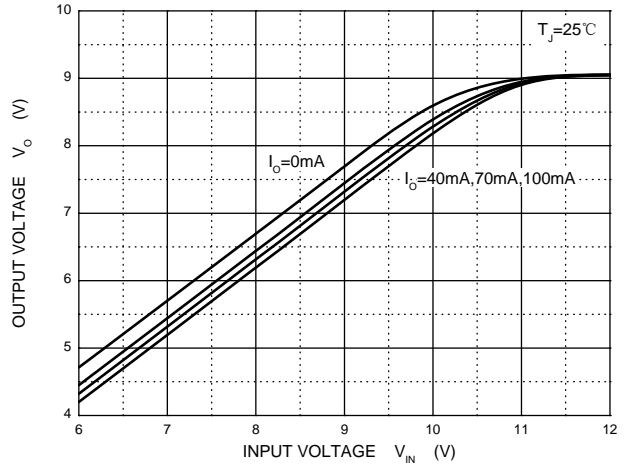

Quiescent Current vs Input Voltage

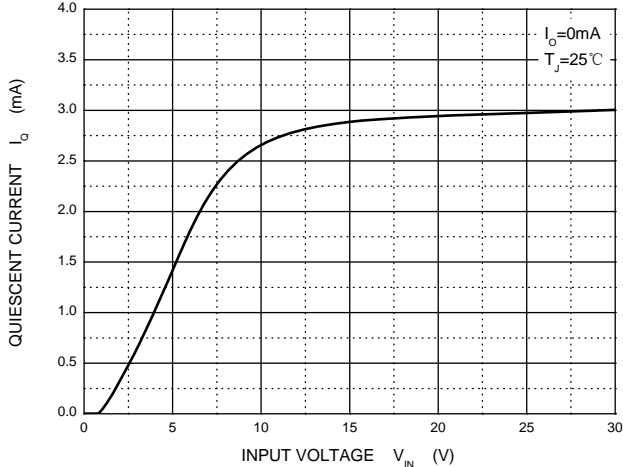

Current Cut-off Grid Voltage

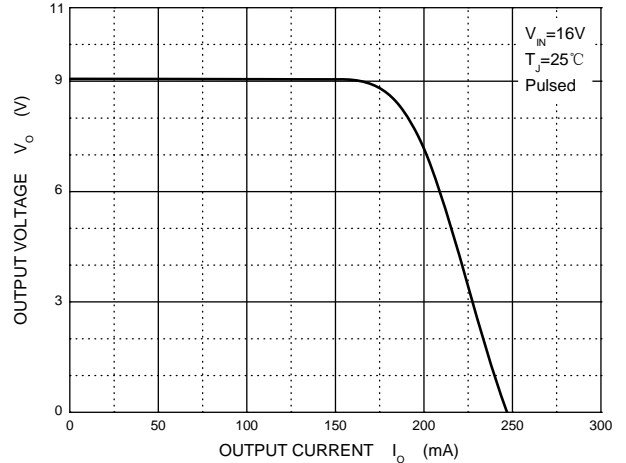

Output Voltage vs Junction Temperature

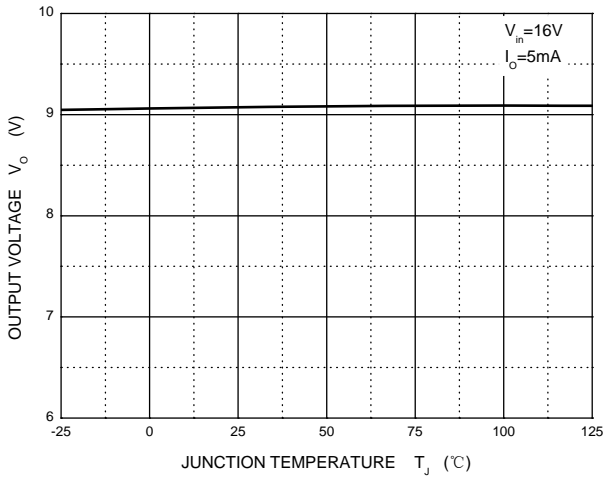

Power Derating Curve

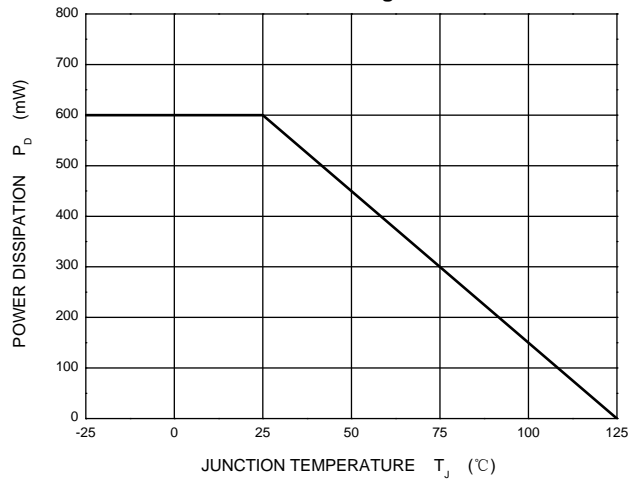

**Outline Drawing**

**SOT-89-3L Package Outline Dimensions**

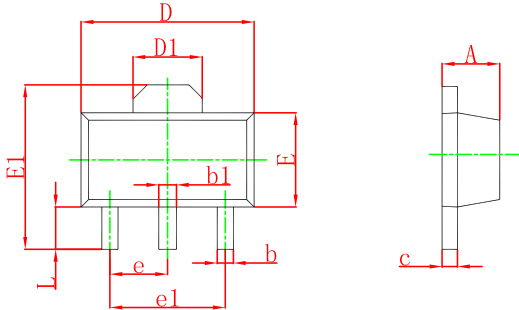

Symbol	Dimensions In Millimeters		Dimensions In Inches	
	Min	Max	Min	Max
A	1.400	1.600	0.055	0.063
b	0.320	0.520	0.013	0.020
b1	0.400	0.580	0.016	0.023
c	0.350	0.440	0.014	0.017
D	4.400	4.600	0.173	0.181
D1	1.550 REF.		0.061 REF.	
E	2.300	2.600	0.091	0.102
E1	3.940	4.250	0.155	0.167
e	1.500 TYP.		0.060 TYP.	
e1	3.000 TYP.		0.118 TYP.	
L	0.900	1.200	0.035	0.047

**SOT-89-3L Suggested Pad Layout**

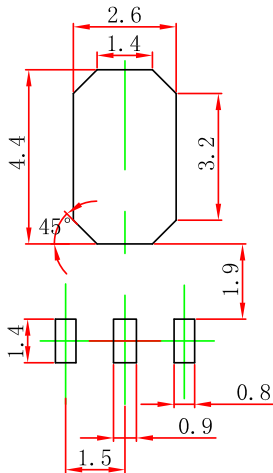

Note:

1. Controlling dimension: in/millimeters.
2. General tolerance: ±0.05mm.
3. The pad layout is for reference purposes only.

**PACKAGE SPECIFICATIONS**

Package	Reel Size	Reel DIA. (mm)	Q'TY/Reel (pcs)	Box Size (mm)	QTY/Box (pcs)	Carton Size (mm)	G.W.(Kg)
SOT-89-3L	7'	330	1000	203×203×195	40000	438×438×220	180000