

SOT-23 Plastic-Encapsulate Transistors

MMBT3904 TRANSISTOR (NPN)

FEATURES

- Complementary Type The PNP Transistor MMBT3906 is Recommended
- Epitaxial Planar Die Construction

MAXIMUM RATINGS ($T_a=25^{\circ}\text{C}$ unless otherwise noted)

Symbol	Parameter	Value	Unit
V_{CB0}	Collector-Base Voltage	60	V
V_{CEO}	Collector-Emitter Voltage	40	V
V_{EBO}	Emitter-Base Voltage	6	V
I_C	Collector Current	200	mA
P_C	Collector Power Dissipation	200	mW
$R_{\theta JA}$	Thermal Resistance From Junction To Ambient	625	$^{\circ}\text{C}/\text{W}$
T_j	Junction Temperature	150	$^{\circ}\text{C}$
T_{stg}	Storage Temperature	-55~+150	$^{\circ}\text{C}$

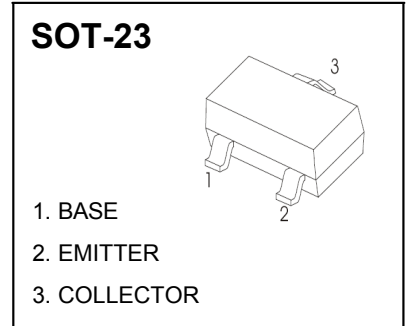

MARKING: 1AM

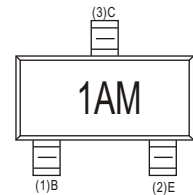

ELECTRICAL CHARACTERISTICS ($T_a=25^{\circ}\text{C}$ unless otherwise specified)

Parameter	Symbol	Test conditions	Min	Typ	Max	Unit
Collector-base breakdown voltage	$V_{(BR)CBO}$	$I_C=10\mu\text{A}$, $I_E=0$	60			V
Collector-emitter breakdown voltage	$V_{(BR)CEO}$	$I_C=1\text{mA}$, $I_B=0$	40			V
Emitter-base breakdown voltage	$V_{(BR)EBO}$	$I_E=10\mu\text{A}$, $I_C=0$	6			V
Collector cut-off current	I_{CEX}	$V_{CE}=30\text{V}$, $V_{EB(off)}=3\text{V}$			50	nA
Collector cut-off current	I_{CBO}	$V_{CB}=60\text{V}$, $I_E=0$			100	nA
Emitter cut-off current	I_{EBO}	$V_{EB}=5\text{V}$, $I_C=0$			100	nA
DC current gain	$h_{FE(1)}$	$V_{CE}=1\text{V}$, $I_C=10\text{mA}$	100		300	
	$h_{FE(2)}$	$V_{CE}=1\text{V}$, $I_C=50\text{mA}$	60			
	$h_{FE(3)}$	$V_{CE}=1\text{V}$, $I_C=100\text{mA}$	30			
Collector-emitter saturation voltage	$V_{CE(sat)}$	$I_C=50\text{mA}$, $I_B=5\text{mA}$			0.3	V
Base-emitter saturation voltage	$V_{BE(sat)}$	$I_C=50\text{mA}$, $I_B=5\text{mA}$			0.95	V
Transition frequency	f_T	$V_{CE}=20\text{V}$, $I_C=10\text{mA}$, $f=100\text{MHz}$	300			MHz
Delay time	t_d	$V_{CC}=3\text{V}$, $V_{BE(off)}=-0.5\text{V}$, $I_C=10\text{mA}$, $I_{B1}=1\text{mA}$			35	ns
Rise time	t_r	$V_{CC}=3\text{V}$, $V_{BE(off)}=-0.5\text{V}$, $I_C=10\text{mA}$, $I_{B1}=1\text{mA}$			35	ns
Storage time	t_s	$V_{CC}=3\text{V}$, $I_C=10\text{mA}$, $I_{B1}=I_{B2}=1\text{mA}$			200	ns
Fall time	t_f	$V_{CC}=3\text{V}$, $I_C=10\text{mA}$, $I_{B1}=I_{B2}=1\text{mA}$			50	ns

CLASSIFICATION OF h_{FE}

RANK	O	Y
RANGE	100 - 200	200 - 300

Typical Characteristics

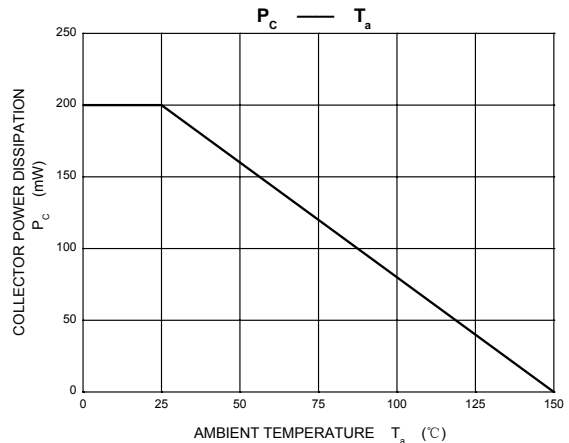
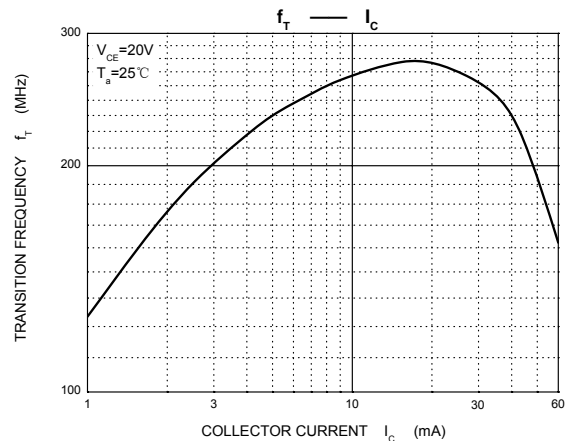
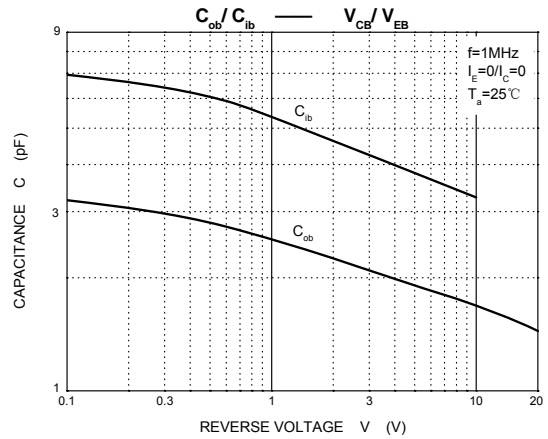
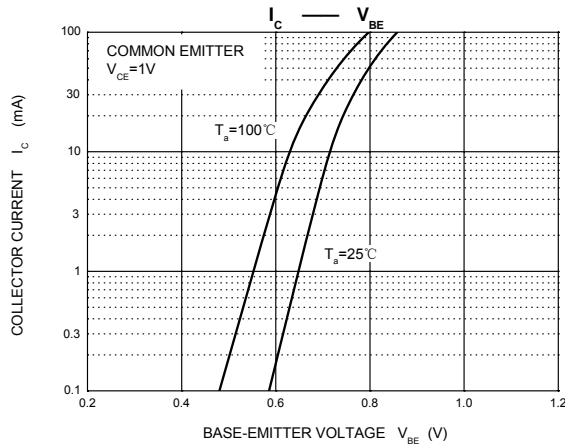
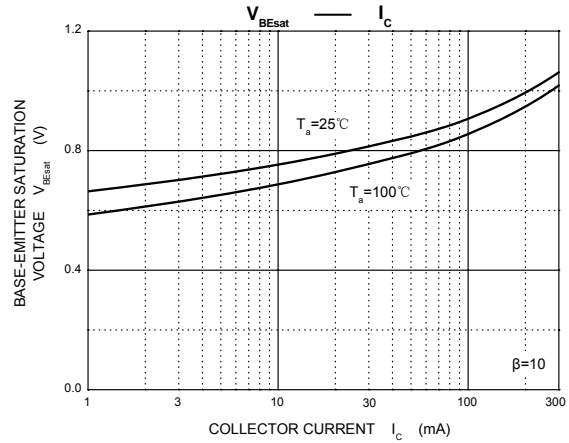
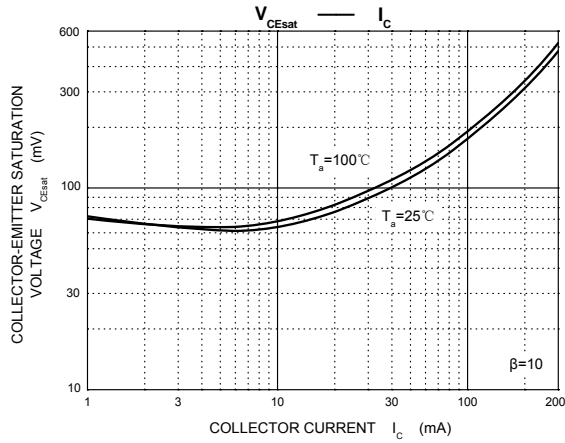
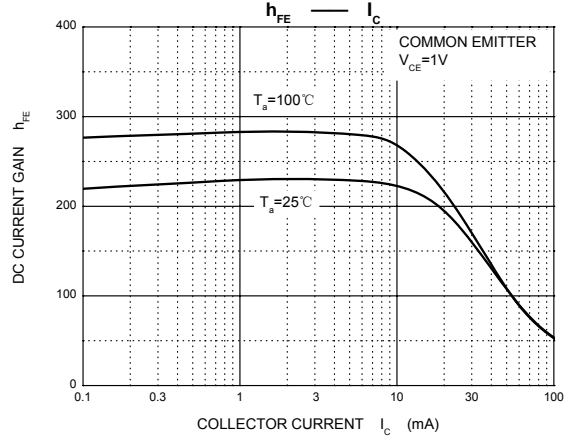
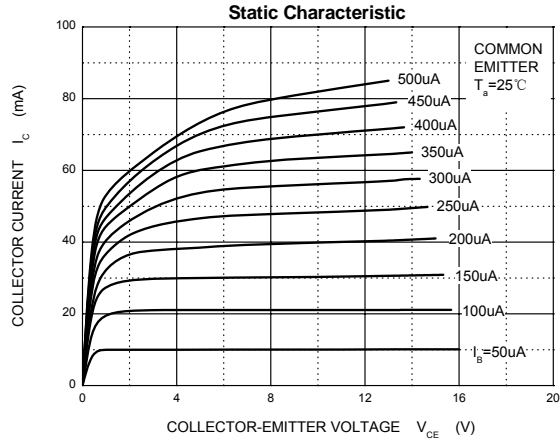

Outline Drawing

SOT-23 Package Outline Dimensions

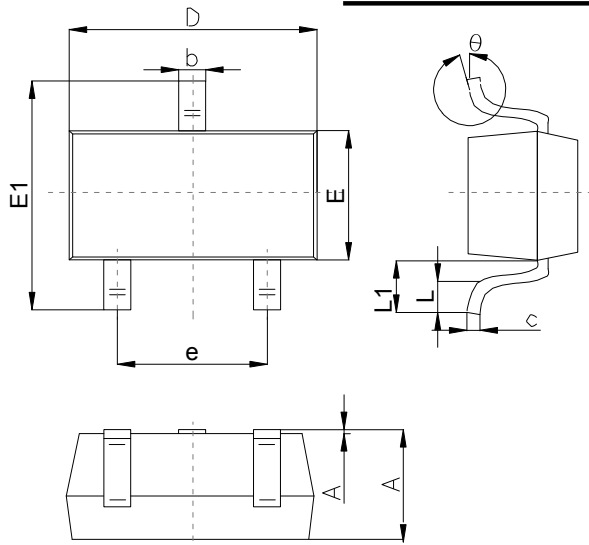

Symbol	Dimensions In Millimeters		
	Min	Typ	Max
A	0.90		1.40
A1	0.00		0.10
b	0.30		0.50
c	0.08		0.20
D	2.80	2.90	3.10
E	1.20		1.60
E1	2.25		2.80
e	1.80	1.90	2.00
L	0.10		0.50
L1	0.4		0.55
θ	0°		10°

Suggested Pad Layout

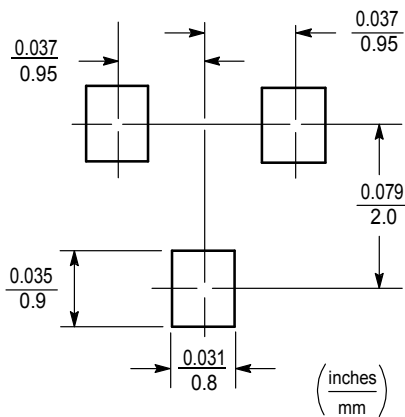

Note:

1. Controlling dimension:in/millimeters.
2. General tolerance: ±0.05mm.
3. The pad layout is for reference purposes only.

SOT-23 Tape and Reel

SOT-23 Embossed Carrier Tape

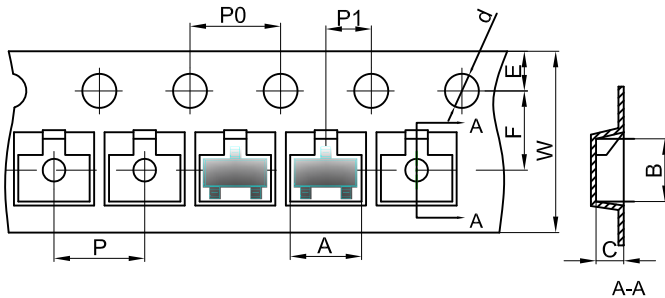

Packaging Description:

SOT-23 parts are shipped in tape. The carrier tape is made from a dissipative (carbon filled) polycarbonate resin. The cover tape is a multilayer film (Heat Activated Adhesive in nature) primarily composed of polyester film, adhesive layer, sealant, and anti-static sprayed agent. These reeled parts in standard option are shipped with 3,000 units per 7" or 17.8cm diameter reel. The reels are clear in color and is made of polystyrene plastic (anti-static coated).

Dimensions are in millimeter										
Pkg type	A	B	C	d	E	F	P0	P	P1	W
SOT-23	3.15	2.77	1.22	Ø1.50	1.75	3.50	4.00	4.00	2.00	8.00

SOT-23 Tape Leader and Trailer

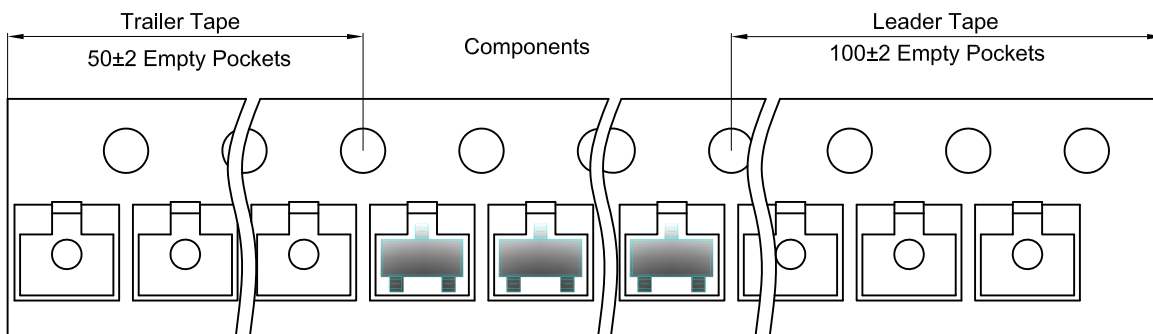

SOT-23 Reel

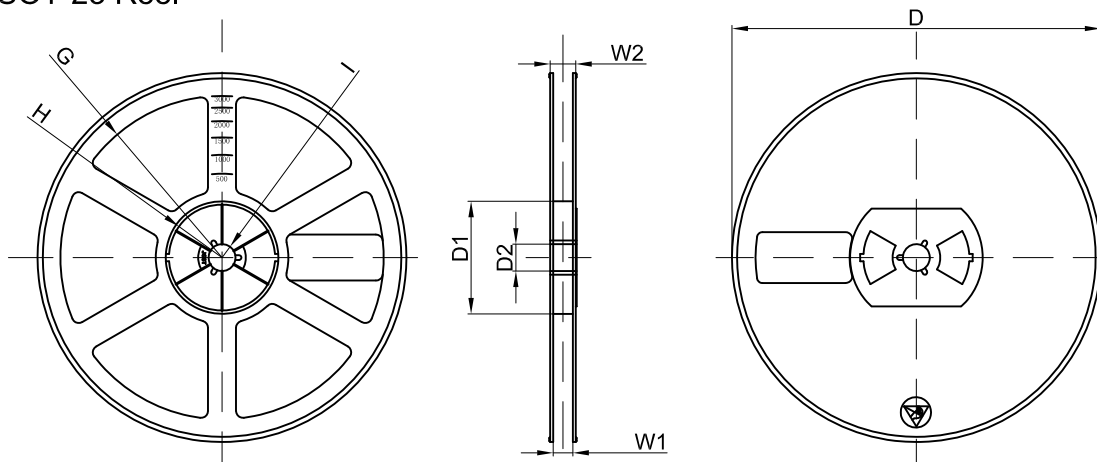

Dimensions are in millimeter								
Reel Option	D	D1	D2	G	H	I	W1	W2
7" Dia	Ø178.00	54.40	13.00	R78.00	R25.60	R6.50	9.50	12.30

REEL	Reel Size	Box	Box Size(mm)	Carton	Carton Size(mm)	G.W.(kg)
3000 pcs	7 Inch	45,000 pcs	203×203×195	180,000 pcs	438×438×220	