

SOT-23 Plastic-Encapsulate Transistors

S8550 TRANSISTOR (PNP)

FEATURES

- Complimentary to S8050
- Collector Current: $I_C=0.5A$

MARKING: 2TY

MAXIMUM RATINGS ($T_a=25^\circ C$ unless otherwise noted)

Symbol	Parameter	Value	Unit
V_{CB0}	Collector-Base Voltage	-40	V
V_{CEO}	Collector-Emitter Voltage	-25	V
V_{EBO}	Emitter-Base Voltage	-5	V
I_C	Collector Current-Continuous	-0.5	A
P_C	Collector Power Dissipation	0.3	W
T_j	Junction Temperature	150	$^\circ C$
T_{stg}	Storage Temperature	-55~+150	$^\circ C$

SOT-23

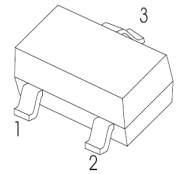

1. BASE
2. EMITTER
3. COLLECTOR

ELECTRICAL CHARACTERISTICS ($T_a=25^\circ C$ unless otherwise specified)

Parameter	Symbol	Test conditions	Min	Typ	Max	Unit
Collector-base breakdown voltage	$V_{(BR)CBO}$	$I_C=-100\mu A, I_E=0$	-40			V
Collector-emitter breakdown voltage	$V_{(BR)CEO}$	$I_C=-1mA, I_B=0$	-25			V
Emitter-base breakdown voltage	$V_{(BR)EBO}$	$I_E=-100\mu A, I_C=0$	-5			V
Collector cut-off current	I_{CBO}	$V_{CB}=-40V, I_E=0$			-0.1	μA
Collector cut-off current	I_{CEO}	$V_{CB}=-20V, I_E=0$			-0.1	μA
Emitter cut-off current	I_{EBO}	$V_{EB}=-3V, I_C=0$			-0.1	μA
DC current gain	$h_{FE(1)}$	$V_{CE}=-1V, I_C=-50mA$	120		400	
	$h_{FE(2)}$	$V_{CE}=-1V, I_C=-500mA$	50			
Collector-emitter saturation voltage	$V_{CE(sat)}$	$I_C=-500mA, I_B=-50mA$			-0.6	V
Base-emitter saturation voltage	$V_{BE(sat)}$	$I_C=-500mA, I_B=-50mA$			-1.2	V
Transition frequency	f_T	$V_{CE}=-6V, I_C=-20mA, f=30MHz$	150			MHz

CLASSIFICATION OF $h_{FE(1)}$

Rank	L	H	J
Range	120-200	200-350	300-400

Typical Characteristics

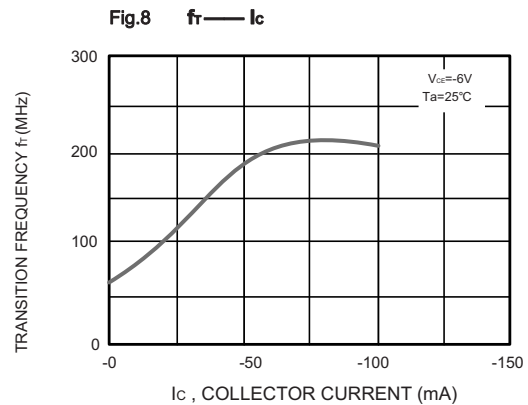
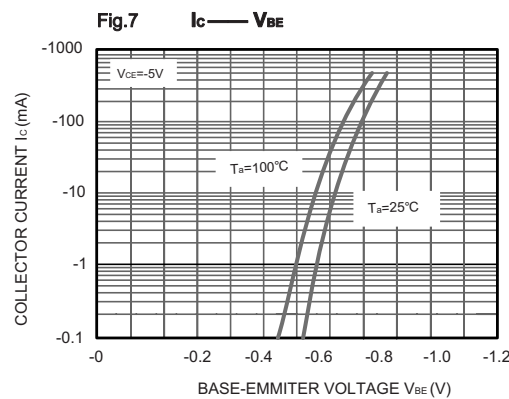
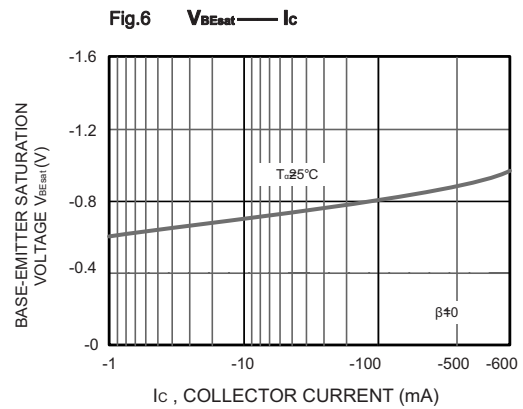
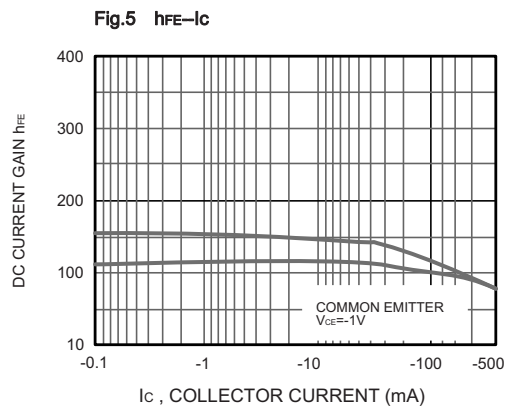
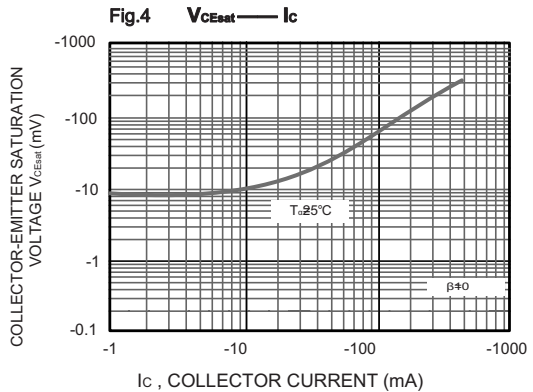
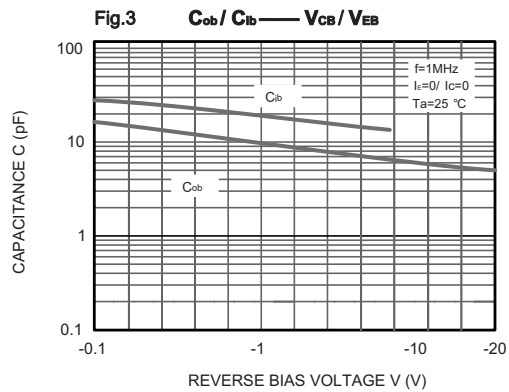
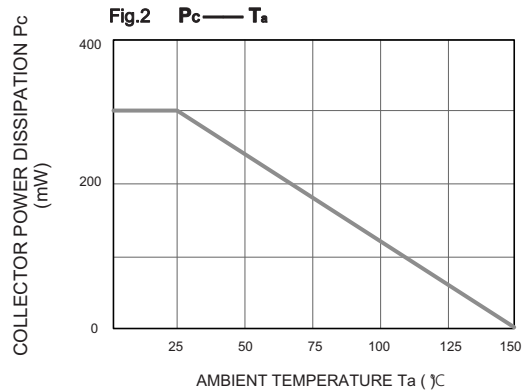
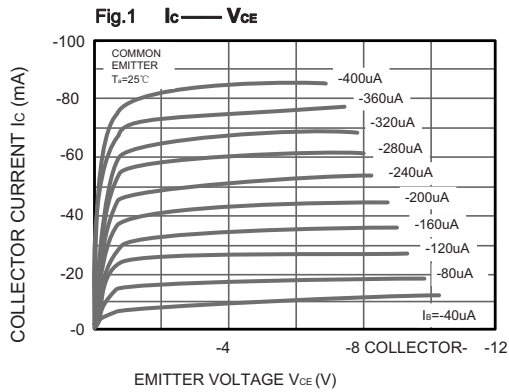

Outlitne Drawing

SOT-23 Package Outline Dimensions

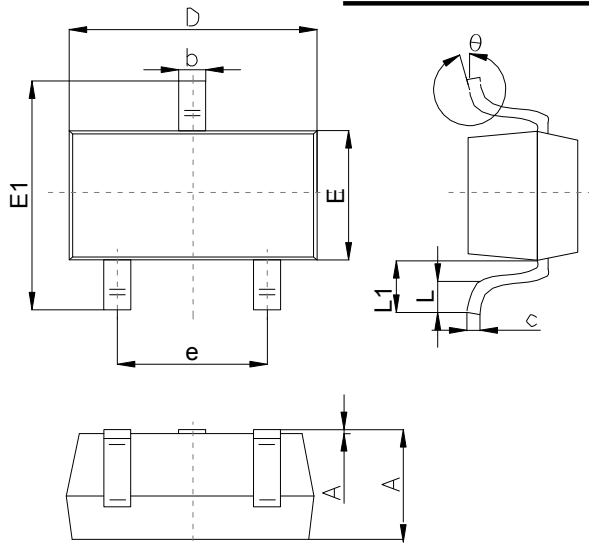

Symbol	Dimensions In Millimeters		
	Min	Typ	Max
A	0.90		1.40
A1	0.00		0.10
b	0.30		0.50
c	0.08		0.20
D	2.80	2.90	3.10
E	1.20		1.60
E1	2.25		2.80
e	1.80	1.90	2.00
L	0.10		0.50
L1	0.4		0.55
θ	0°		10°

Suggested Pad Layout

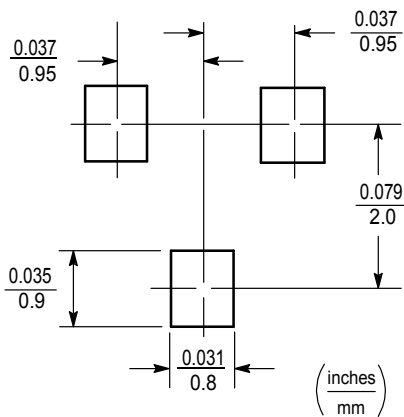

Note:

1. Controlling dimension:in/millimeters.
2. General tolerance: ±0.05mm.
3. The pad layout is for reference purposes only.

SOT-23 Tape and Reel

SOT-23 Embossed Carrier Tape

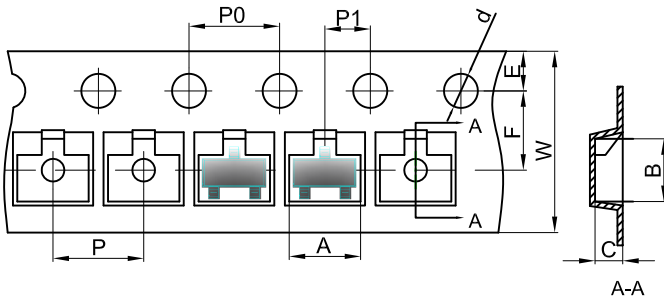

Packaging Description:

SOT-23 parts are shipped in tape. The carrier tape is made from a dissipative (carbon filled) polycarbonate resin. The cover tape is a multilayer film (Heat Activated Adhesive in nature) primarily composed of polyester film, adhesive layer, sealant, and anti-static sprayed agent. These reeled parts in standard option are shipped with 3,000 units per 7" or 17.8cm diameter reel. The reels are clear in color and is made of polystyrene plastic (anti-static coated).

Dimensions are in millimeter										
Pkg type	A	B	C	d	E	F	P0	P	P1	W
SOT-23	3.15	2.77	1.22	Ø1.50	1.75	3.50	4.00	4.00	2.00	8.00

SOT-23 Tape Leader and Trailer

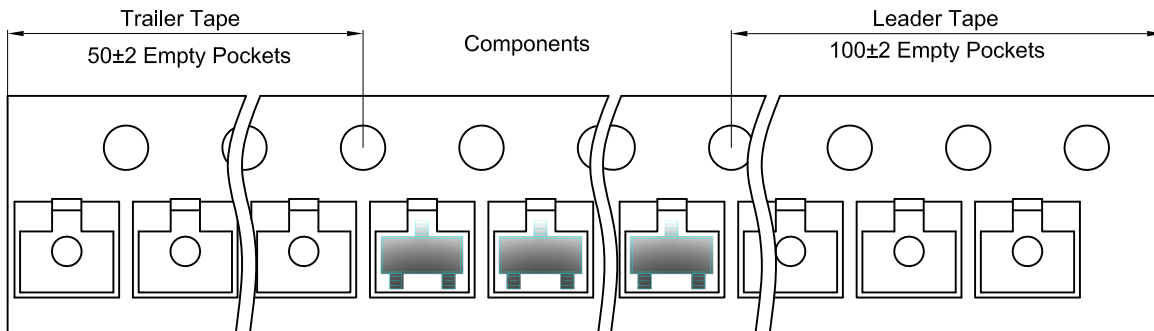

SOT-23 Reel

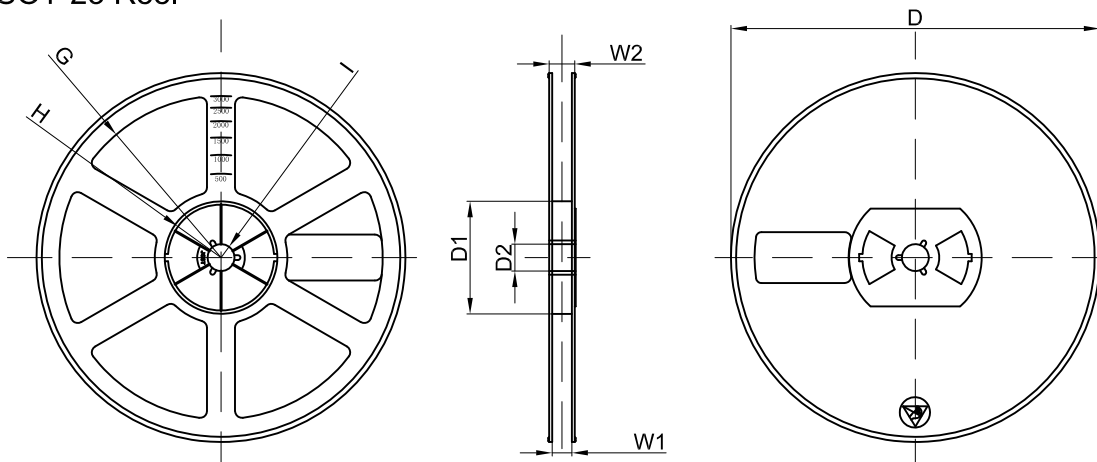

Dimensions are in millimeter								
Reel Option	D	D1	D2	G	H	I	W1	W2
7" Dia	Ø178.00	54.40	13.00	R78.00	R25.60	R6.50	9.50	12.30

REEL	Reel Size	Box	Box Size(mm)	Carton	Carton Size(mm)	G.W.(kg)
3000 pcs	7 Inch	45,000 pcs	203×203×195	180,000 pcs	438×438×220	