

SOD-323 Plastic-Encapsulate Diode

BAS70WS SCHOTTKY BARRIER DIODE

SOD-323



FEATURES

- Low power loss, high efficiency
- High current capability
- High surge capability
- Fast Switching Speed

Marking

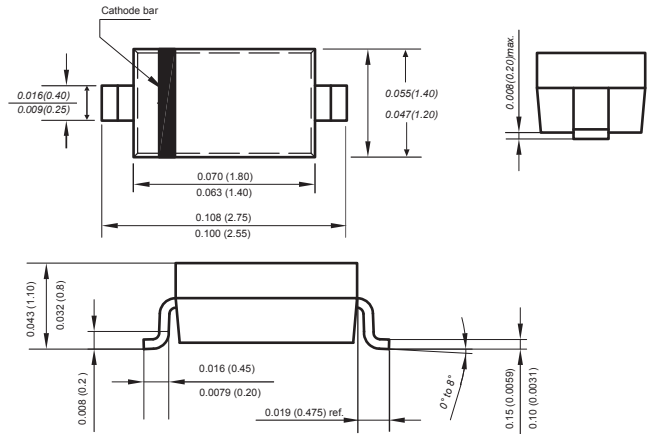

Mechanical Data

Case : SOD-323

Terminals : Solderable per MIL-STD-750, Method 2026

Polarity : Polarity symbol marking on body

Mounting Position : Any

Weight : 0.00019 ounce, 0.00548 grams

Dimensions in inches and (millimeters)

Maximum Ratings and Electrical Characteristics, Single Diode @Ta=25°C

Parameter	Symbo	Limit	Unit
Peak Repetitive Peak Reverse Voltage	V_{RRM}	70	V
Working Peak Reverse Voltage	V_{RWM}		
DC Blocking Voltage	V_R		
Average Rectified Output Current Ta=25°C	I_O	200	mA
Peak Forward Surge Current, 8.3ms single half sine-wave superimposed on rated load (JEDEC method)	I_{FSM}	25	A
Power Dissipation	P_{TOT}	225	mW
Thermal Resistance Junction to Ambient	$R_{\theta JA}$	625	°C/W
Junction Temperature	T_j	150	°C
Storage Temperature	T_{STG}	-55~+150	°C

ELECTRICAL CHARACTERISTICS (Ta=25°C unless otherwise specified)

Parameter	Symbol	Test conditions	Min	Max	Unit
Reverse breakdown voltage	$V_{(BR)}$	$I_R=10\mu A$	70		V
Reverse voltage leakage current	I_R	$V_R=50V$ $V_R=70V$		0.1 1.0	μA
Forward voltage	V_F	$I_F=1mA$ $I_F=10mA$ $I_F=15mA$		0.47 0.75 1.0	V
Typical Junction Capacitance	C_J	$V_R=0, f=1MHz$		30	pF
Reveres recovery time	t_{rr}	$I_F=I_R=10mA, I_{rr}=0.1 \times I_R,$ $R_L=100\Omega$		6	ns

The above data are for reference only.

Typical Characteristics

Fig.1 Forward Current Derating Curve

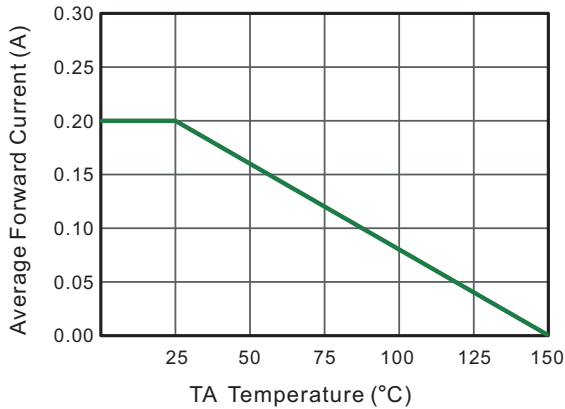

Fig.2 Typical Reverse Characteristics

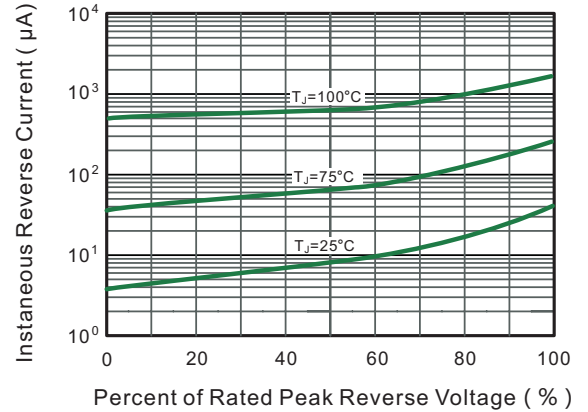

Fig.4 Typical Forward Characteristics

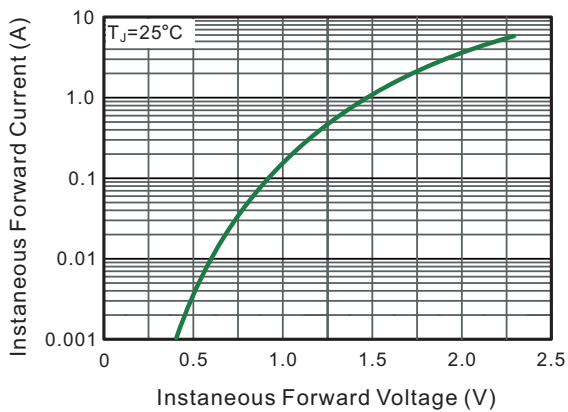

Fig.4 Typical Junction Capacitance

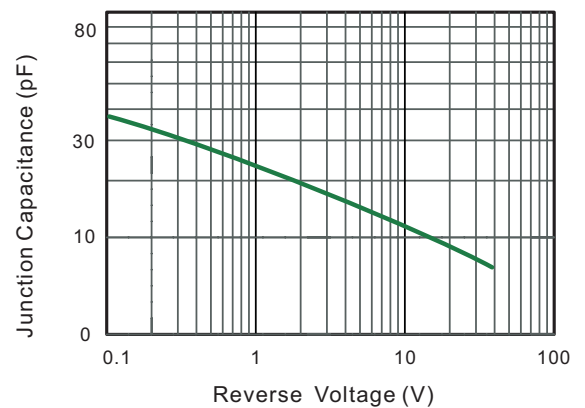

Fig.5 Maximum Non-Repetitive Peak Forward Surge Current

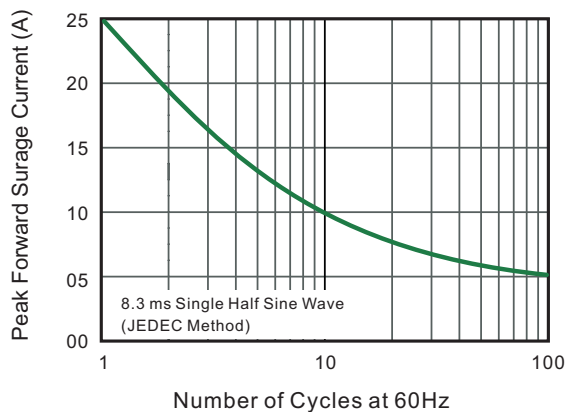
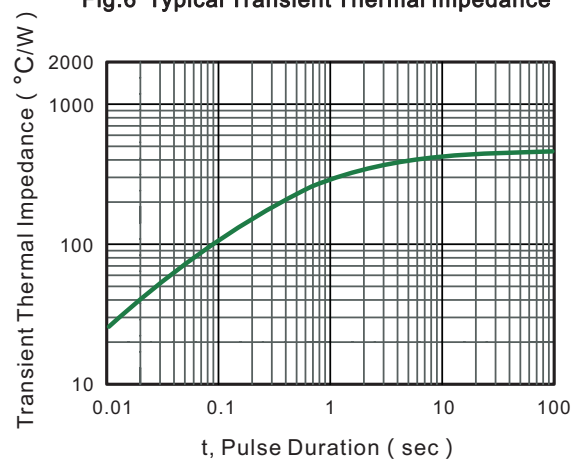
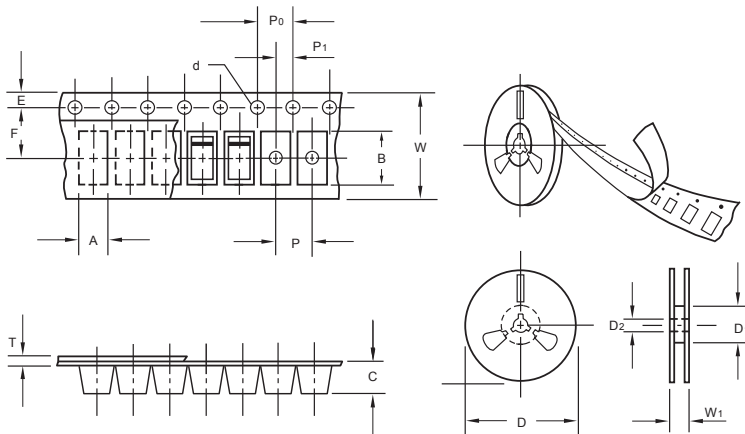

Fig.6 Typical Transient Thermal Impedance



The curve above is for reference only.

Packing information



unit:mm

Item	Symbol	Tolerance	SOD-323
Carrier width	A	0.1	1.46
Carrier length	B	0.1	2.90
Carrier depth	C	0.1	1.25
Sprocket hole	d	0.05	1.50
13" Reel outside diameter	D	2.0	330.00
13" Reel inner diameter	D ₁	min	50.00
7" Reel outside diameter	D	2.0	178.00
7" Reel inner diameter	D ₁	min	54.40
Feed hole diameter	D ₂	0.5	13.00
Sprocket hole position	E	0.1	1.75
Punch hole position	F	0.1	3.50
Punch hole pitch	P	0.1	4.00
Sprocket hole pitch	P ₀	0.1	4.00
Embossment center	P ₁	0.1	2.00
Overall tape thickness	T	0.1	0.06
Tape width	W	0.3	8.00
Reel width	W ₁	1.0	12.30

Note: Devices are packed in accordance with EIA standard RS-481-A and specifications listed above.

Reel packing

PACKAGE	REEL SIZE	REEL (pcs)	COMPONENT SPACING (m/m)	BOX (pcs)	INNER BOX (m/m)	REEL DIA. (m/m)	CARTON SIZE (m/m)	CARTON (pcs)	APPROX. GROSS WEIGHT (kg)
SOD-323	7"	3,000	4.0	45,000	210*208*203	178	430*430*235	180,000	9.0

Suggested Pad Layout

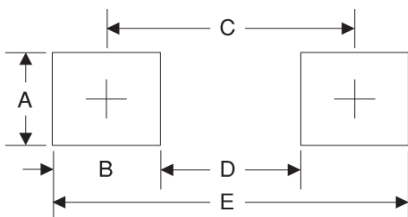

Symbol	Unit (mm)	Unit (inch)
A	1.2	0.047
B	1.2	0.047
C	2.6	0.102
D	1.4	0.055
E	3.8	0.149