

■ Features

- High density packaging with a pitch of 2.54mm(0.1 inch) max. is possible.
This series requires less space and has greater EMI suppression effects.
- Different types with the same shape are available.
- Excellent in physical properties, such as terminal strength, flexure strength, soldering resistance and solderability.
- Applicable to both flow and reflow soldering.
- High impedance cover wide frequency ranges.
- YI series can be used in high current circuits due to its low DC resistance.
- Operating temperature: -40°C ~ +125°C.

■ Applications

- Computers and peripheral devices, personal computers, VCR and cameras.
- Noise suppression in digital equipments, car stereo, car engines controllers and OA electronic instruments.
- Communication equipment.

■ Product Identification

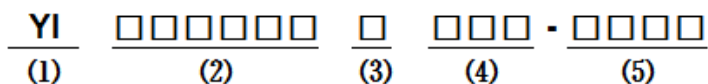

- (1) : Type
- (2) : Dimensions
- (3) : Material Code
- (4) : Impedance
- (5) : Rated Current

Shapes and Dimensions (Unit: mm)

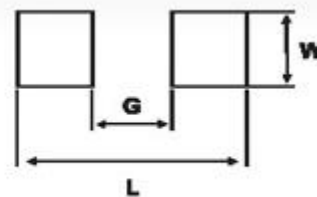
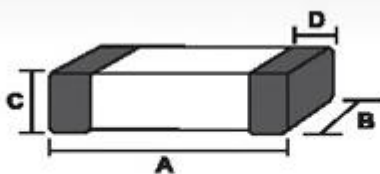

TYPE	A	B	C	D	L	W	G
YI201209	2.0±0.2	1.2±0.2	0.9±0.2	0.5±0.3	3.20	1.50	0.60

Electrical Requirements

Part Number	Impedance(Ω) ±25%	Test Freq. (MHz)	DCR MAX. (Ω)	Rating Current MAX (A)
YI201209U201-4R0T	200	100	0.035	4.0

TEST INSTRUMENTS:

HP 4338A MILLIOHM METER

HP 4291B RF IMPEDANCE/MATERIAL ANALYZER

Impedance VS. Frequency characteristic

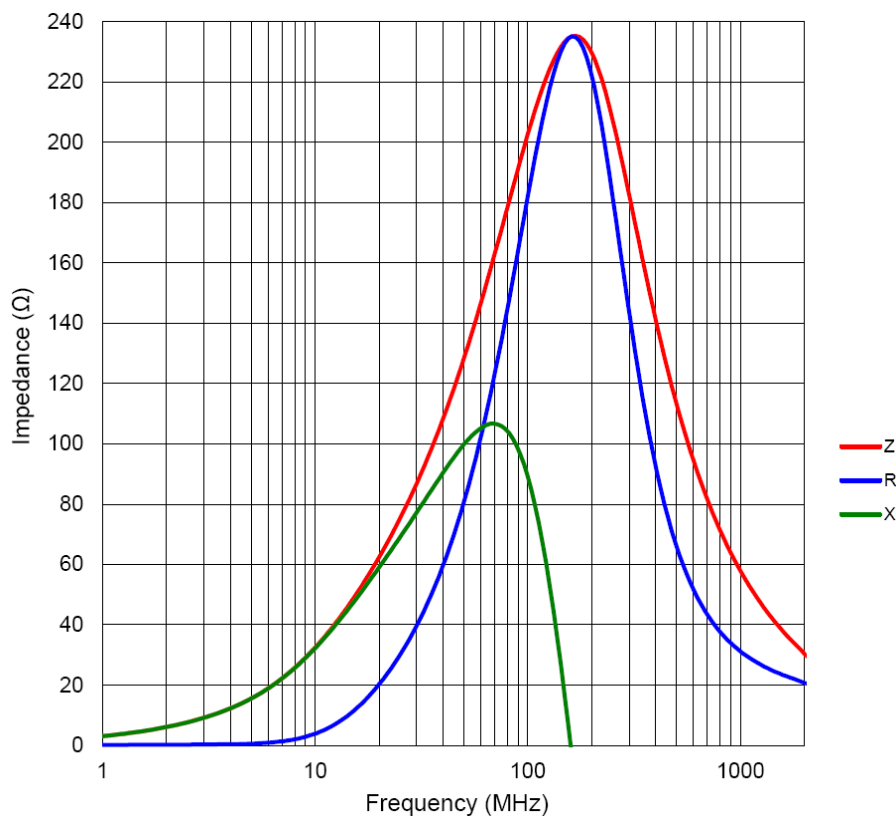

Reliability test

Item	Performance	Test condition
Operating temperature range	-55 °C to + 125 °C	
Storage temperature and umidity ranges	40 °C MAX., 70% RH MAX.	
Soldering heat resistance	The chip shall not be cracks. More than 75% of terminal electrode shall be covered with solder.	Preheat: 150 °C, 60 seconds Solder temperature : 270 ± 5 °C Flux: Rosin Dip time: 10 ± 1 seconds
Solderability	More than 90% of the terminal electrode shall be covered with new solder.	Preheat: 150 °C, 60 seconds Solder temperature: 245 ± 5 °C Flux: Rosin Dip time: 4 ± 1 seconds

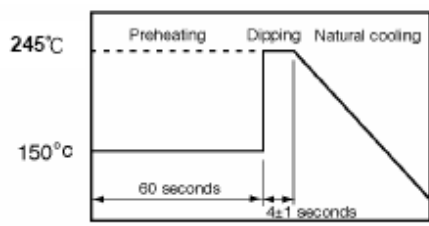
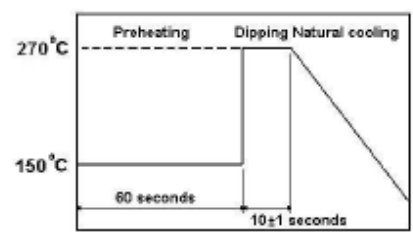

Recommended Soldering Conditions

(REFLOW TEMPERATURE PROFILE) **Lead-Free**

A	$260 \pm 5^{\circ}\text{C}$
B	$230 \pm 5^{\circ}\text{C}$
C	$30 \pm 10 \text{ sec}$
D	150°C
E	180°C
F	$90 \pm 30 \text{ sec}$

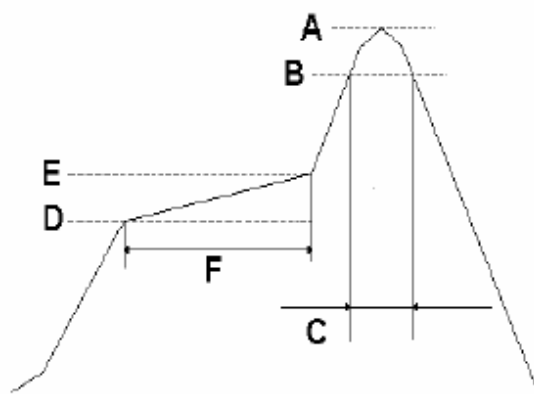

Reliability test

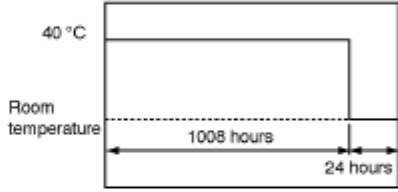
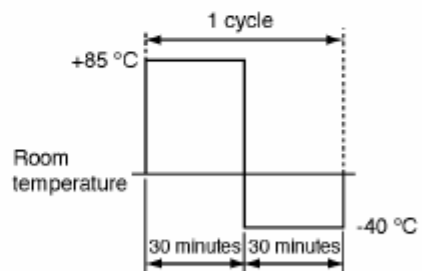
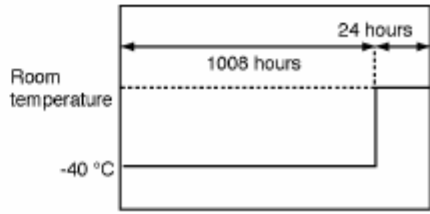
Item	Performance	Test condition
High temperature resistance	Appearance: Ferrite shall not be damaged. Impedance: Within±20% of the initial value.	Temperature: 85±2°C Testing time: 1008±12 hours Measurement: After placing for 24 hours min. 
Humidity resistance	Appearance: Ferrite shall not be damaged. Impedance: Within±20% of the initial value	Humidity: 90 to 95% RH Temperature: 40±2°C Testing time: 1008±12 hours Measurement: After placing for 24 hours min. 
Thermal Shock	Appearance: Cracking, chipping or any other defects harmful to the characteristics shall not be allowed. Impedance: Within±20% of the initial value	Temperature: -40°C, +85°C, kept stabilized for 30 minutes each Cycle: 100 cycles Measurement: After placing for 24 hours min. 
Low temperature storage life test	Appearance: Cracking, chipping or any other defects harmful to the characteristics shall not be allowed. Impedance: Within±20% of the initial value.	Temperature: -40±2°C Testing time: 1008±12 hours Measurement: After placing for 24 hours min. 

■ Taping Dimensions(Unit:mm)

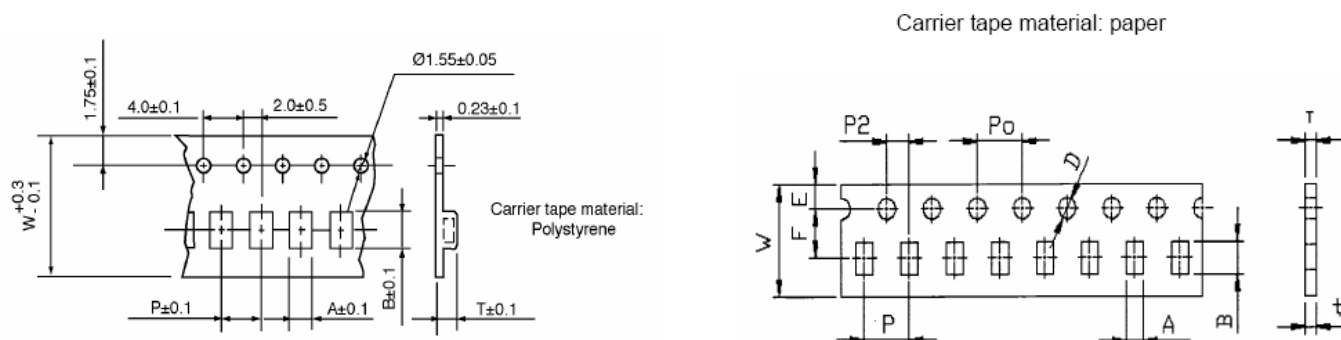

Material:Paper						
TYPE	A	B	W	P	T	CHIPS/REEL
100505	0.62	1.12	8	2	0.60	10000
160808	1.10	1.90	8	4	0.95	4000
201209	1.50	2.30	8	4	0.95	4000
Material:Polystyrene						
TYPE	A	B	W	P	T	CHIPS/REEL
160808	1.01	1.80	8	4	1.02	4000
201209	1.42	2.25	8	4	1.04	4000
201212	1.50	2.35	8	4	1.45	3000
321611	1.88	3.50	8	4	1.27	3000
322513	2.77	3.42	8	4	1.55	2000
451616	1.93	4.95	12	4	1.93	2000
453215	3.66	4.95	12	8	1.85	1000
YA3216M4	1.88	3.50	8	4	1.40	3000

Reel Dimensions(Unit:mm)

Material:Paper, Plastic

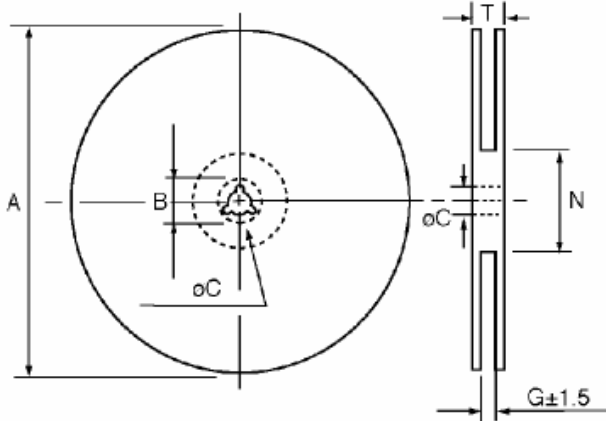

TYPE	8mm	12mm
A	178±2	178±2
B	21.0±0.8	21.0±0.8
C	13.0±0.8	13.0±0.8
G	10.0	14.0
N	75	75
T	12.5	16.5

Direction of rolling

