

MB24F

SURFACE MOUNT SHOTTKY BRIDGE



VOLTAGE: 40 Volts	CURRENT: 2.0 Amper	MBF	Marking & Schematic diagram
--------------------------	---------------------------	------------	--

FEATURES

- Reverse Voltage - 40V
- Forward Current - 2 A
- Schottky chip
- High Speed Switching

MECHANICAL DATA

- Case:** MBF
- Terminals:** Plated Leads Solderable per MIL-STD-202, Method 208
- Polarity:** As Marked on Case
- Mounting Position:** Any
- Lead Free:** For RoHS / Lead Free Version
- Weight:** App. 0.077 grams (0.0027 ounce)

TYPICAL APPLICATIONS

- For use in switch DC-DC inverters

PIN	DISCRIPTION
1	Output Cathode(-)
2	Output Anode(+)
3	Input Pin(-)
4	Input Pin(-)

Remark:

- NH=niuhang trademark
- FF=Product line code,According to actual changes
YWW=Data code,According to actual changes
- MB24F=Modle
- "- "+"=Polarity mark

Single phase, half wave, 60Hz, resistive or inductive load. For capacitive load, derate current by 20%

Maximum Ratings (Ratings at 25°C ambient temperature unless otherwise specified)

Parameter	Symbol	MB24F	Unit
Maximum Repetitive Peak Reverse Voltage	V_{RRM}	40	V
Maximum RMS Voltag	V_{RMS}	28	V
Maximum DC Blocking Voltage	V_{DC}	40	V
Maximum Average Forward Rectified Current @ TC=100°C (see fig.1)	$I_{F(AV)}$	2	A
Peak Forward Surge Current 8.3ms Single Half Sine-wave Superimposed On Rate Load (JEDEC Method)	I_{FSM}	50	A
Current Squared Time Per Diode(t<8.3ms)	I^2t	10.38	A ² sec

Electrical Characteristics (Ratings at 25°C ambient temperature unless otherwise specified)

Parameter	Test Conditions		Symbol	MB24F			Unit
				Min.	Typ.	Max.	
Maximum Forward Voltage Per Diode (Note 1)	Ta=25°C	IF= 2.0 A	V_{FM}	--	0.50	0.53	V
Maximum DC Reverse Current at Rated DC Blocking Voltage (Note 1)	Ta=25°C	VR= 40 V	I_{RRM}	--	--	50	uA
	Ta=125°C	VR= 40 V		--	--	10	mA
Typical Junction Capacitance Per Diode	4V,1MHz		C_J	--	220	--	pF

Thermal Characteristics (Ratings at 25°C ambient temperature unless otherwise specified)

Parameter	Symbol	MB24F	Unit
Operating Junction Temperature Range	T_J	-55 to 150	°C
Storage Temperature Range	T_{STD}	-55 to 150	
Typical thermal resistance (Note 2)	$R_{\theta JA}$	75.0	°C/W
	$R_{\theta JL}$	20.0	

- Notes:
- Pulse test: 300 μs pulse width, 1% duty cycle
 - Mounted on glass epoxy PC board with 4x1.5"x1.5" (3.81x3.81 cm) copper pad.

MB24F

SURFACE MOUNT SHOTTKY BRIDGE



RATING AND CHARACTERISTIC CURVES

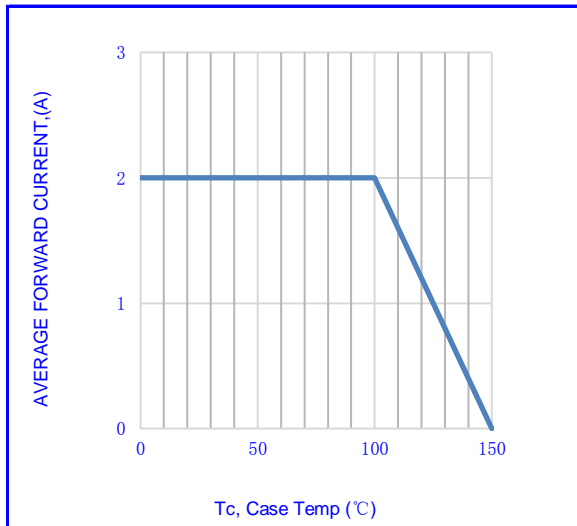

Fig.1-FORWARD CURRENT DERATING CURVE

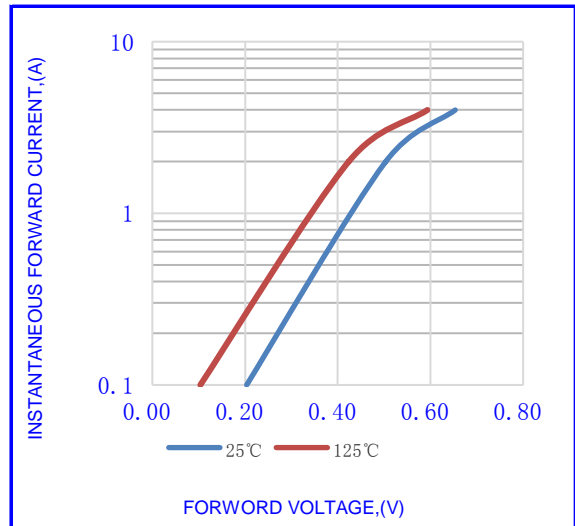

Fig.2- TYPICAL INSTANTANEOUS FORWARD

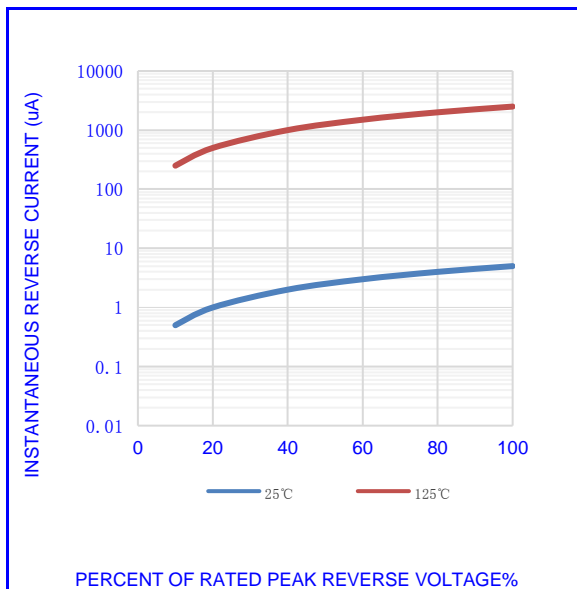

Fig.3- TYPICAL REVERSE CHARACTERISTICS

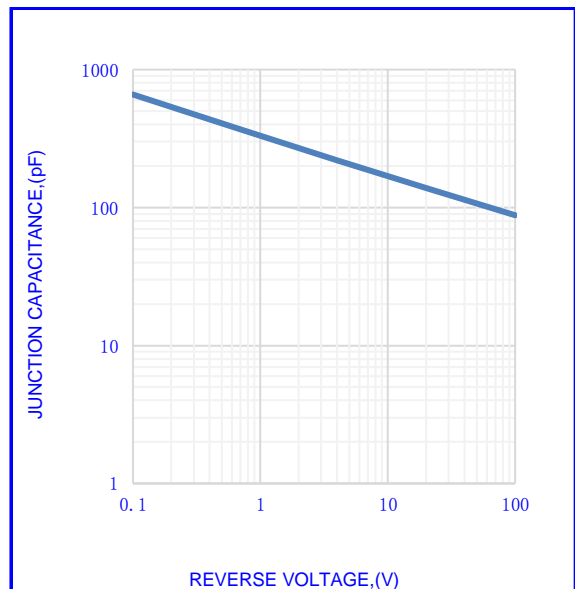

Fig.4- TYPICAL JUNCTION CAPACITANCE

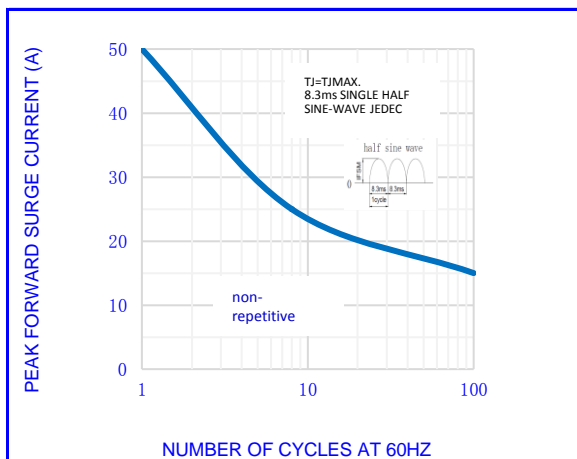

Fig.5-MAX. NON-REPETITIVE SURGE CURRENT

MB24F

SURFACE MOUNT SHOTTKY BRIDGE



OUTLINE DRAWINGS

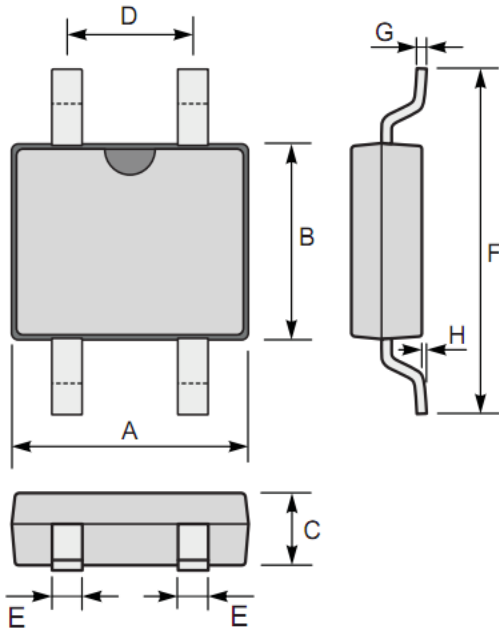

MBF

OUTLINE DIMENSIONS						
Dim.	Millimeters			Inches		
	Min.	Typ.	Max.	Min.	Typ.	Max.
A	4.500	-	4.900	0.177	-	0.193
B	3.600	-	4.000	0.142	-	0.157
C	1.200	-	1.600	0.047	-	0.063
D	2.200	-	2.800	0.087	-	0.110
E	0.450	-	1.050	0.018	-	0.041
F	6.600	-	7.000	0.260	-	0.276
G	0.150	-	0.350	0.006	-	0.014
H	-	-	0.200	-	-	0.008

RECOMMENDED LAYOUT DRAWINGS

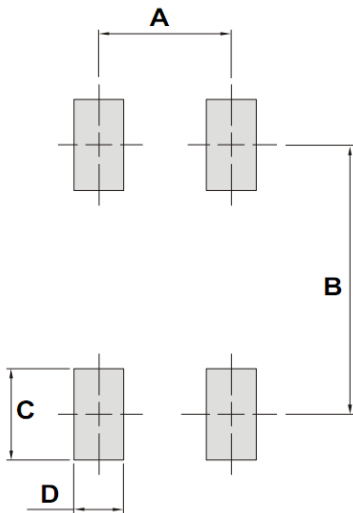

MBF

RECOMMENDED LAYOUT DIMENSIONS						
Dim.	Millimeters			Inches		
	Min.	Typ.	Max.	Min.	Typ.	Max.
A	-	2.400	-	-	0.0945	-
B	-	6.000	-	-	0.2362	-
C	-	1.840	-	-	0.0724	-
D	-	0.900	-	-	0.0354	-

PACKING INFORMATION

MBF

Package Method	Reel Size (mm)	Quantity (pcs/reel)	Inner Box Size LxWxH(mm)	Quantity (pcs/Inner Box)	Outer Carton Size LxWxH(mm)	Quantity (pcs/carton)
Tape Reel	Φ330	5000	340x340x40	10000	360x360x260	60000

MB24F

SURFACE MOUNT SHOTTKY BRIDGE



Recommended wave soldering condition

Product	Peak Temperature	Soldering Time
Pb-free devices	260 +0/-5 °C	5 +1/-1 seconds

Recommended temperature profile for IR reflow

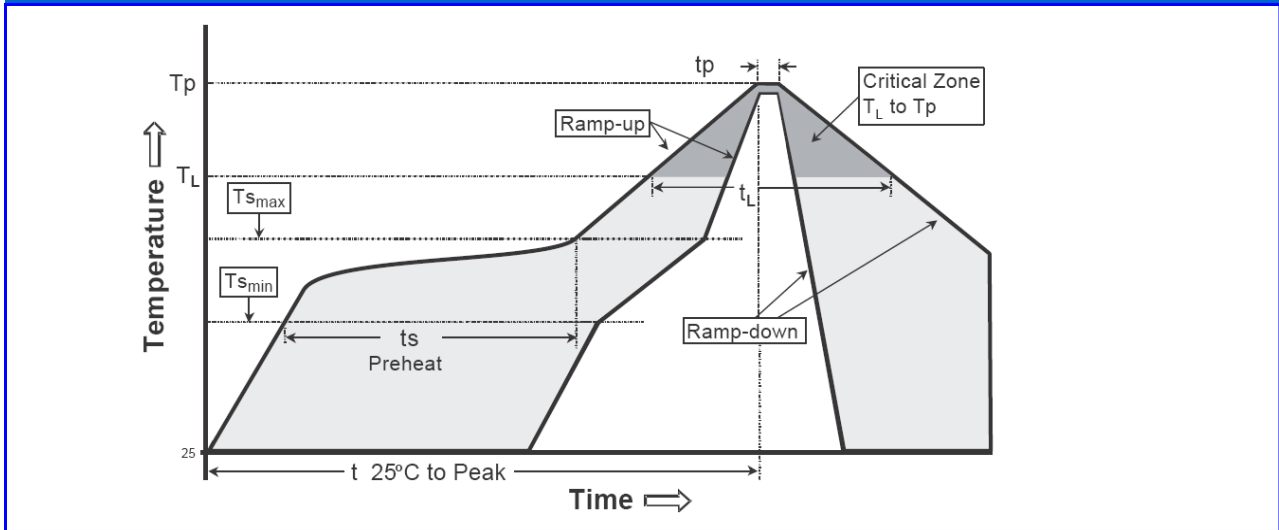

Profile feature	Sn-Pb eutectic Assembly	Pb-free Assembly
Average ramp-up rate (Tsmmax to Tp)	3°C/second max.	3°C/second max.
Preheat -Temperature Min(TS min) -Temperature Max(TS max) -Time(ts min to ts max)	100°C 150°C 60-120 seconds	150°C 200°C 60-180 seconds
Time maintained above: -Temperature (TL) - Time (tL)	183°C 60-150 seconds	217°C 60-150 seconds
Peak Temperature(TP)	240 +0/-5 °C	260 +0/-5 °C
Time within 5°C of actual peak temperature(tp)	10-30 seconds	20-40 seconds
Ramp down rate	6°C/second max.	6°C/second max.
Time 25 °C to peak temperature	6 minutes max.	8 minutes max.

Note : All temperatures refer to topside of the package, measured on the package body surface.

MB24F

SURFACE MOUNT SHOTTKY BRIDGE

**Disclaimer**

- Reproducing and modifying information of the document is prohibited without permission from niuhang Electronics co., LTD
- Niuhan Electronics co., LTD. reserves the rights to make changes of the content herein the document anytime without notification.
- Niuhan Electronics co., LTD. disclaims any and all liability arising out of the application or use of any product including damages incidentally and consequentially occurred.
- Niuhan Electronics co., LTD. does not assume any and all implied warranties, including warranties of fitness for particular purpose, non-infringement and merchantability.
- Applications shown on the herein document are examples of standard use and operation. Customers are responsible in comprehending the suitable use in particular applications. Niuhan Electronics co., LTD. makes no representation or warranty that such applications will be suitable for the specified use without further testing or modification.
- The products shown herein are not designed and authorized for equipments requiring high level of reliability or relating to human life and for any applications concerning life-saving or life-sustaining, such as medical instruments, transportation equipment, aerospace machinery et cetera. Customers using or selling these products for use in such applications do so at their own risk and agree to fully indemnify Niuhan Electronics co., LTD. for any damages resulting from such improper use or sale.
- When the appearance of the product and chip size does not change, in order to product the customer quality, change the internal structure and the production process Niuhan can not notify