

产品

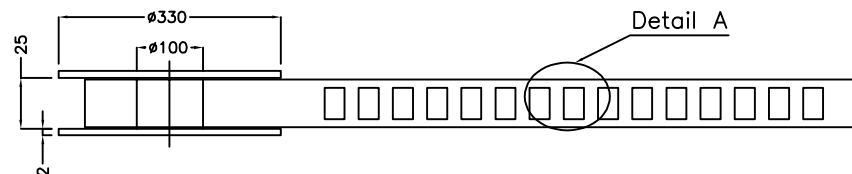

Detail A

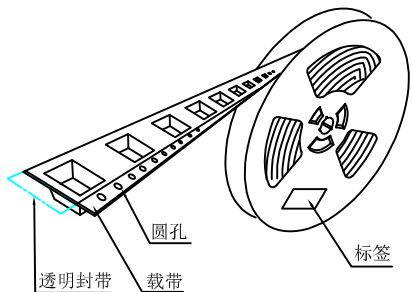
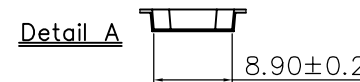
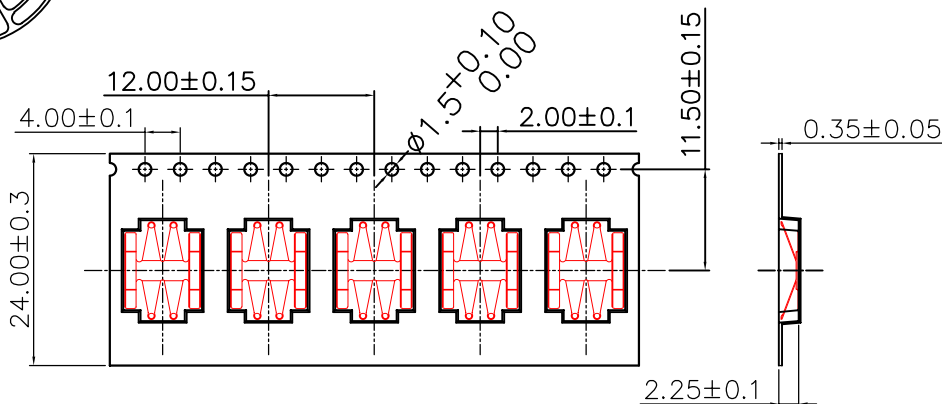
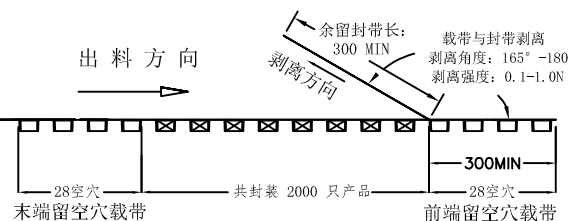
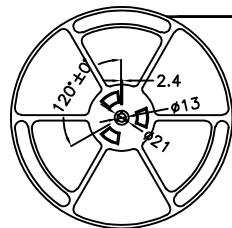
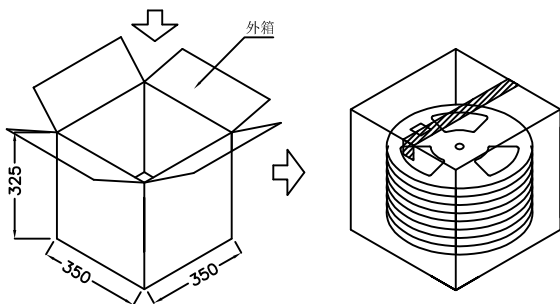
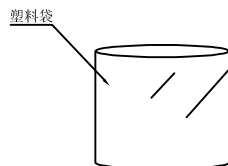
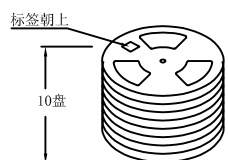

技术要求:

1. 圆孔十个孔距离累计允许公差为 $\pm 0.2\text{mm}$
2. 带长250mm内容许弯曲度1mm
3. 材料厚度以在载带边缘测量为准
4. 所有尺寸定义依循EIA-481-C系准则定义之
5. 材料:透明PS T=0.35 $\pm$ 0.05mm
6. 所有卷轮为灰蓝挖空旋转塑胶卷轮
7. 整模成型长度:24.672M,
8. 非指明公差范围为: $\pm 0.1\text{mm}$ ;超过250mm不计算累计误差
9. 型腔外形凡未标明处倒角R为0.2-0.3;拔模斜度未标注的为3° 以下

包装信息:

- 1、每卷盘装产品 2000 只, 卷盘外侧贴相关标签;
- 2、每 10 卷盘放在一个塑料袋中;
- 3、每外箱装10盘, 产品总数: 20000 只;
- 4、外箱上下用胶纸封成“工”字;

|  |                                   |                                    |              |                     |            |
|--|-----------------------------------|------------------------------------|--------------|---------------------|------------|
| UNLESS OTHERWISE SPECIFIED TOLERANCES                              |                                   | <b>MYOUNG 美阳</b> www.meiyangdz.com |              |                     |            |
| DECIMALS:<br>X : ±***<br>X.X : ±***<br>X.XX : ±***<br>X.XXX : ±*** | ANGLES:<br>X : ±***<br>X.X : ±*** | DSND                               | YangFeng     | DATE                | 2023-02-02 |
|  |                                   | CHKD                               | ZhouRuicai   | DATE                | 2023-02-02 |
|  |                                   | APVD                               | XueShun Yong | DATE                | 2023-02-02 |
| WEIGHT:  |                                   | SCALE:                             | 1:1          | SIZE:               | A4         |
| SHEET 1 OF 1   |                                   | VIEW:                              | ④            | REV.:               | A/0        |
|  |                                   | UNIT:                              | mm           | OBJECT:             | MY         |
|  |                                   | TITLE:                             |              | 八角电池弹片负极-127 SMT 卷装 |            |
|  |                                   | PART NO.:                          |              | MY-FJ-127-R         |            |
|  |                                   | DRAW NO.:MY-BD-0064                |              |                     |            |