

40V 250mA Ultralow-Quiescent-Current LDO

General Description

The GM7333 ultra-low quiescent current regulator features low dropout voltage and low current in the standby mode. With less than 1.5 μ A quiescent current at no load, the GM7333 is ideally suited for standby micro-control-unit systems, especially for always-on applications like E-meters, fire alarms, smoke detectors and other battery operated systems. The GM7333 retains all of the features that are common to low dropout regulators including a low dropout PMOS pass device, short circuit protection, and thermal shutdown.

The GM7333 has a 40-V maximum operating voltage limit, a -40°C to 125°C operating temperature range, and \pm 2% output voltage tolerance over the entire output current, input voltage, and temperature range. The GM7333 is available in a SOT893 through-hole and SOT235, surface mount packages.

Ordering Information

| Part Number | Package | Ordering Number |
|-------------|---------|-----------------|
| GM7333 | SOT893 | GM7333 |
| | SOT235 | GM7333K |

Features

- VIN Range up to 40V
- Output Voltage Tolerances of \pm 2% Over the Temperature Range
- Output Current of 250 mA
- Ultra Low Quiescent Current (IQ = 1.5 μ A)

- Dropout Voltage Typically 1200 mV at IO_{UT} = 250 mA
- Internal Thermal Overload Protection
- Internal Short-Circuit Current Limit
- Ceramic Capacitor Stable

Applications

- E-meters, Water Meters and Gas Meters
- Fire Alarm, Smoke Detector
- Appliances and White Goods

Pin Configuration

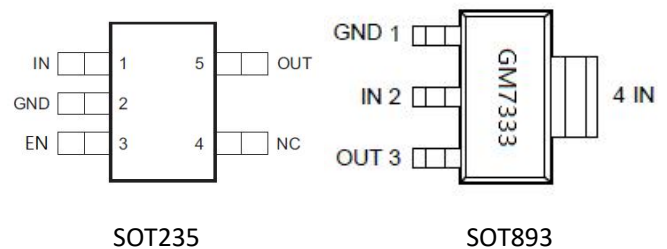

Typical Application Circuit

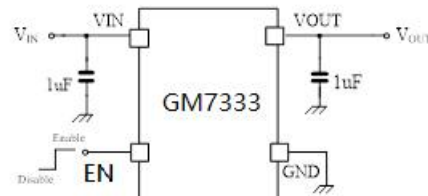
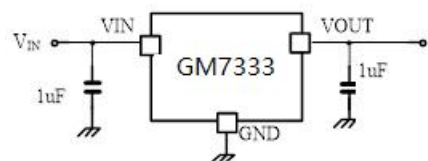

Pin Assignment

| Pin Name | Pin No. SOT235 | Pin No. SOT893 | Pin Function |
|----------|----------------|----------------|--------------------|
| VOUT | 5 | 3 | Output Voltage Pin |
| GND | 2 | 1 | Ground |
| VIN | 1 | 2,4 | Input Voltage pin. |
| EN | 3 | -- | Enable |

Function Block Diagram

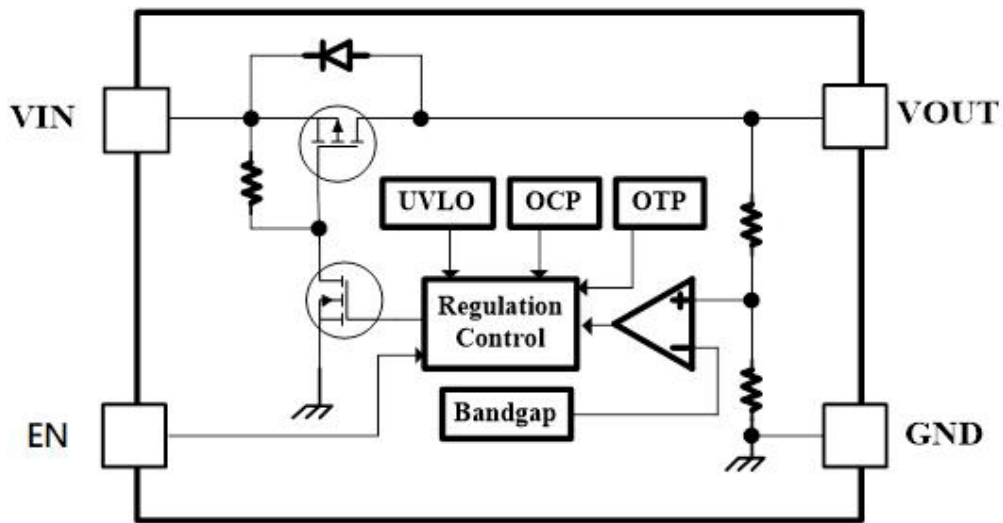

Absolute Maximum Ratings (Note1)

- V_{IN} ----- -0.3V to +45V
- Junction Temperature----- 125°C
- Lead Temperature (Soldering, 10 sec.)----- 300°C
- Storage Temperature ----- -65°C to 150°C

Recommended Operating Conditions

- Input Voltage, V_{IN} ----- +2.7V to +40V
- Junction Temperature ----- -40°C to 125°C

Electrical Characteristics

$V_{IN}=V_{OUT} + 1V$, $I_{OUT}=1mA$, $C_{IN}=C_{OUT}=2.2\mu F$, $T_J=25^\circ C$, unless otherwise specified

| Parameter | Symbol | Test Conditions | Min | Typ | Max | Units |
|------------------------------|-------------------|------------------------------|-----|------|-----|------------|
| Output Voltage | V_{OUT} | | -2% | 3.3 | 2% | V |
| Line Regulation | ΔV_{LINE} | $V_{IN}=V_{OUT} + 1V$ to 40V | | 2 | 12 | mV |
| Load Regulation | ΔV_{LOAD} | $I_{OUT}= 1mA$ to 100mA | | 10 | 20 | mV |
| | | $I_{OUT}= 1mA$ to 250mA | | 20 | 30 | |
| Dropout Voltage | V_{DROP} | $I_{OUT}=50mA$ | | 200 | | mV |
| | | $I_{OUT}=100mA$ | | 400 | | mV |
| | | $I_{OUT}=180mA$ | | 700 | | mV |
| | | $I_{OUT}=250mA$ | | 1200 | | mV |
| Quiescent Current | I_Q | $T_J= 25^\circ C$ | | 1.5 | 4.0 | μA |
| Output Current | I_{OUT} | | 0 | | 250 | mA |
| Current Limit | I_{CL} | | 270 | 340 | | mA |
| Enable high level | V_{ENHI} | | 0.9 | | | V |
| Enable low level | V_{ENLO} | | | | 0.4 | V |
| Enable pin pull high current | I_{EN} | | | 0.3 | | μA |
| Thermal Shutdown | T_{SD} | | | 140 | | $^\circ C$ |
| Thermal Shutdown Hysteresis | T_{HY} | | | 20 | | $^\circ C$ |

Typical Characteristics

$V_{IN}=V_{OUT} + 1V$, $I_{OUT}=1mA$, $V_{OUT}=3.3V$, $C_{IN}=C_{OUT}=1\mu F$, $T_J=25^\circ C$, unless otherwise specified

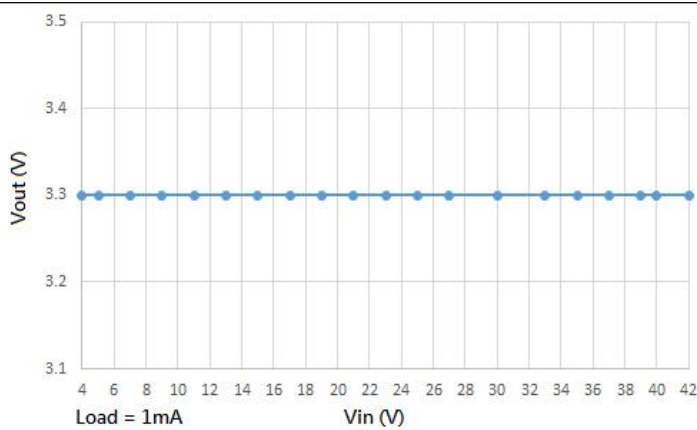

Fig 1 Vout vs Vin

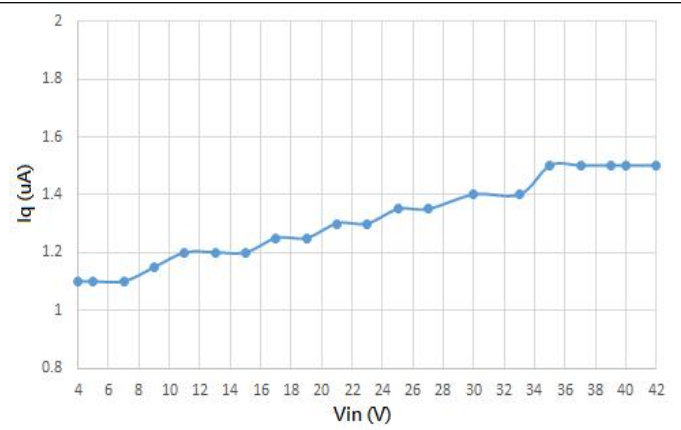

Fig 2 Iq vs Vin

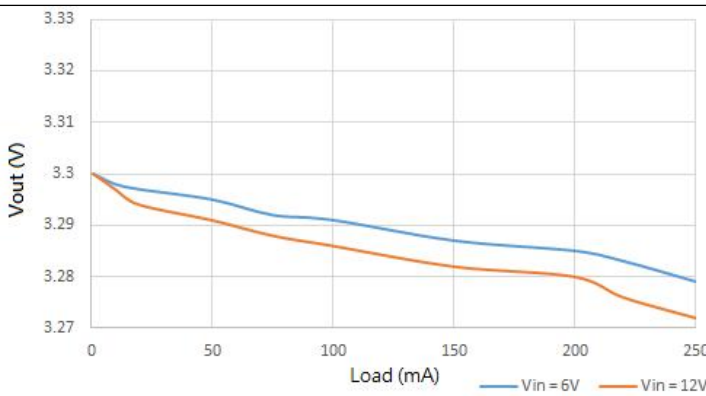

Fig 3 Vout vs Load

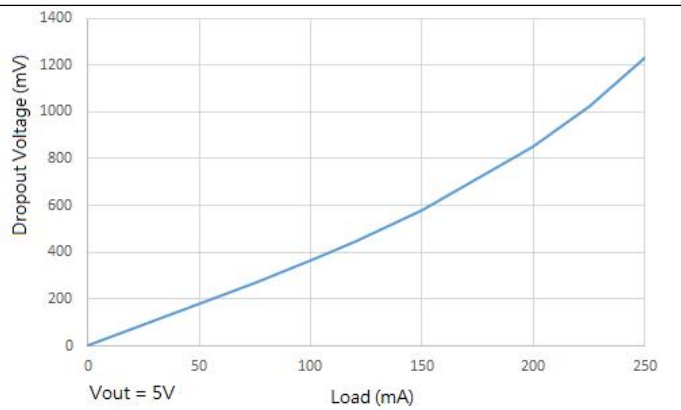

Fig 4 Dropout vs Load

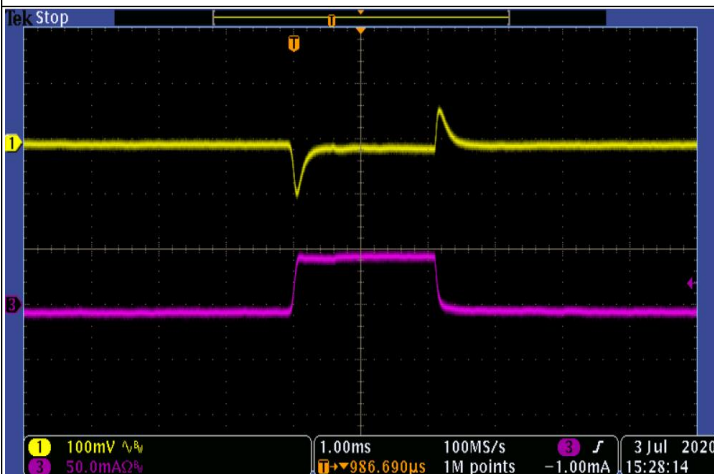

Fig 5 Vout Load Transient (0 to 50mA)

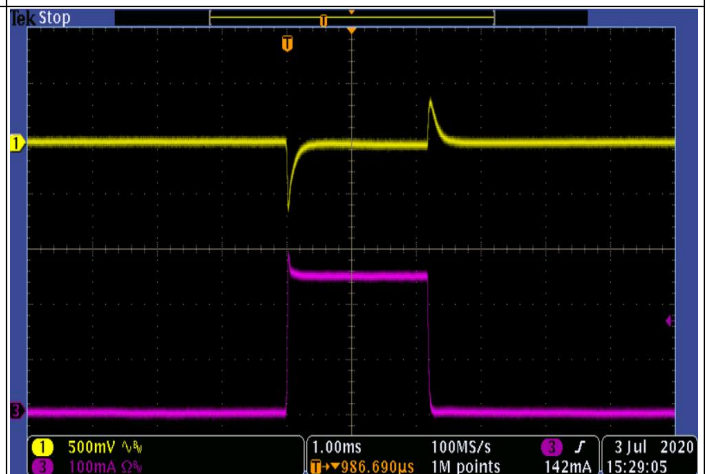

Fig 6 Vout Load Transient (1 to 250mA)

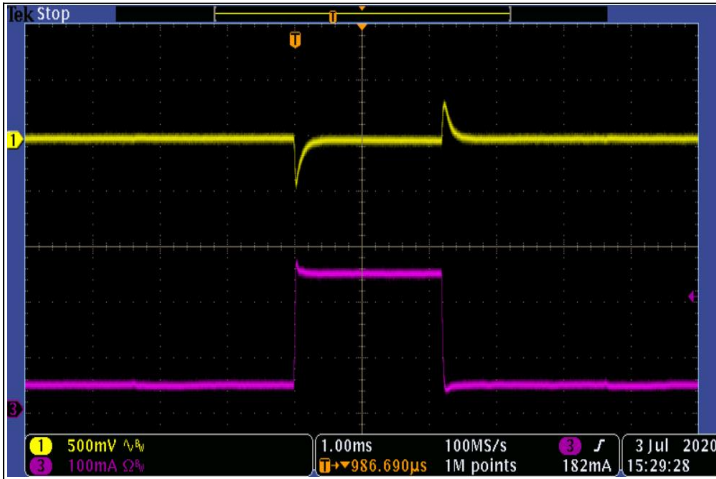

Fig 7 Vout Load Transient (50 to 250mA)

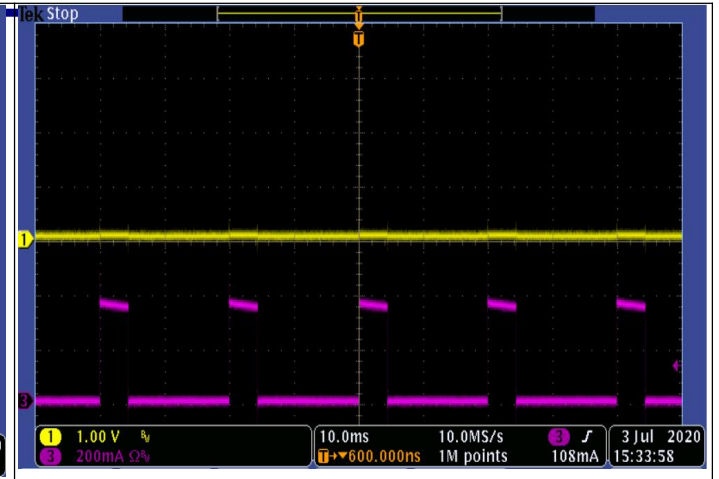

Fig 8 Vout Short to GND

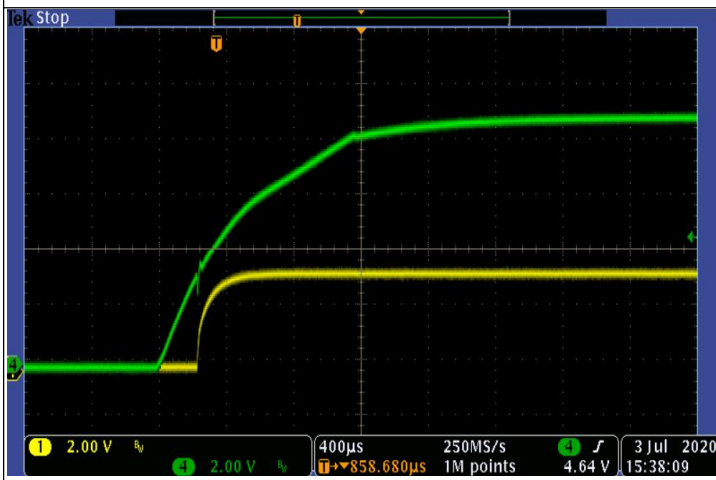
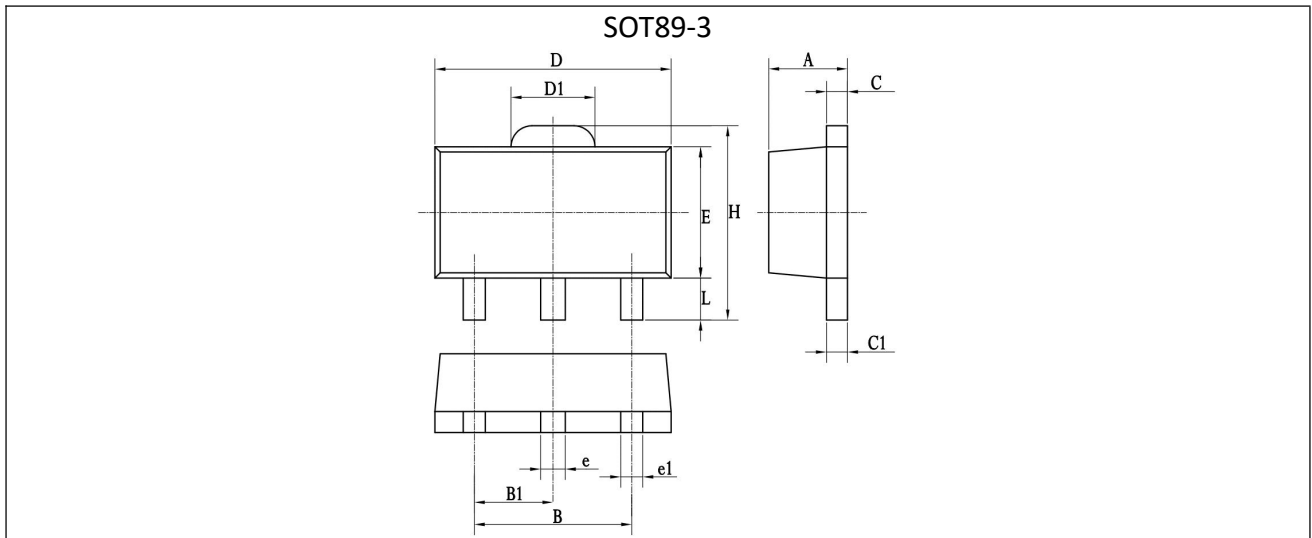
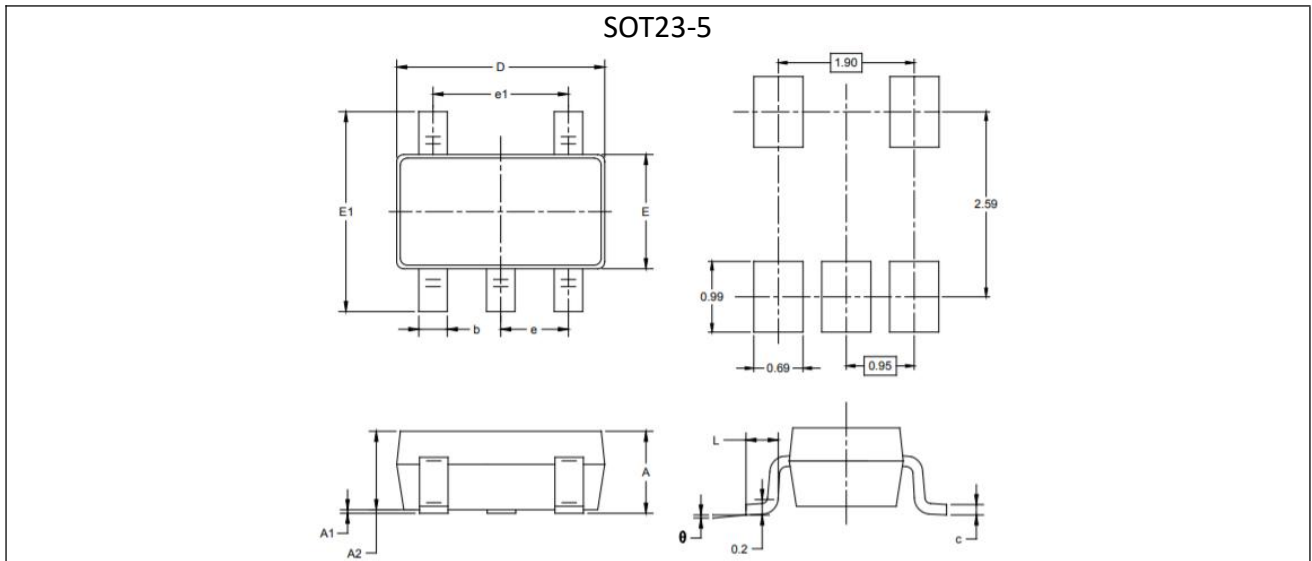

Fig 9 Vin Start up

Package Information



| 符号 | 毫米 | | | 英寸 | | |
|----|------|------|------|-----|-----|-----|
| | 最小值 | 典型值 | 最大值 | 最小值 | 典型值 | 最大值 |
| A | 1.4 | 1.5 | 1.6 | - | - | - |
| B | 2.8 | 3 | 3.2 | - | - | - |
| B1 | 1.4 | 1.5 | 1.6 | - | - | - |
| C | 0.3 | 0.4 | 0.5 | - | - | - |
| C1 | 0.3 | 0.4 | 0.5 | - | - | - |
| D | 4.4 | 4.5 | 4.6 | - | - | - |
| D1 | 1.4 | 1.6 | 1.8 | - | - | - |
| E | 2.4 | 2.5 | 2.6 | - | - | - |
| e | 0.37 | 0.47 | 0.57 | - | - | - |
| e1 | 0.22 | 0.42 | 0.62 | - | - | - |
| H | - | - | 4.25 | - | - | - |
| L | 0.8 | - | - | - | - | - |



| 符号 | 毫米 | | | 英寸 | | |
|----|------|------|------|-----|-----|-----|
| | 最小值 | 典型值 | 最大值 | 最小值 | 典型值 | 最大值 |
| A | 1.05 | 1.15 | 1.25 | - | - | - |
| A1 | 0.0 | 0.05 | 0.1 | - | - | - |
| A2 | 1.05 | 1.1 | 1.15 | - | - | - |
| b | 0.3 | 0.4 | 0.5 | - | - | - |
| c | 0.1 | 0.15 | 0.2 | - | - | - |
| D | 2.82 | 2.92 | 3.02 | - | - | - |
| E | 1.5 | 1.6 | 1.7 | - | - | - |
| E1 | 2.65 | 2.8 | 2.95 | - | - | - |
| e | | 0.95 | | - | - | - |
| e1 | | 1.9 | | - | - | - |
| L | 0.3 | - | 0.6 | - | - | - |
| θ | 0° | - | 8° | - | - | - |