

A		B		C		D		E	
1		2		3		4		5	
版本		更新图框、标注		变更内容		签名		日期	
A1								2021-09-17	

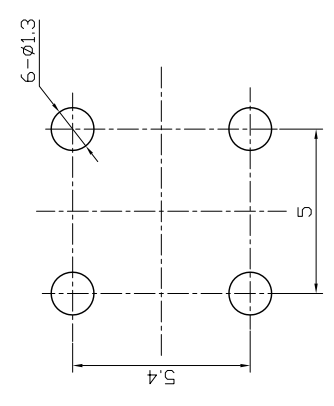

安装尺寸图

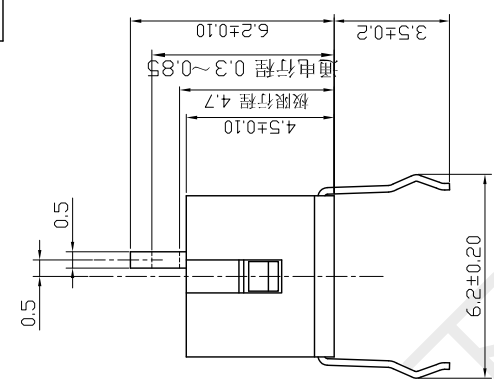
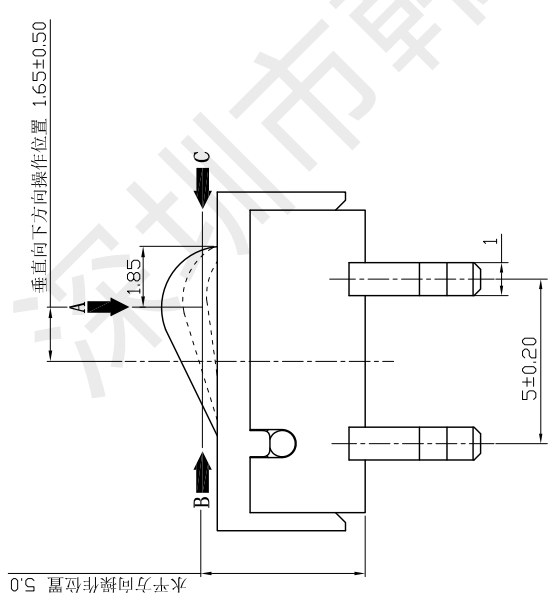
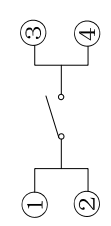
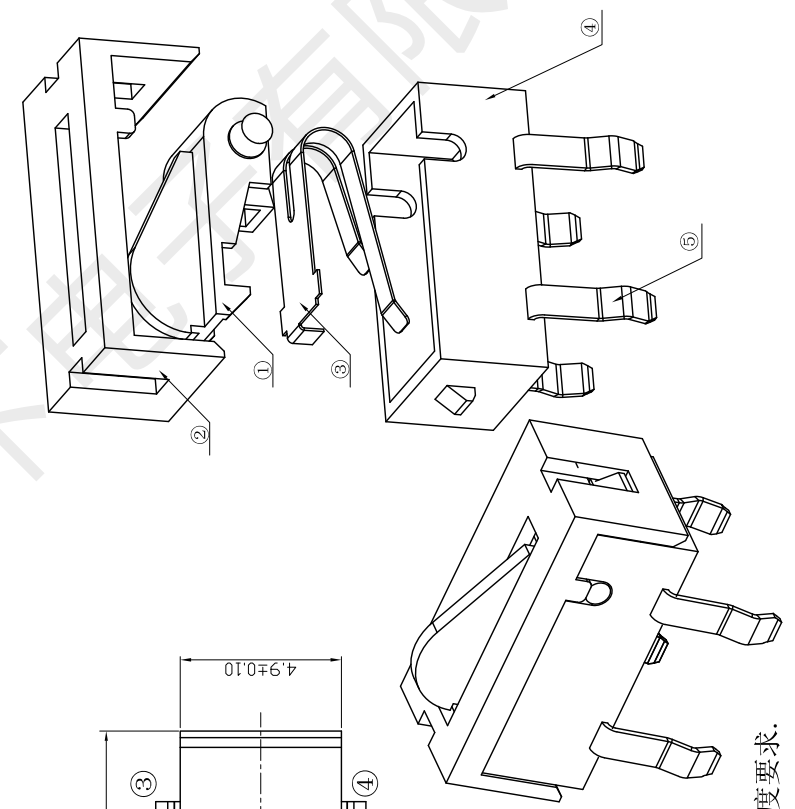
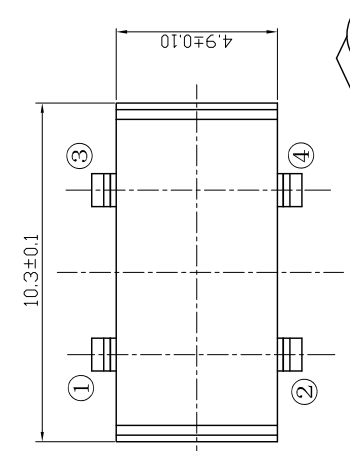

电路原理图

技术要求

- 1、额定电压 :16V (DC)
- 2、额定电流 :0.5A
- 3、开关绝缘电阻: ≥50MΩ.
- 3、开关接触电阻: ≤200mΩ.
- 4、开关动作力 :30g±20g
- 5、开关的寿命要求 ≥20000次循环。
- 6、未注尺寸公差按GB/T1804-m级精度要求。

序号	零件名称	数量	材质、规格	颜色、镀层	备注
⑥	端子	4	黄铜 t=0.20mm	镀银	
⑤	底座	1	PA46	黑色	
④	弹片	1	磷铜 t=0.08mm	镀银	
③	盖子	1	PA46	黑色	
②	按柄	1	POM	白色	

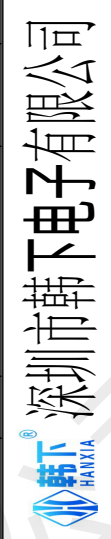

限位开关

HX KFC-V-105-8S

设计	黄彬	日期	2021-9-17
审核	张伟	日期	2021-9-17
批准	罗小春	日期	2021-9-17
版本	A1	单位	mm
比例	1:1		



深圳市韩下电子有限公司

Shenzhen Hanxia Electronic Co., Ltd  
Tel: 0755-33819206 Fax: 0755-27597491

## 承 认 书

### SPECIFICATION FOR APPROVAL

客 户 Customer:

\_\_\_\_\_

产品名称 Project:

限位开关

\_\_\_\_\_

规格型号 Part No:

HX KFC-V-105-8S

\_\_\_\_\_

#### 贵公司承认印 Approval signatures

料 号/Part No.	签 章/Signatures

日期 Date:

拟制/Drawn	黄彬	
审核/Check	张伟	
批准/Approved	罗小春	



## 规格书 SPECIFICATION

### 1. 一般特性 General Characteristics

- 1.1 额定值(Rating Value): DC 16V 50mA
- 1.2 工作温度(Work Temperature Range):  $-30^{\circ}\text{C} \sim 85^{\circ}\text{C}$
- 1.3 存储温度(Store Temperature Range):  $-20^{\circ}\text{C} \sim 80^{\circ}\text{C}$
- 1.4 正常测试条件(未有特殊说明量测在以下条件进行):

General test condition (Tests and measurements shall be made under the following standard conditions unless otherwise specified):

正常温度:  $5^{\circ}\text{C} \sim 35^{\circ}\text{C}$       相对湿度: 45%~85% RH      气压: 8,600~10,600 帕  
Temperature:  $5^{\circ}\text{C} \sim 35^{\circ}\text{C}$       Relative humidity: 45%~85%      Air pressure: 8,600~10,600 pa

### 2. 产品外观及尺寸要求 Appearance & Dimension Requirement

- 2.1 产品外形结构紧凑,无配合不良。  
The structure of product is compact, and assembly of parts has no badness.
- 2.2 产品塑胶部件无严重缩水、披锋、欠注、斑点、破损或变形现象。  
The plastic parts of product have no serious defects such as very serious shrink, scarcity, fleck, disrepair, transmutation, etc.
- 2.3 产品引脚和外壳无严重氧化、脏污、变形、毛刺或电镀不良。  
Lead feet and shell have no serious defects such as oxidation, smudge, disrepair, burr, defects on plating.
- 2.4 开关操作顺畅,节奏感强,无明显卡塞现象。  
Operating switch is unhindered, rhythmmed, and there is not palpable clag.
- 2.5 产品结构及尺寸参见产品规格图纸。  
Construction and dimensions: Refer to individual product drawing.

### 3. 电气特性 Electronic Characteristics

No.	项目 Item	测试方法 Test Method	测试设备 Equipment	特性要求 Requirements
3.1	接触电阻 Contact Resistance	在低电流 ( $\leq 100\text{mA}$ ) 条件下测试。 Measured at low current (100mA or less).	低电阻测试仪 Low Resistance Meter	200m $\Omega$ MAX
3.2	绝缘阻抗 Insulation Resistance	测试相邻引脚之间, 引脚与外壳之间的绝缘阻抗。 Measurement shall be made between adjacent terminals, between terminal and shell.	绝缘测试机 Insulation Resistance Tester	50M $\Omega$ MIN
3.3	耐压测试 Dielectric Withstand Voltage	输入一定电压 (50~60Hz, 电压值 AC 250V) 1 分钟, 漏电流为 2mA, 测试邻近端子间。 Apply certain voltage (50~60Hz, AC 250V) for 1 minute between adjacent contacts of the connector with 2mA leakage sensitivity.	耐压测试机 Puncture Tester	没有绝缘破坏。 电弧等异常。 No arcing, break down and damaging insulation.

## 4. 机械特性 Mechanical Characteristics

No.	项目 Item	测试方法 Test Method	测试设备 Equipment	特性要求 Requirements
4.1	操作力 Operation Force	<p>逐渐施力操作开关按键，测量开关到达全部工作行程时所需的最大操作力度。</p> <p>Operate the keystroke of the switch and then increase press strength gradually, Measured maximum operation force while the travel of the switch is full.</p>	测力计 Force Gauge	30±20gf

## 5. 可靠性测试 Reliability trial

No.	项目 Item	测试方法 Test Method	测试设备 Equipment	特性要求 Requirements
5.1	可焊性试验 Solder ability Test	<p>端子顶部被浸入焊锡炉中，温度为 260±5℃，时间 5±1 秒。</p> <p>The top of the terminals shall be dipped in the solder bath at 260±5℃ for 5±1 seconds.</p>	控温锡炉 Solder Stove	<p>引脚至少 95%上锡。</p> <p>Ninety-five percent of terminals shall be dipped.</p>
5.2	寿命试验 Operation Life	<p>开关在寿命试验设备上以约 90 次 / 分的速度连续被操作，具体次数见规格图示。</p> <p>Switch shall be operated continuously at about 90 cycles /min without load.</p>	寿命试验机 Life Tester	<p>寿命:20000 次</p> <p>实验后:</p> <p>绝缘电阻: 10MΩ Min</p> <p>操作力: 变化在±50%内开关外观及结构无损坏。</p> <p>Life test:20000 cycles</p> <p>After test, Insulation resistance:10MΩ Min</p> <p>Operating force: Change should be within ±50% of specified value.</p> <p>No abnormalities shall be recognized in appearance and construction.</p>
5.3	耐焊接热 Resistance to Soldering heat	<p>端子焊接部分浸入焊炉，焊炉温度 260± 5℃，焊接时间 5±1 秒。(焊接时不可于端子施加外力)。</p> <p>Terminals shall be dipped in the solder bath at 260±5℃ for 5±1 seconds without additional force for terminals.</p>	控温锡炉 Solder Stove	<p>本体无变形，能满足于机械、电气性能。</p> <p>Appearance should be not damaged, electrical and mechanical characteristics shall be satisfied.</p>

## 5. 可靠性测试 Reliability trial

No.	项 目 Item	测试方法 Test Method	测试设备 Equipment	特 性 要 求 Requirements
5.4	耐高温测试 Resistance to Heat Test	放置在温度 $80\pm 2^{\circ}\text{C}$ 环境中 96 小时后，再置于正常条件下 1 小时后测定。 The switch shall be stored at a temperature of $80\pm 2^{\circ}\text{C}$ for 96 hours, Measurements shall be made after it be subjected to the standard conditions for 1 hour.	高低温试验机 High & Low Temperature Tester	外观，机械及电气性能均符合要求。 Appearance, electrical and mechanical characteristics shall be satisfied.
5.5	耐低温测试 Resistance to Cold Test	放置在温度 $-20\pm 2^{\circ}\text{C}$ 环境中 96 小时后，再置于正常条件下 1 小时后测定。 The switch shall be stored at a temperature of $-20\pm 2^{\circ}\text{C}$ for 96 hours, Measurements shall be made after it be subjected to the standard conditions for 1 hour.	高低温试验机 High & Low Temperature Tester	外观，机械及电气性能均符合要求。 Appearance, electrical and mechanical characteristics shall be satisfied.
5.6	耐湿性测试 Resistance to Humidity Test	放置于温度 $40\pm 2^{\circ}\text{C}$ ，相对湿度为 90~96% 环境中 96 小时后，再置于正常条件下 1 小时后测定(注意要擦去水滴)。 The switch shall be stored at a temperature of $40\pm 2^{\circ}\text{C}$ , relative humidity 90~96% for 96 hours, Measurements shall be made after it be subjected to the standard conditions for 1 hour (Wipe out water drip).	恒温恒湿箱 Temperature & Humidity Tester Chamber	外观，机械及电气性能均符合要求。 Appearance, electrical and mechanical characteristics shall be satisfied.
5.7	盐雾实验 Salt Mist Test	试件在下述实验后测量： 1. 温度： $35\pm 5^{\circ}\text{C}$ 2. 盐溶液浓度： $5\pm 1\%$ (质量百分比)， 3. 试验时间：24 小时， 4. 试验后，将盐沉积物用水冲掉。 The switch shall be checked after following test: 1. Temperature: $35\pm 5^{\circ}\text{C}$ 2. Salt solution: $5\pm 1\%$ (Solids by mass) 3. Duration: 24 hours, 4. After immersing, salt deposit shall be removed by running water.	盐雾试验机 Salt Spray Tester	在金属件上没有严重腐蚀斑点。 No remarkable corrosion shall be recognized in metal parts.