

**3-TERMINAL 1.5A POSITIVE
ADJUSTABLE VOLTAGE
REGULATOR**

FEATURES

- *Output current up to 1.5A
- *Internal short circuit protection
- *Internal over temperature protection
- * Safe-Area compensation for output transistor
- *Output voltage adjustable from 1.3V to 37V

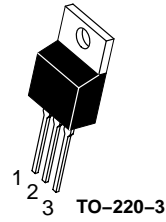

LM317BT

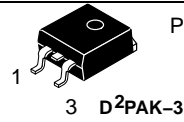

Pin 1. Input
2. Ground
3. Output

LM317KT
LM317D2TR

BLOCK DIAGRAM

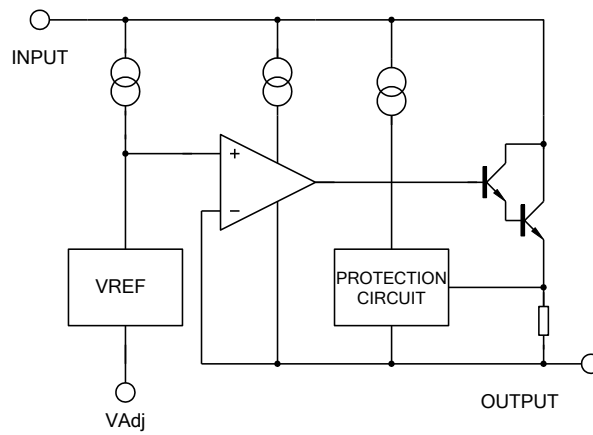

ABSOLUTE MAXIMUM RATINGS ($T_a=25^{\circ}\text{C}$, UNLESS OTHERWISE SPECIFIED)

PARAMETERS	SYMBOL	RATING	UNITS
Input – Output Voltage Difference	V_i-V_o	40	V
Lead Temperature	T_{LEAD}	260	$^{\circ}\text{C}$
Power Dissipation	P_d	Internal limited	—
Operating Temperature Range	T_{OPR}	-40 ~+125	$^{\circ}\text{C}$
Storage Temperature Range	T_{STG}	-65~+150	$^{\circ}\text{C}$

ELECTRICAL CHARACTERISTICS

 ($V_i-V_o=5\text{V}$, $0^{\circ}\text{C} < T_j < 125^{\circ}\text{C}$, $I_o=500\text{mA}$, $I_{\text{MAX}}=1.5\text{A}$, $P_{\text{MAX}}=20\text{W}$, unless otherwise specified)

Parameter	Symbol	Test conditions	Min	Typ	Max	Unit
Line Regulation	ΔV_o	$T_a=25^{\circ}\text{C}$, $3\text{V} \leq V_i-V_o \leq 40\text{V}$		0.01	0.04	%V
		$T_a=0-125^{\circ}\text{C}$, $3\text{V} \leq V_i-V_o \leq 40\text{V}$		0.02	0.07	
Load Regulation	ΔV_o	$T_a=25^{\circ}\text{C}$	$V_o \leq 5\text{V}$	18	25	mV
		$10\text{mA} \leq I_o \leq I_{\text{MAX}}$	$V_o \geq 5\text{V}$	0.4	0.5	%V _o
		$10\text{mA} \leq I_o \leq I_{\text{MAX}}$	$V_o \leq 5\text{V}$	40	70	mV
		$T_a=0-125^{\circ}\text{C}$	$V_o \geq 5\text{V}$	0.8	1.5	%V _o
Adjustable Pin current	I_{ADJ}			46	100	μA
Adjustable Pin Current Change	ΔI_{ADJ}	$2.5\text{V} \leq V_i-V_o \leq 40\text{V}$, $10\text{mA} \leq I_o \leq I_{\text{MAX}}$, $P_d \leq P_{\text{MAX}}$		0.3	5	μA
Reference Voltage	V_{REF}	$3\text{V} \leq V_i-V_o \leq 40\text{V}$, $10\text{mA} \leq I_o \leq I_{\text{MAX}}$, $P_d \leq P_{\text{MAX}}$	1.20	1.25	1.30	V
Temperature Stability	STT			0.7		%V _o
Minimum Load Current for regulation	$I_{\text{L(MIN)}}$	$V_i-V_o=40\text{V}$		3.5	10	mA
Maximum output Current	$I_{\text{O(MAX)}}$	$V_i-V_o \leq 15\text{V}$, $P_d \leq P_{\text{MAX}}$	1.5	2.2		A
		$V_i-V_o=40\text{V}$, $P_d \leq P_{\text{MAX}}$, $T_a=25^{\circ}\text{C}$	0.15	0.4		
RMS Noise v.s. %of V _{out}	eN	$T_a=25^{\circ}\text{C}$, $10\text{Hz} \leq f \leq 10\text{kHz}$		0.003	0.01	%V _o
Ripple Rejection	RR	$V_o=10\text{V}$, $f=120\text{Hz}$, $C_{\text{ADJ}}=0$		60		dB
		$V_o=10\text{V}$, $f=120\text{Hz}$, $C_{\text{ADJ}}=10\mu\text{F}$	66	75		
Long-term Stability, $T_j=T_{\text{HIGH}}$	ST	$T_a=25^{\circ}\text{C}$, 1000 hr		0.3	1	%

Note: Testing with low duty pulse should be used to avoid heating effect.

TYPICAL CHARACTERISTICS PERFORMANCE

Fig.1 Load Regulation vs temperature

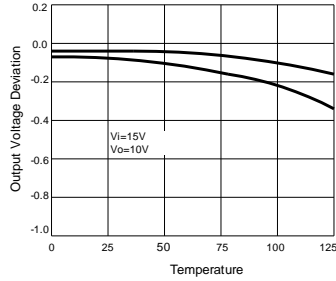

Fig.2 Adjustment Current vs Temperature

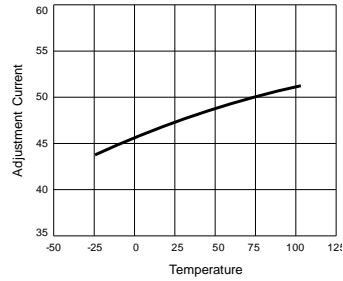

Fig.3 Dropout Voltage vs Input-Output Voltage Difference

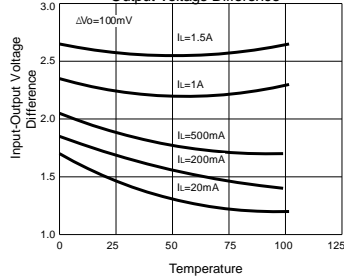
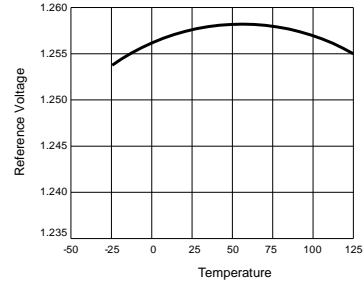

Fig.4 Reference Voltage vs Temperature



TYPICAL APPLICATION CIRCUITS

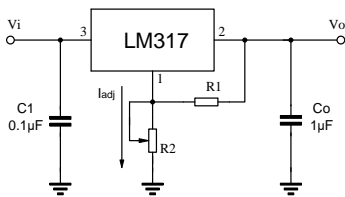

Fig.5 Programmable voltage regulator
 $V_o = 1.25V * (1 + R2/R1) + I_{adj} * R2$
 C1 is required when regulator is located an appreciated distance from power supply. Co is needed to improve transient response.

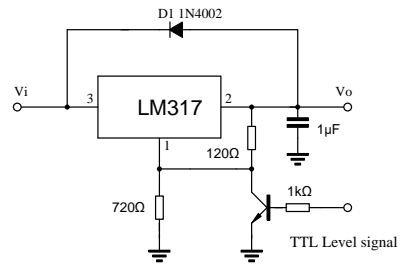

Fig.6 Regulator with On-off control

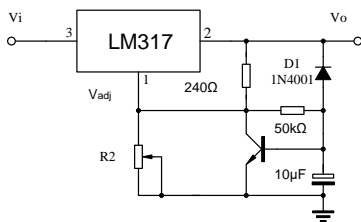
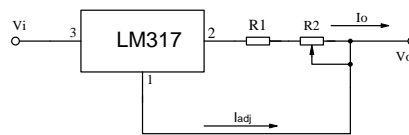

Fig.7 Soft start application



$$I_{omax} = \left(\frac{V_{ref}}{R1} \right) + I_{adj} = \frac{1.25V}{R1}$$

$$I_{omin} = \left(\frac{V_{ref}}{R1+R2} \right) + I_{adj} = \frac{1.25V}{R1+R2}$$

$$5mA < I_o < 100mA$$

Fig.8 Constant current application