

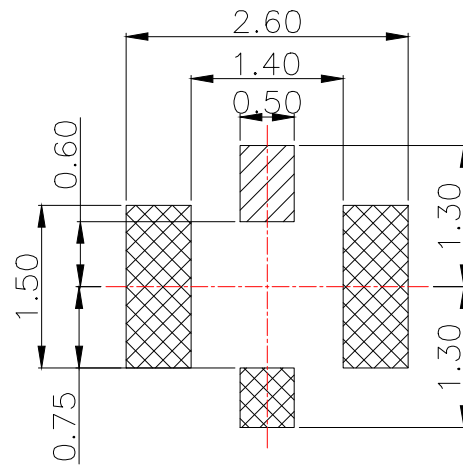

SECTION A-A

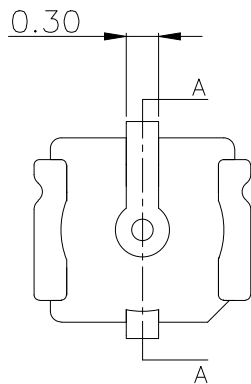

RECOMMENDED PCB LAYOUT
(TOLERANCE:±0.05)

 CENTER CONTACT
  GROUND CONTACT

NOTES :

1.0. RATING :

- 1.1. VOITAGE :60 VAC (R.M.S.)
- 1.2. NOMINAL CHARACTERISTIC IMPEDANCE: 50 Ohm
- 1.3. APPLICABLE FREQUENCY: DC ~ 6GHz
- 1.4. VSWR: 1.3 MAX. (DC~3GHz), 1.5 MAX. (3~6GHz)
- 1.5. TEMPERATURE :−40°C TO +85°C

- 2.0. ALL DIMENSIONS SHOULD BE CONTROLLED IN FAI:
- 3.0. MARKED  SHOULD BE CONTROLLED BY QIP.:

MANUFACTURE DWG		 东莞市讯普电子科技有限公司 DongGuan XunPu Electronics Co.,Ltd	
UNLESS OTHERWISE SPECIFIED TOLERANCES			TITLE: MICRO RF III RECEPTACLE SMT TYPE
			PAR IPEX-003
DECIMALS:	ANGLES:		DWN
X.X±0.20	:±3.0°		CHKD
X.XX±0.10	X.*±2.0°	APVD	
X.XXX±0.05	X.X*±1.0°	CUSTOMER COPY	SCALE:1:1 UNIT:MM
		SIZE:A4	SHEET:1F1
			REV:A

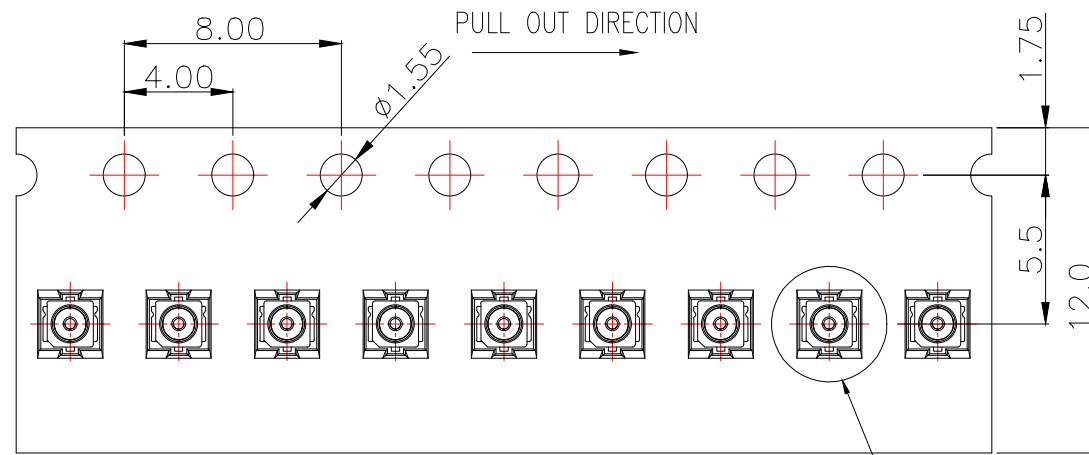

- NOTES:
- MATERIAL :
 - 1.1 EMBOSSED CARRIER: PET
 - 1.2 COVER TAPE: PET
 - 1.3 SHIPPING CARTON: CORRUGATED FIBER
 - DIMENSION :
 - 2.1 REEL: W=12.4
 - 2.2 SHIPPING CARTON: L=190, W=190, H=190
 - PEELING RESISTANCE: 10gf~130gf.
 - QUANTITY/WEIGHT :

PART NO.	PRIMARY PACKING	SECONDARY PACKING	NET WEIGHT	GROSS WEIGHT
IPEX-003	3000PCS/REEL	30000PCS/BOX	0.18KG/REEL	2.00KG/BOX

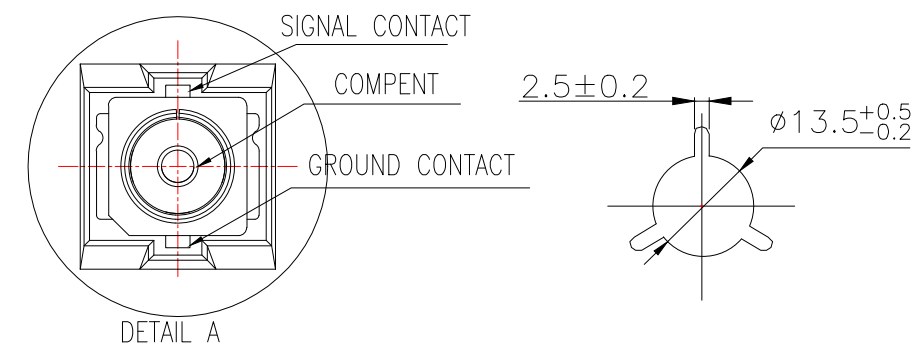
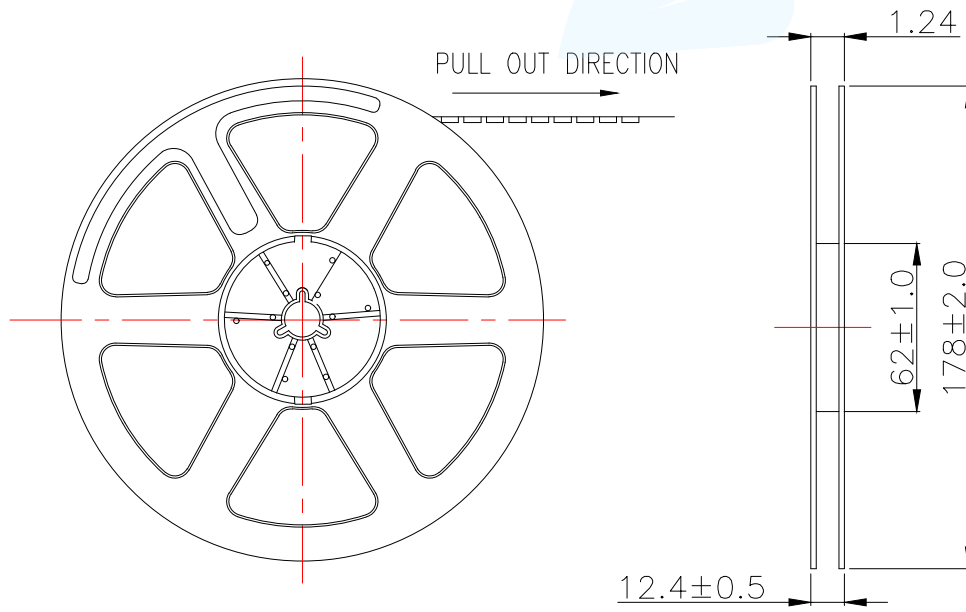
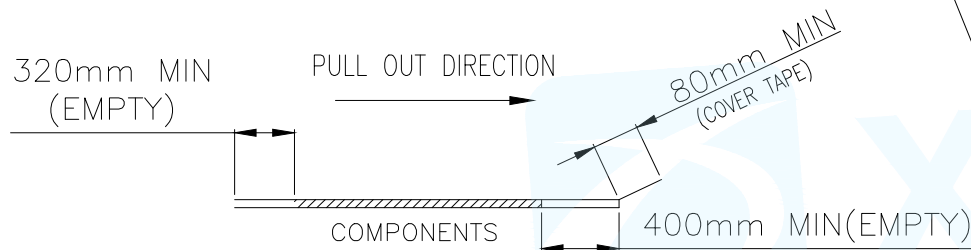

MANUFACTURE DWG		东莞市讯普电子科技有限公司 DongGuan XunPu Electronics Co.,Ltd	
UNLESS OTHERWISE SPECIFIED TOLERANCES			TITLE: MICRO RF III RECEPTACLE SMT TYPE
			PAR: IPEX-003
DECIMALS:	ANGLES:		DWN
X.X±0.20	°±3.0°		CHKD
X.XX±0.10	X.*±2.0°	APVD	
X.XXX±0.05	X.X*±1.0°	CUSTOMER COPY	SCALE:1:1 UNIT:MM
		SIZE:A4	UNIT:MM
		SHEET:1F1	REV:A

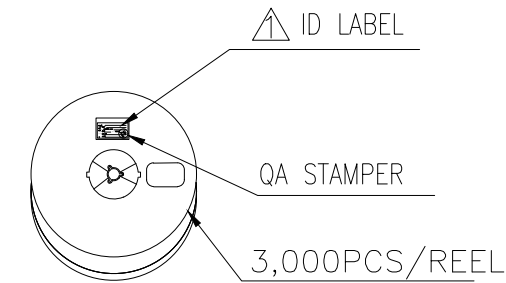

10 REELS/CARTON

品名 NAME: _____

料号 PART No: _____

客户料号 CUSTOMER PART No: _____

数量 Q'TY: _____ 重量 WEIGHT: _____

批次 LOT No: _____

日期 DATE: _____

ID LABEL

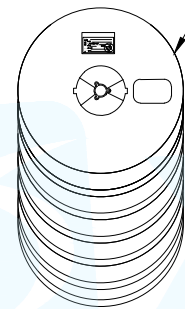
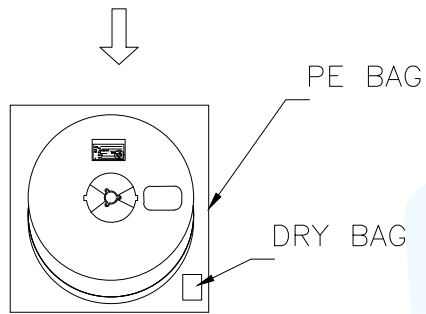

PAPER SHEET

ID LABEL

STICK TAPE

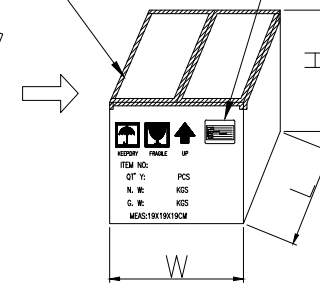
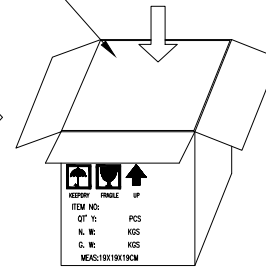
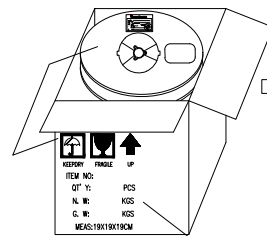

QT' Y: 30,000 PCS
 N. W: 1.76 KGS
 G. W: 2.0 KGS
 MEAS: 19X19X19CM

MANUFACTURE DWG		 东莞市讯普电子科技有限公司 DongGuan XunPu Electronics Co.,Ltd	
UNLESS OTHERWISE SPECIFIED TOLERANCES			TITLE: MICRO RF III RECEPTACLE SMT TYPE
DECIMALS:	ANGLES:		PAR IPEX-003
X.X±0.20	.°±3.0°		DWN
X.XX±0.10	X.°±2.0°		CHKD
X.XXX±0.05	X.X°±1.0°	APVD	SCALE 1:1 UNIT:MM
CUSTOMER COPY		SIZE:A4	SHEET:1F1 REV:A