



Features

- Low driver power requirements (TTL/CMOS Compatible)
- No moving parts
- High reliability
- Arc-Free with no snubbing circuits
- 3750Vrms Input/Output isolation

Applications

- Telecommunications (PC, Electronic notepad)
- Measuring and Testing equipment
- Industrial control
- Security equipments
- High speed inspection machine Arc-Free with no snubbing circuits



SMD-6



DIP-6

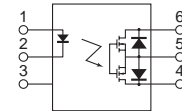

1. LED Anode
2. LED Cathode
4. Drain (MOS FET)
5. Source (MOS FET)
6. Drain (MOS FET)

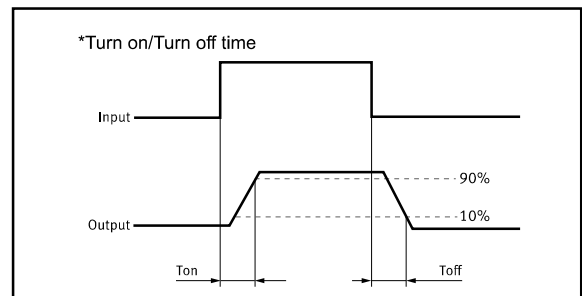

TYPES

Category	Output rating		Package	Part No.	Packing quantity
	Load voltage	Load current			
AC/DC	600V	80mA	DIP6	GAQV216E	50pcs/tube
			SMD6	GAQV216EH	1000pcs/reel

Absolute Maximum Ratings (Ambient Temperature: 25 °C)

Item		Symbol	Value	Units	Note
Input	Continuous LED Current	I _F	50	mA	
	Peak LED Current	I _{FP}	1000	mA	f=100Hz, duty=1%
	LED Reverse Voltage	V _R	5	V	
	Input Power Dissipation	P _{In}	75	mW	
Output	Load Voltage	V _L	600	V(AC peak or DC)	
	Load Current	I _L	80	mA	
	Peak Load Current	I _{Peak}	120	mA	100ms(1 pulse)
	Output Power Dissipation	P _{out}	450	mW	
Total Power Dissipation		P _T	500	mW	
I/O Breakdown Voltage		V _{I/O}	3750	V _{rms}	RH=60%, 1min
Operating Temperature		T _{opr}	-40 to +85	°C	
Storage Temperature		T _{stg}	-40 to +100	°C	
Pin Soldering Temperature		T _{sol}	260	°C	10 sec max.

Electrical Specifications (Ambient Temperature: 25 °C)

Item		Symbol	MIN.	TYP.	MAX.	Units	Conditions
Input	LED Forward Voltage	V _F		1.2	1.5	V	I _F =10mA
	Operation LED Current	I _{F on}		0.5	5.0	mA	
	Recovery LED Current	I _{F off}		0.35	0.5	mA	
	Recovery LED Voltage	V _{F off}	0.7			V	
Output	On-Resistance	R _{on}		35	70	Ω	I _F =5mA, I _L =100mA, Time to flow is within 1 sec.
	Off-State Leakage Current	I _{Leak}			1	uA	V _L =Rating
	Output Capacitance	C _{out}		100		pF	V _L =0, f=1MHz
Transmis sion	Turn-On Time	T _{on}		0.5	1.0	ms	I _F =5mA, I _L =100mA,
	Turn-Off Time	T _{off}		0.02	0.2	ms	
Coupled	I/O Isolation Resistance	R _{I/O}	10 ¹⁰			Ω	DC500V
	I/O Capacitance	C _{I/O}		0.8	1.5	pF	f=1MHz

Reference Data

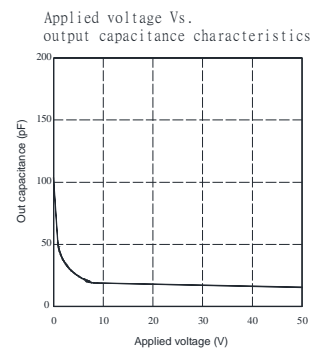
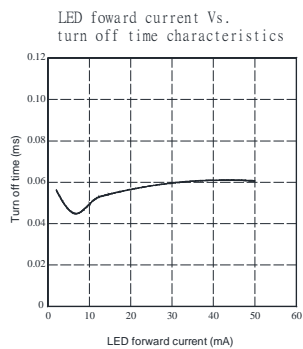
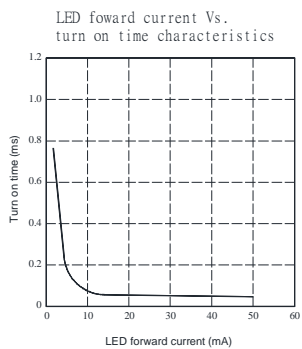
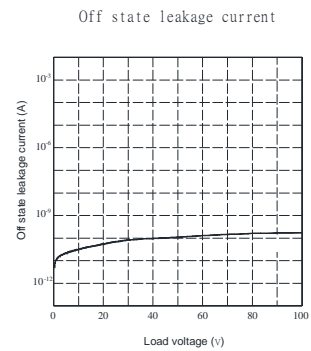
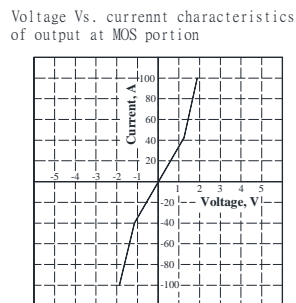
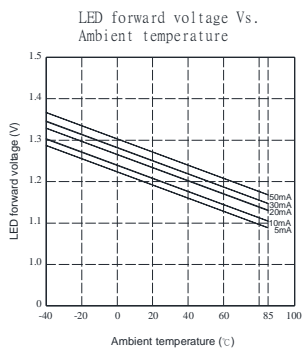
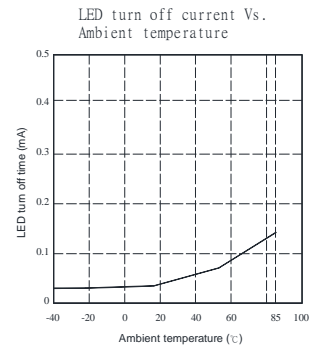
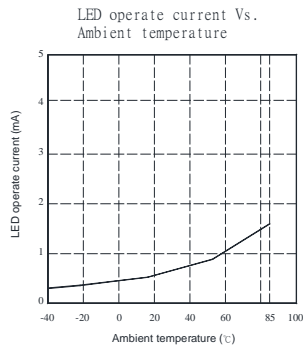
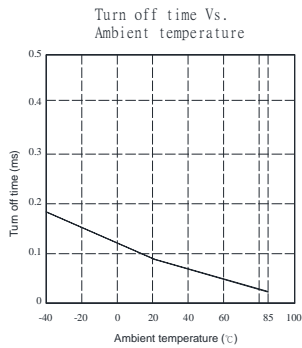
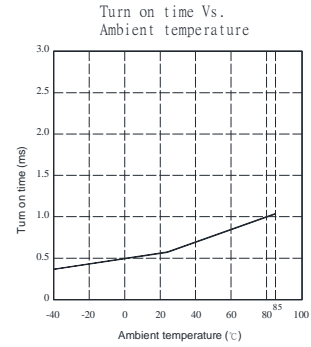
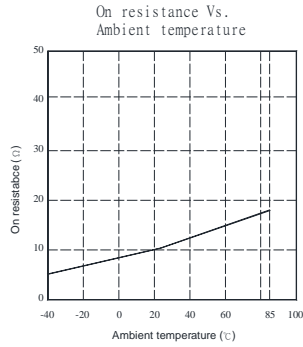
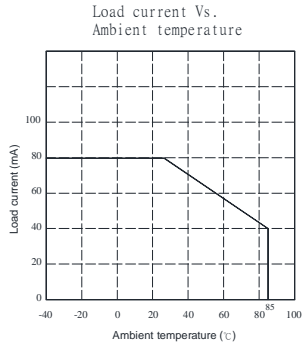

Dimensions

6-SMD



Dimensions

mm inch

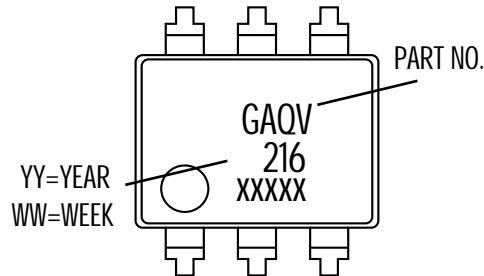

Surface mount terminal type

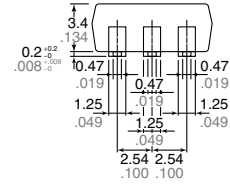
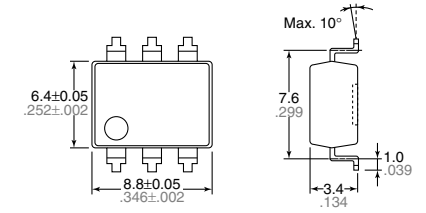

Terminal thickness = 0.25 .010

General tolerance: ±0.1 ±.004

PC board pattern (Top view)

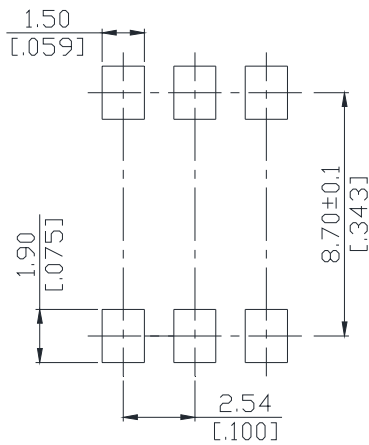

Unit : mm [inch]
Tolerance : ±0.1

Tape dimensions

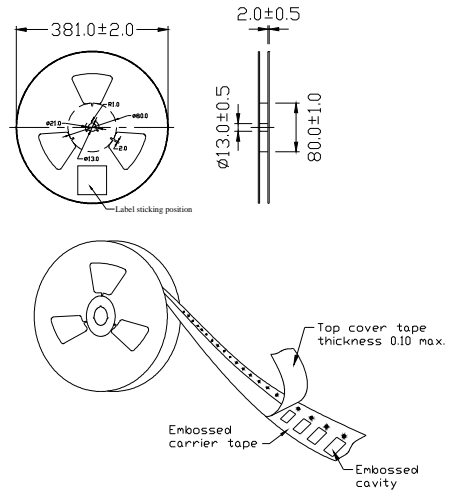

Dimensions of tape reel

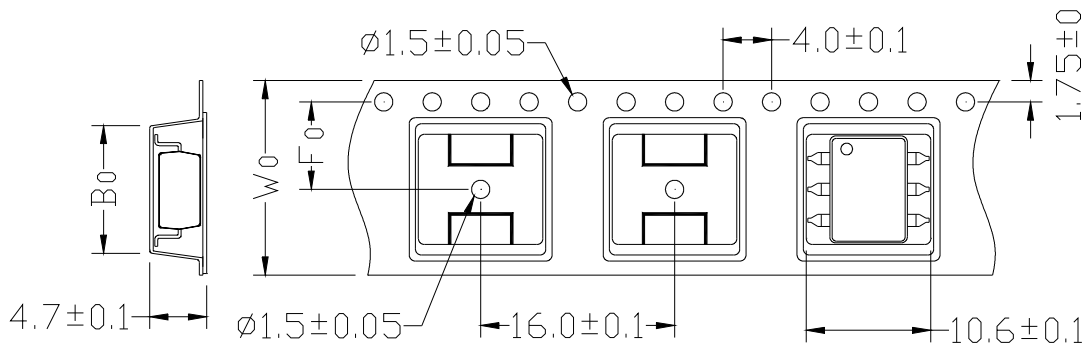

Unit: mm

TYPE	B0±0.1	F0±0.1	W0±0.1	13"REEL/PCS
6P	9.4	7.5	16	1000

Dimensions 6-DIP



Dimensions

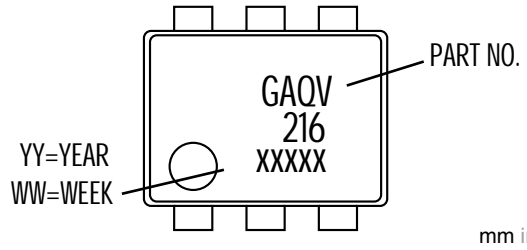

mm inch

Through hole terminal type

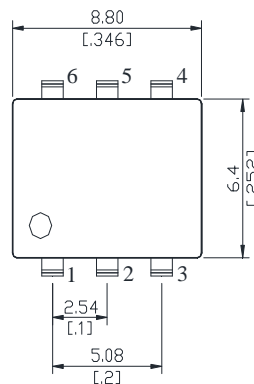
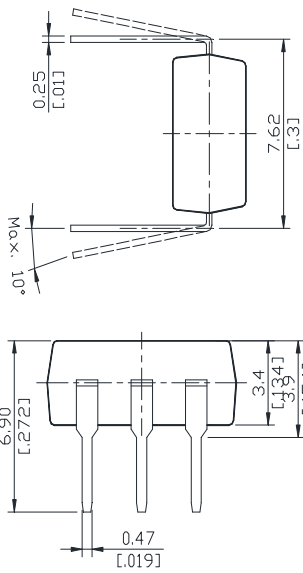

Unit : mm inch
Tolerance: +0.2 +.007

PC board patter

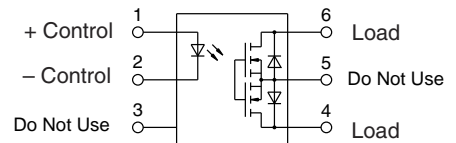
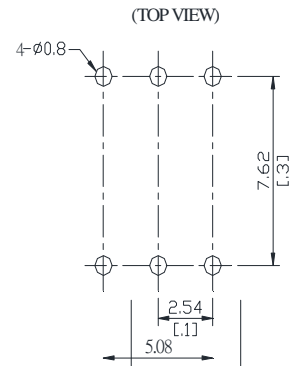

DIP type

Devices are packaged in a tube so that pin No. 1 is on the stopper B side. Observe correct orientation when mounting them on PC boards.

