

Chip Common Mode Choke Coil

DLM11SN□□□HZ2□ Murata Reference Specification [AEC-Q200]

1.Scope

This reference specification applies to Chip Common Mode Choke Coil DLM11S Series for Automotive Electronics based on AEC-Q200 except for Power train and Safety.

2.Part Numbering

(ex.) DL M 11 S N 900 H Z 2 L
 (1) (2) (3) (4) (5) (6) (7) (8) (9) (10)

- | | |
|--|--|
| (1) Chip Common Mode Choke Coil | (6) Impedance (Typ. at 100MHz) |
| (2) Structure (M : Monolithic Type) | (7) Circuit H : Characteristic Impedance 100Ω system |
| (3) Dimension (L×W) | (8) Features |
| (4) Type S: Magnetically shielded one circuit type | (9) Number of Line |
| (5) Category | (10) Packaging Code L : Taping / B : Bulk |

3.Rating

| Customer Part Number | Murata Part Number | Common Mode Impedance (at 100MHz, Under Standard Testing Condition) | Rated Voltage | Withstanding Voltage | Rated Current | DC Resistance | Insulation Resistance | ESD Rank 2:2kV |
|----------------------|--------------------|--|---------------|----------------------|---------------|---------------|-----------------------|-------------------|
| | DLM11SN450HZ2L | 45Ω ±25% | 5V(DC) | 12.5V(DC) | 100mA | 0.7Ω ±25% | 100MΩ min. | 2 |
| | DLM11SN450HZ2B | | | | | 1.1Ω ±25% | | |
| | DLM11SN900HZ2L | 90Ω ±25% | 5V(DC) | 12.5V(DC) | 100mA | 0.7Ω ±25% | 100MΩ min. | 2 |
| | DLM11SN900HZ2B | | | | | 1.1Ω ±25% | | |

Operating Temperature : -55 to +125°C

Storage Temperature : -55 to +125°C

4. Standard Testing Conditions

<Unless otherwise specified>
 Temperature : Ordinary Temperature 15 to 35°C
 Humidity : Ordinary Humidity 25 to 85%(RH)

<In case of doubt>
 Temperature : 20 ± 2°C
 Humidity : 60 to 70%(RH)
 Atmospheric Pressure : 86 to 106kPa

5.Style and Dimensions

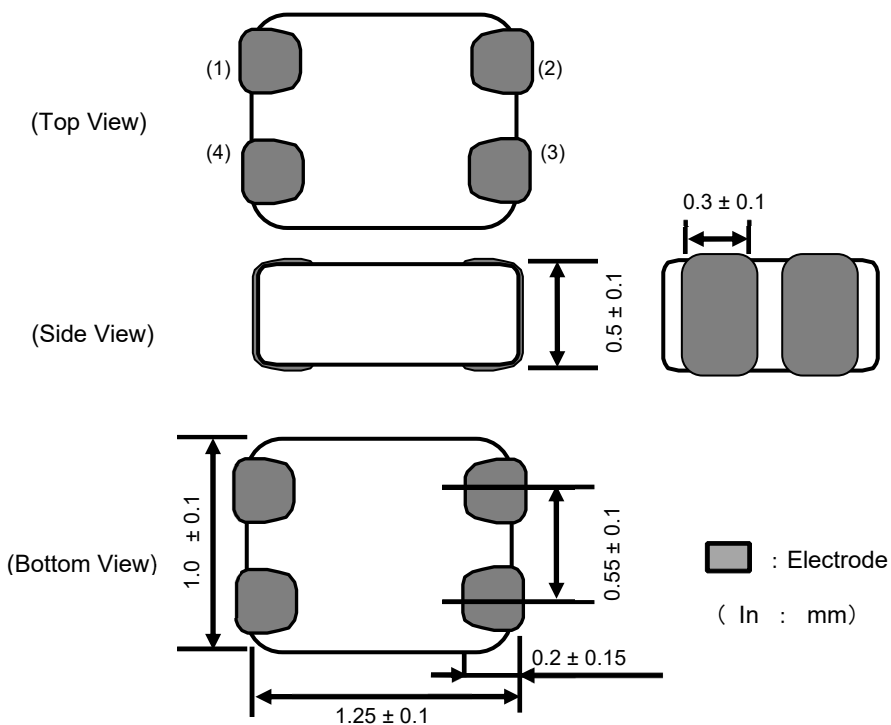

Equivalent Circuits

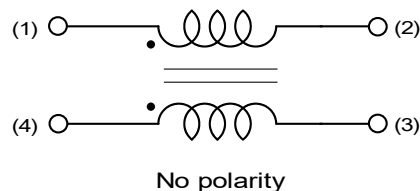

■ Unit Mass (Typical value)
 0.004g

6.Marking

No Marking.

Reference Only

Spec No. JEFL243C-9116F-01

P2/10

7. Electrical Performance

| No. | Item | Specification | Test Method |
|-----|------------------------------|--------------------------------|--|
| 7.1 | Common Mode Impedance | Meet item 3. | Measuring Frequency : 100±1MHz (ref.item 9.) Measuring Equipment : KEYSIGHT 4991A or the equivalents (In case of doubt in standard condition, the heat treatment (200°C, about 10 minutes) shall be applied. |
| 7.2 | Withstanding Voltage | Products shall not be damaged. | Test Voltage : 2.5 times for Rated Voltage Time : 1 to 5 seconds Charge Current : 1 mA max.(ref.item 9.) |
| 7.3 | DC Resistance (Rdc) | Meet item 3. | Measuring current : 10mA max.(ref.item 9.) |
| 7.4 | Insulation Resistance (I.R.) | | Measuring voltage : Rated Voltage Measuring time : 1 minute max. (ref.item 9.) |

8. Q200 Requirement

8-1. Performance (based on Table 13 for Ferrite EMI SUPPRESSORS/FILTERS)

AEC-Q200 Rev.D issued June 1. 2010

| AEC-Q200 | | | Murata Specification / Deviation | | | | | | | | | | |
|------------------------------|-------------------------------|--|---|------------|------------|------------------------------|-------------|------------|-------------|------|------------|----------------------|------------|
| No. | Stress | Test Method | | | | | | | | | | | |
| 3 | High Temperature Exposure | 1000hours at 125 deg C Set for 24hours at room temperature, then measured. | Meet Table A after testing. Table A <table border="1" style="margin-left: 20px;"> <tr> <td>Appearance</td> <td>No damaged</td> </tr> <tr> <td>Common Mode Impedance Change</td> <td>within ±20%</td> </tr> <tr> <td>Rdc change</td> <td>within ±30%</td> </tr> <tr> <td>I.R.</td> <td>100MΩ min.</td> </tr> <tr> <td>Withstanding Voltage</td> <td>No damaged</td> </tr> </table> | Appearance | No damaged | Common Mode Impedance Change | within ±20% | Rdc change | within ±30% | I.R. | 100MΩ min. | Withstanding Voltage | No damaged |
| Appearance | No damaged | | | | | | | | | | | | |
| Common Mode Impedance Change | within ±20% | | | | | | | | | | | | |
| Rdc change | within ±30% | | | | | | | | | | | | |
| I.R. | 100MΩ min. | | | | | | | | | | | | |
| Withstanding Voltage | No damaged | | | | | | | | | | | | |
| 4 | Temperature Cycling | 1000cycles -55 deg C to +125 deg C Set for 24hours at room temperature, then measured. | Meet Table A after testing. | | | | | | | | | | |
| 5 | Destructive Physical Analysis | Per EIA469 No electrical tests | No defects | | | | | | | | | | |
| 7 | Biased Humidity | 1000hours at 85 deg C, 85%RH Apply max rated current. | Meet Table A after testing. (ref.item 9) | | | | | | | | | | |
| 8 | Operational Life | Apply 125 deg C 1000hours Set for 24hours at room temperature, then measured | Meet Table A after testing. Apply rated current. (ref.item 9) | | | | | | | | | | |
| 9 | External Visual | Visual inspection | No abnormalities | | | | | | | | | | |
| 10 | Physical Dimension | Meet ITEM 4 (Style and Dimensions) | No defects | | | | | | | | | | |
| 12 | Resistance to Solvents | Per MIL-STD-202 Method 215 | Not Applicable | | | | | | | | | | |
| 13 | Mechanical Shock | Per MIL-STD-202 Method 213 Condition F: 1500g's(14.7N)/0.5ms/ Half sine | Meet Table A after testing. | | | | | | | | | | |

Reference Only

| AEC-Q200 | | | Murata Specification / Deviation | | | | |
|------------|---------------------------------|--|---|------------|------------|------------|-------------|
| No. | Stress | Test Method | | | | | |
| 14 | Vibration | 5g's(0.049N) for 20 minutes, 12cycles each of 3 orientations Test from 10-2000Hz. 12cycles each of 3 orientations | Meet Table A after testing. | | | | |
| 15 | Resistance to Soldering Heat | Solder temperature 260C+/-5 deg C Immersion time 10s | Meet Table A after testing. | | | | |
| 17 | ESD | Per AEC-Q200-002 | ESD Rank: Refer to Item 3. Rating. Meet Table B after testing. <table border="1" style="margin-left: auto; margin-right: auto;"> <caption>Table B</caption> <tr> <td style="padding: 2px;">Appearance</td> <td style="padding: 2px;">No damaged</td> </tr> <tr> <td style="padding: 2px;">Rdc change</td> <td style="padding: 2px;">within ±30%</td> </tr> </table> | Appearance | No damaged | Rdc change | within ±30% |
| Appearance | No damaged | | | | | | |
| Rdc change | within ±30% | | | | | | |
| 18 | Solderbility | Per J-STD-002 | Method b : Not Applicable 95% of the terminations is to be soldered. Flux:Ethanol solution of rosin,25(wt)% includes activator equivalent to 0.06 to 0.10(wt)% chlorine | | | | |
| 19 | Electrical Characterization | Measured : Common mode Impedance | No defects | | | | |
| 20 | Flammability | Per UL-94 | Not Applicable | | | | |
| 21 | Board Flex | Epoxy-PCB(1.6mm) Deflection 2mm(min) 60 sec minimum holding time. | Meet Table B after testing. | | | | |
| 22 | Terminal Strength | Per AEC-Q200-006 A force of 17.7N for 60sec | 5N for 30s No defects | | | | |
| 30 | Electrical Transient Conduction | Per ISO-7637-2 | Not Applicable | | | | |

9. Terminal to be Tested.

When measuring and supplying the voltage,the following terminal is applied.

| No. | Item | Terminal to be Tested |
|-----|--|-----------------------|
| 9.1 | Common Mode Impedance | |
| 9.2 | Withstanding Voltage Insulation Resistance | |
| 9.3 | DC Resistance | |
| 9.4 | Biased Humidity (Supply Terminal) | |
| 9.5 | Operational Life (Supply Terminal) | |

10. Measuring method for common mode impedance.

Measured common mode impedance may be included measurement error due to stray capacitance, residual inductance of test fixture.

To correct this error, the common mode impedance should be calculate as follows;

- (1) Measure admittance of the fixture(opened), G_o B_o .
- (2) Measure impedance of the fixture(shorted), R_s X_s .
- (3) Measure admittance of the specimen, G_m B_m .
- (4) Calculate corrected impedance $|Z|$ using the formula below.

$$|Z| = (R_x^2 + X_x^2)^{1/2}$$

Where

$$R_x = \frac{G_m - G_o}{(G_m - G_o)^2 + (B_m - B_o)^2} - R_s$$

$$X_x = \frac{-(B_m - B_o)}{(G_m - G_o)^2 + (B_m - B_o)^2} - X_s$$

11. P.C.B., Flux, Solder and Soldering condition

Test shall be done using P.C.B., Flux, Solder and Soldering condition which are specified in item 16 except the case of being specified special condition.

12. Impedance Frequency Characteristics(Typical)

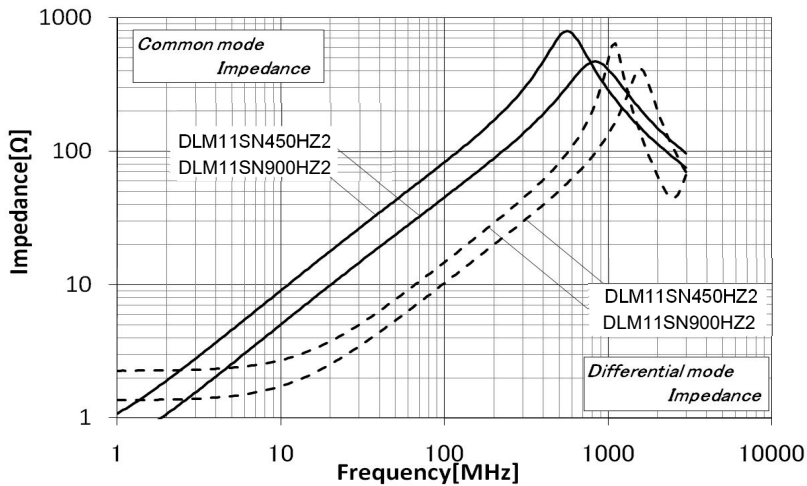

13. Specification of Packaging

13.1 Appearance and Dimensions (8mm-wide,Plastic tape)

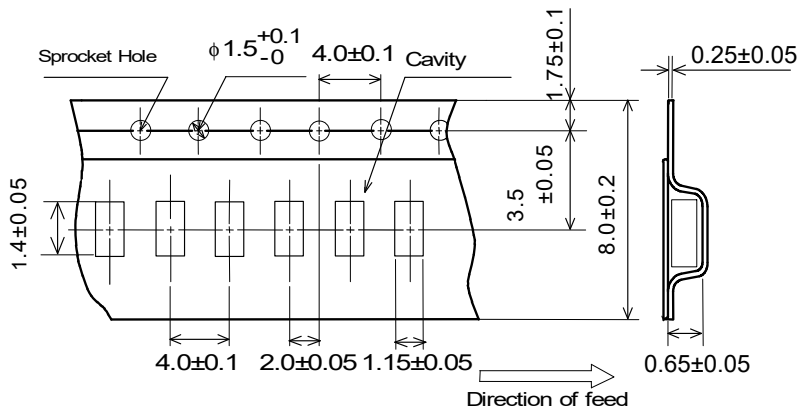

*Dimension of the Cavity is measured at the bottom side.

(in:mm)

13.2 Specification of Taping

- (1)Packing quantity(Standard quantity) 4000 pcs. / reel Direction of feed
- (2)Packing Method
Products shall be packaged in each embossed cavity of plastic tape and sealed with cover tape.
- (3)Sprocket Hole
The sprocket holes are to the right as the tape is pulled toward the user.
- (4)Spliced point
The cover tape have no spliced point.
- (5)Missing components number
Missing components number within 0.025% of the number per reel or 1 pc., whichever is greater, and are not continuous. The specified quantity per reel is kept.

13.3 Pull Strength of Plastic Tape

| | |
|--------------|----------|
| Plastic Tape | 5N min. |
| Cover Tape | 10N min. |

13.4 Peeling off force of Cover Tape

0.2 to 0.7N(Minimum value is Typical)
Speed of Peeling off : 300 mm/min.

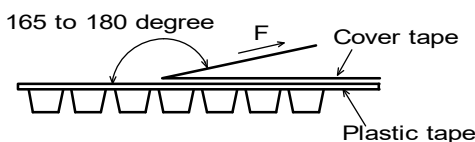

13.5 Dimensions of Leader-tape, Trailer and Reel

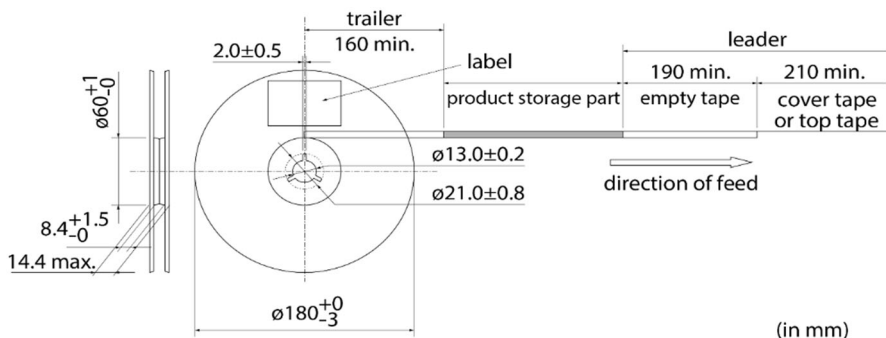

(in mm)

13.6 Marking for reel

Customer part number, MURATA part number, Inspection number(*1), RoHS Marking(*2), Quantity, etc

*1) « Expression of Inspection No. »

$\square\square$ (1) $\square\square\square$ (2) $\square\square\square$ (3)

(1) Factory Code
(2) Date

First digit : Year / Last digit of year
Second digit : Month / Jan. to Sep. → 1 to 9, Oct. to Dec. → O,N,D
Third, Fourth digit : Day

(3) Serial No.

*2) « Expression of RoHS Marking »

ROHS – Y (Δ)
(1) (2)

(1) RoHS regulation conformity parts.
(2) MURATA classification number

13.7 Marking for Outside package

Customer name Purchasing Order Number, Customer Part Number, MURATA part number, RoHS Marking (*2), Quantity, etc

13.8 Specification of Outer Case

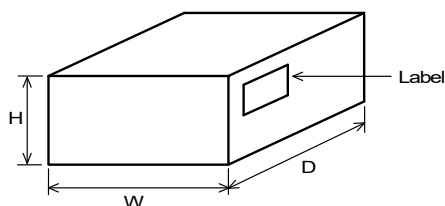

| Outer Case Dimensions (mm) | | | Standard Reel Quantity in Outer Case (Reel) |
|----------------------------|-----|----|---|
| W | D | H | |
| 186 | 186 | 93 | 5 |

* Above Outer Case size is typical. It depends on a quantity of an order.

14. Caution

14.1 Mounting Direction

Mount products in right direction.

Wrong direction which is 90° rotated from right direction causes not only open or short circuit but also flames or other serious trouble.

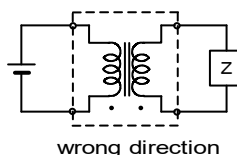
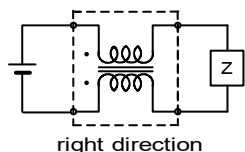

14.2 Limitation of Applications

Please contact us before using our products for the applications listed below which require especially high reliability for the prevention of defects which might directly cause damage to the third party's life, body or property.

- | | |
|-----------------------------------|--|
| (1) Aircraft equipment | (6) Transportation equipment (trains, ships, etc.) |
| (2) Aerospace equipment | (7) Traffic signal equipment |
| (3) Undersea equipment | (8) Disaster prevention / crime prevention equipment |
| (4) Power plant control equipment | (9) Data-processing equipment |
| (5) Medical equipment | (10) Applications of similar complexity and / or reliability requirements to the applications listed in the above. |

14.3 Fail-safe

Be sure to provide an appropriate fail-safe function on your product to prevent a second damage that may be caused by the abnormal function or the failure of our product.

14.4 Corrosive gas

Please refrain from use since contact with environments with corrosive gases (sulfur gas [hydrogen sulfide, sulfur dioxide, etc.], chlorine, ammonia, etc.) or oils (cutting oil, silicone oil, etc.) that have come into contact with the previously stated corrosive gas environment will result in deterioration of product quality or an open from deterioration due to corrosion of product electrode, etc. We will not bear any responsibility for use under these environments.

15. Notice

This product is designed for solder mounting. (reflow soldering only)
Please consult us in advance for applying other mounting method such as conductive adhesive.

15.1 Flux and Solder

| | |
|--------|--|
| Flux | Use rosin-based flux, but not highly acidic flux (with chlorine content exceeding 0.2(wt)%.) Do not use water-soluble flux. |
| Solder | Use Sn-3.0Ag-0.5Cu solder Use of Sn-Zn based solder will deteriorate performance of products. In case of using Sn-Zn based solder, please contact Murata in advance. |

15.2 Assembling

<Thermal Shock>

Pre-heating should be in such a way that the temperature difference between solder and ceramic surface is limited to 100°C MAX. Also cooling into solvent after soldering should be in such a way that the temperature difference is limited to 100°C max.

15.3 Resin coating

The impedance value may change and/or it may affect on the product's performance due to high cure-stress of resin to be used for coating / molding products. So please pay your careful attention when you select resin. In prior to use, please make the reliability evaluation with the product mounted in your application set.

15.4 Attention regarding P.C.B. bending

The following shall be considered when designing and laying out P.C.B.'s.

- (1) P.C.B. shall be designed so that products are not subject to the mechanical stress due to warping the board.

[Products direction]

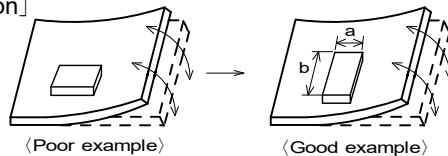

Products shall be location the sideways Direction (Length : a<b) to the machanical Stress.

- (2) Components location on P.C.B. separation

It is effective to implement the following measures, to reduce stress in separating the board.
It is best to implement all of the following three measures; however, implement as many measures as possible to reduce stress.

| Contents of Measures | Stress Level |
|--|--------------|
| (1) Turn the mounting direction of the component parallel to the board separation surface. | A > D *1 |
| (2) Add slits in the board separation part. | A > B |
| (3) Keep the mounting position of the component away from the board separation surface. | A > C |

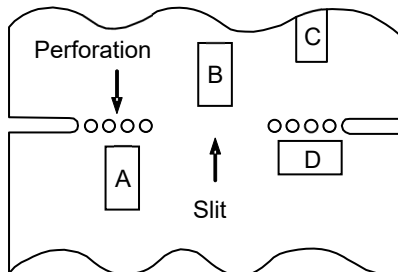

*1 A > D is valid when stress is added vertically to the perforation as with Hand Separation.
If a Cutting Disc is used, stress will be diagonal to the PCB, therefore A > D is invalid.

(3) Mounting Components Near Screw Holes

When a component is mounted near a screw hole, it may be affected by the board deflection that occurs during the tightening of the screw. Mount the component in a position as far away from the screw holes as possible.

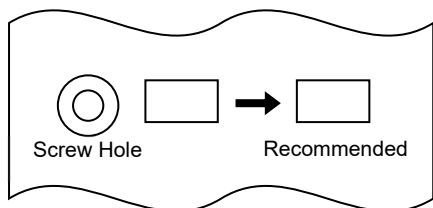

15.5 Attention Regarding P.C.B. Design

< The Arrangement of Products >

P.C.B. shall be designed so that products are far from the portion of perforation.

The portion of perforation shall be designed as narrow as possible, and shall be designed so as not to be applied the stress in the case of P.C.B. separation.

Products shall not be arranged on the line of a series of holes when there are big holes in P.C.B. (Because the stress concentrate on the line of holes.)

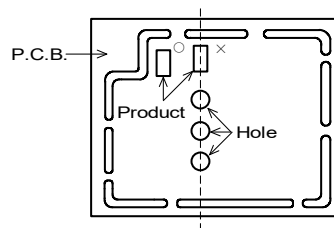
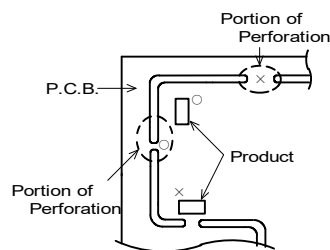

< Products Placing >

Support pins shall be set under P.C.B. to prevent causing a warp to P.C.B. during placing the products on the other side of P.C.B.

< P.C.B. Separation >

P.C.B. shall not be separated with hand.

P.C.B. shall be separated with the fixture so as not to cause P.C.B. bending.

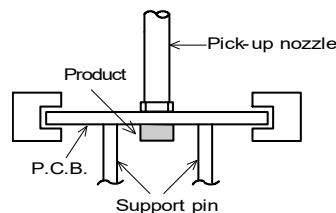

15.6 Attention Regarding P.C.B. Mounting

In case of mounting by use of mounting machine, please choose nozzle which can pick up components of 1005 size or the equivalents.

15.7 Standard Land Dimensions

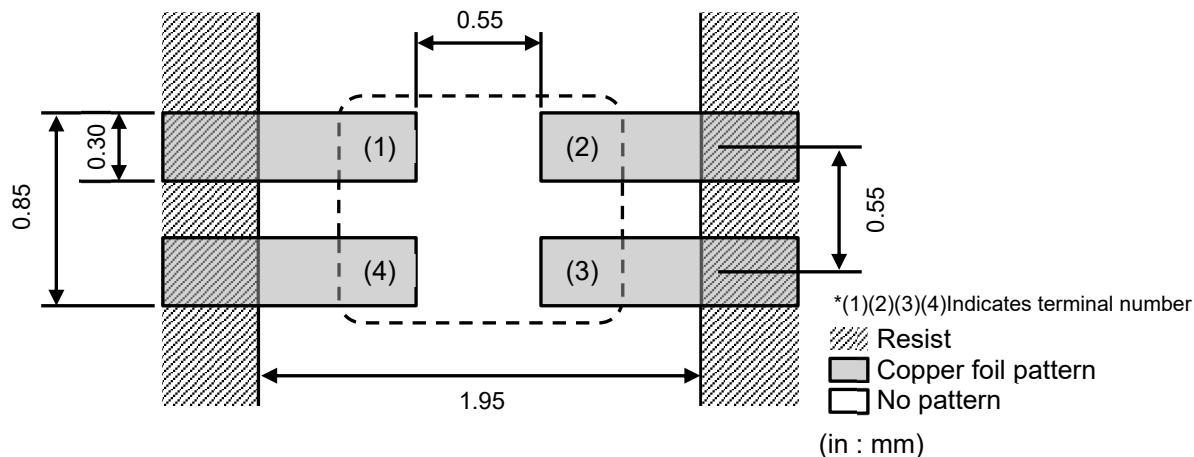

15.8 Soldering(Reflow soldering)

Standard soldering profile and the limit soldering profile is as follows.

The excessive limit soldering conditions may cause leaching of the electrode and / or resulting in the deterioration of product quality.

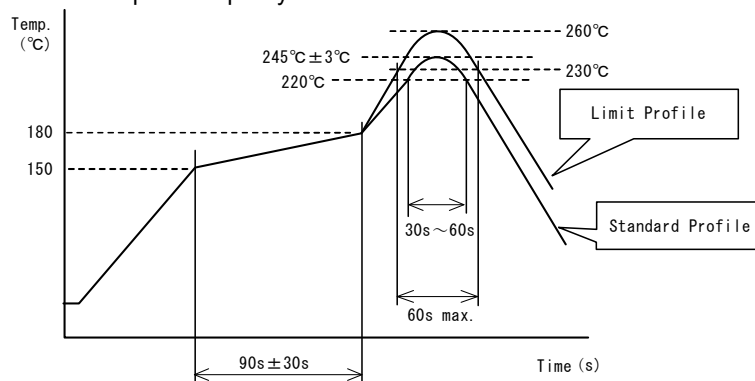

| | Standard Profile | Limit Profile |
|------------------|---------------------|----------------------|
| Pre-heating | 150~180°C、90s±30s | |
| Heating | above 220°C、30s~60s | above 230°C、60s max. |
| Peak temperature | 245±3°C | 260°C、10s |
| Cycle of reflow | 2 times | 2 times |

(1) Standard printing pattern of solder paste

- Standard thickness of the solder paste should be 100 to 150µm.
- Use the solder paste printing pattern of the right pattern.
- For the resist and copper foil pattern, use standard land dimensions.
- Use Sn-3.0Ag-0.5Cu solder.

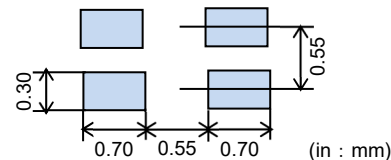

(2) Reworking with Soldering iron

- The following conditions shall be strictly followed when using a soldering iron after being mounted by reflow soldering.
 - Pre-heating: 150°C, 1 min
 - Soldering iron output: 30W max.
 - Tip temperature: 380°C max.
 - Tip diameter: φ3mm max.
 - Soldering time : 3(+1,-0) seconds.
 - Times : 2times max.
- Do not touch the products directly with the tip of the soldering iron.

(3) Solder Volume

Solder shall be used not to be exceed the upper limits as shown below.

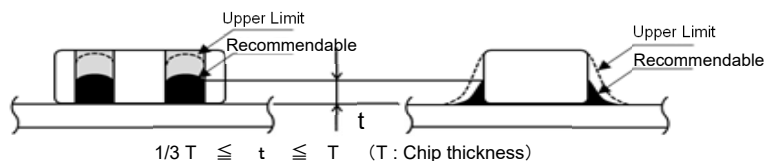

Accordingly increasing the solder volume, the mechanical stress to product is also increased. Excessive solder volume may cause the failure of mechanical or electrical performance.

15.9 Cleaning Conditions

Products shall be cleaned on the following conditions.

- (1) Cleaning temperature shall be limited to 60°C max. (40°C max. for Isopropyl alcohol.)
- (2) Ultrasonic cleaning shall comply with the following conditions, avoiding the resonance phenomenon at the mounted products and P.C.B..
 - Power : 20W/ l max.
 - Frequency : 28kHz to 40kHz
 - Time : 5 minutes max.
- (3) Cleaner
 1. Alternative cleaner • Isopropyl alcohol (IPA)
 2. Aqueous agent • PINE ALPHA ST-100S
- (4) There shall be no residual flux and residual cleaner after cleaning.

In the case of using aqueous agent, products shall be dried completely after rinse with de-ionized water in order to remove the cleaner.
- (5) Other cleaning
Please contact us.

15.10 Handling of a substrate

After mounting products on a substrate, do not apply any stress to the product caused by bending or twisting to the substrate when cropping the substrate, inserting and removing a connector from the substrate or tightening screw to the substrate.

Excessive mechanical stress may cause cracking in the product.

Bending

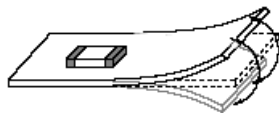

Twisting

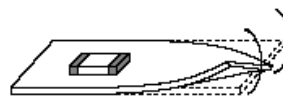

15.11 Operating Environment

Do not use this product under the following environmental conditions, on deterioration of the performance, such as insulation resistance may result from the use.

- (1) in the corrodible atmosphere such as acidic gases, alkaline gases, chlorine, sulfur gases, organic gases and etc (the sea breeze, Cl₂, H₂S, NH₃, SO₂, NO₂, etc)
- (2) in the atmosphere where liquid such as organic solvent, may splash on the products.

15.12 Storage Conditions

(1) Storage period

Use the products within 12 months after delivered.

Solderability should be checked if this period is exceeded.

(2) Storage environment condition

- Products should be stored in the warehouse on the following conditions.

Temperature : -10 to +40°C

Humidity : 15 to 85% relative humidity

No rapid change on temperature and humidity

- Products should not be stored in corrosive gases, such as sulfurous, acid gases, alkaline gases, to prevent the following deterioration.
Poor solderability due to the oxidized electrode.

- Products should be stored on the palette for the prevention of the influence from humidity, dust and so on.
- Products should be stored in the warehouse without heat shock, vibration, direct sunlight and so on.
- Avoid storing the product by itself bare (i.e. exposed directly to air).

(3) Delivery

Care should be taken when transporting or handling product to avoid excessive vibration or mechanical shock.

16. Note

- (1) Please make sure that your product has been evaluated in view of your specifications with our product being mounted to your product.
- (2) You are requested not to use our product deviating from the reference specifications.
- (3) The contents of this reference specification are subject to change without advance notice. Please approve our product specifications or transact the approval sheet for product specifications before ordering.

Mouser Electronics

Authorized Distributor

Click to View Pricing, Inventory, Delivery & Lifecycle Information:

[Murata:](#)

[DLM11SN450HZ2L](#) [DLM11SN900HZ2L](#)