

Reference Specification

Leaded MLCC for General Purpose
RDE Series

Product specifications in this catalog are as of Mar. 2022, and are subject to change or obsolescence without notice.
Please consult the approval sheet before ordering. Please read rating and Cautions first.

⚠ CAUTION**1. OPERATING VOLTAGE**

When DC-rated capacitors are to be used in AC or ripple current circuits, be sure to maintain the V_{p-p} value of the applied voltage or the V_{o-p} which contains DC bias within the rated voltage range. When the voltage is started to apply to the circuit or it is stopped applying, the irregular voltage may be generated for a transit period because of resonance or switching. Be sure to use a capacitor within rated voltage containing these irregular voltage.

When DC-rated capacitors are to be used in input circuits from commercial power source (AC filter), be sure to use Safety Recognized Capacitors because various regulations on withstand voltage or impulse withstand established for each equipment should be taken into considerations.

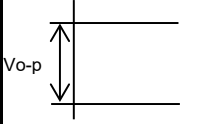
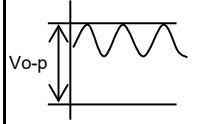
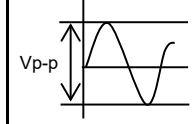
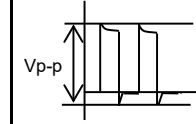
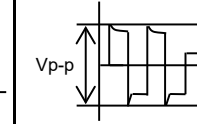
Voltage	DC Voltage	DC+AC Voltage	AC Voltage	Pulse Voltage(1)	Pulse Voltage(2)
Positional Measurement					

2. OPERATING TEMPERATURE AND SELF-GENERATED HEAT

Keep the surface temperature of a capacitor below the upper limit of its rated operating temperature range. Be sure to take into account the heat generated by the capacitor itself.

When the capacitor is used in a high-frequency current, pulse current or the like, it may have the self-generated heat due to dielectric-loss. In case of Class 2 capacitors (Temp.Char. : X7R,X7S,X8L, etc.), applied voltage should be the load such as self-generated heat is within 20 °C on the condition of atmosphere temperature 25 °C. Please contact us if self-generated heat is occurred with Class 1 capacitors (Temp.Char. : C0G,U2J,X8G, etc.). When measuring, use a thermocouple of small thermal capacity-K of $\Phi 0.1\text{mm}$ and be in the condition where capacitor is not affected by radiant heat of other components and wind of surroundings. Excessive heat may lead to deterioration of the capacitor's characteristics and reliability.

3. FAIL-SAFE

Be sure to provide an appropriate fail-safe function on your product to prevent a second damage that may be caused by the abnormal function or the failure of our product.

4. OPERATING AND STORAGE ENVIRONMENT

The insulating coating of capacitors does not form a perfect seal; therefore, do not use or store capacitors in a corrosive atmosphere, especially where chloride gas, sulfide gas, acid, alkali, salt or the like are present. And avoid exposure to moisture. Before cleaning, bonding, or molding this product, verify that these processes do not affect product quality by testing the performance of a cleaned, bonded or molded product in the intended equipment. Store the capacitors where the temperature and relative humidity do not exceed 5 to 40 °C and 20 to 70%. Use capacitors within 6 months.

5. VIBRATION AND IMPACT

Do not expose a capacitor or its leads to excessive shock or vibration during use.

6. SOLDERING

When soldering this product to a PCB/PWB, do not exceed the solder heat resistance specification of the capacitor. Subjecting this product to excessive heating could melt the internal junction solder and may result in thermal shocks that can crack the ceramic element.

7. BONDING AND RESIN MOLDING, RESIN COAT

In case of bonding, molding or coating this product, verify that these processes do not affect the quality of capacitor by testing the performance of a bonded or molded product in the intended equipment.

In case of the amount of applications, dryness / hardening conditions of adhesives and molding resins containing organic solvents (ethyl acetate, methyl ethyl ketone, toluene, etc.) are unsuitable, the outer coating resin of a capacitor is damaged by the organic solvents and it may result, worst case, in a short circuit.

The variation in thickness of adhesive or molding resin may cause a outer coating resin cracking and/or ceramic element cracking of a capacitor in a temperature cycling.

8. TREATMENT AFTER BONDING AND RESIN MOLDING, RESIN COAT

When the outer coating is hot (over 100 °C) after soldering, it becomes soft and fragile.

So please be careful not to give it mechanical stress.

Failure to follow the above cautions may result, worst case, in a short circuit and cause fuming or partial dispersion when the product is used.

9. LIMITATION OF APPLICATIONS

Please contact us before using our products for the applications listed below which require especially high reliability for the prevention of defects which might directly cause damage to the third party's life, body or property.

- | | |
|----------------------------------------------------------------------------------------------------------------|-------------------------------------------------------------|
| 1. Aircraft equipment | 2. Aerospace equipment |
| 3. Undersea equipment | 4. Power plant control equipment |
| 5. Medical equipment | 6. Transportation equipment (vehicles, trains, ships, etc.) |
| 7. Traffic signal equipment | 8. Disaster prevention / crime prevention equipment |
| 9. Data-processing equipment exerting influence on public | |
| 10. Application of similar complexity and/or reliability requirements to the applications listed in the above. | |

NOTICE

1. CLEANING (ULTRASONIC CLEANING)

To perform ultrasonic cleaning, observe the following conditions.

Rinse bath capacity : Output of 20 watts per liter or less.

Rinsing time : 5 min maximum.

Do not vibrate the PCB/PWB directly.

Excessive ultrasonic cleaning may lead to fatigue destruction of the lead wires.

2. SOLDERING AND MOUNTING

Insertion of the Lead Wire

- When soldering, insert the lead wire into the PCB without mechanically stressing the lead wire.
- Insert the lead wire into the PCB with a distance appropriate to the lead space.

3. CAPACITANCE CHANGE OF CAPACITORS

- Class 2 capacitors (Temp.Char. : X7R,X7S,X8L etc.)

Class 2 capacitors an aging characteristic, whereby the capacitor continually decreases its capacitance slightly if the capacitor leaves for a long time. Moreover, capacitance might change greatly depending on a surrounding temperature or an applied voltage. So, it is not likely to be able to use for the time constant circuit.

Please contact us if you need a detail information.

NOTE

1. Please make sure that your product has been evaluated in view of your specifications with our product being mounted to your product.
2. You are requested not to use our product deviating from this specification.

1. Application

This product specification is applied to Leaded MLCC RDE series used for General Electronic equipment.

Do not use these products in any automotive power train or safety equipment including battery chargers for electric vehicles and plug-in hybrids.

2. Rating

• Part Number Configuration

ex.)	RDE	R7	2E	102	K	1	K1	H03	B
	Series	Temperature Characteristics	Rated Voltage	Capacitance	Capacitance Tolerance	Dimension (LxW)	Lead Style	Individual Specification	Package

• Temperature Characteristics

Code	Temp. Char.	Temp. Range	Cap. Change	Standard Temp.	Operating Temp. Range
R7	X7R (EIA code)	-55~125°C	+/-15%	25°C	-55~125°C

• Rated Voltage

Code	Rated voltage
2E	DC250V
2H	DC500V
2J	DC630V
3A	DC1000V

• Capacitance

The first two digits denote significant figures ; the last digit denotes the multiplier of 10 in pF.

ex.) In case of 102

$$10 \times 10^2 = 1000\text{pF}$$

• Capacitance Tolerance

Code	Capacitance Tolerance
K	+/-10%
M	+/-20%

• Dimension (LxW)

Please refer to [Part number list].

• Lead Style

*Lead wire is "solder coated CP wire".

Code	Lead Style	Lead spacing (mm)
B1	Straight type	5.0+/-0.8
E1	Straight taping type	5.0+0.6/-0.2
K1	Inside crimp type	5.0+/-0.8
M1	Inside crimp taping type	5.0+0.6/-0.2

• Individual Specification

Murata's control code.

Please refer to [Part number list].











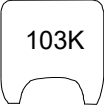



• Package

Code	Package
A	Taping type of Ammo
B	Bulk type

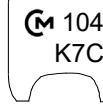
3. Marking

- Temp. char. : Letter code : C (X7R Char. Except dimension code : 1)
 Capacitance : 3 digit numbers
 Capacitance tolerance : Code
 Rated voltage : Letter code : 4 (DC250V. Except dimension code : 1)
 Letter code : 9 (DC500V. Except dimension code : 1)
 Letter code : 7 (DC630V)
 Letter code : A (DC1000V)
 Company name code : Abbreviation :  (Except dimension code : 1)

(Ex.)

Rated voltage / Dimension code	DC250V	DC500V	DC630V	DC1000V
1			—	—
2				
3,4				
5,U				

4. Part number list

- Inside Crimp
(Lead Style : K*)

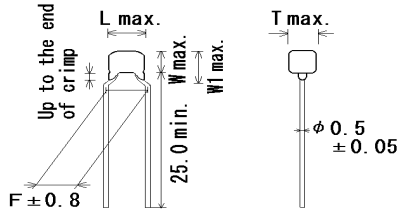

- Straight Long
(Lead Style : B1)

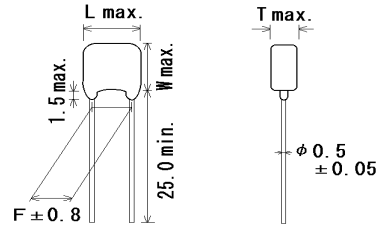

Unit : mm

Customer Part Number	Murata Part Number	T.C.	DC Rated Volt. (V)	Cap.	Cap. Tol.	Dimension (mm)					Dimension (LxW) Lead Style	Pack qty. (pcs)
						L	W	W1	F	T		
	RDER72E102K1K1H03B	X7R	250	1000pF	±10%	4.5	3.5	5.0	5.0	3.15	1K1	500
	RDER72E152K1K1H03B	X7R	250	1500pF	±10%	4.5	3.5	5.0	5.0	3.15	1K1	500
	RDER72E222K1K1H03B	X7R	250	2200pF	±10%	4.5	3.5	5.0	5.0	3.15	1K1	500
	RDER72E332K1K1H03B	X7R	250	3300pF	±10%	4.5	3.5	5.0	5.0	3.15	1K1	500
	RDER72E472K1K1H03B	X7R	250	4700pF	±10%	4.5	3.5	5.0	5.0	3.15	1K1	500
	RDER72E682K1K1H03B	X7R	250	6800pF	±10%	4.5	3.5	5.0	5.0	3.15	1K1	500
	RDER72E103K1K1H03B	X7R	250	10000pF	±10%	4.5	3.5	5.0	5.0	3.15	1K1	500
	RDER72E153K1K1H03B	X7R	250	15000pF	±10%	4.5	3.5	5.0	5.0	3.15	1K1	500
	RDER72E223K1K1H03B	X7R	250	22000pF	±10%	4.5	3.5	5.0	5.0	3.15	1K1	500
	RDER72E333K2K1H03B	X7R	250	33000pF	±10%	5.5	4.0	6.0	5.0	3.15	2K1	500
	RDER72E473K2K1H03B	X7R	250	47000pF	±10%	5.5	4.0	6.0	5.0	3.15	2K1	500
	RDER72E683K2K1H03B	X7R	250	68000pF	±10%	5.5	4.0	6.0	5.0	3.15	2K1	500
	RDER72E104K2K1H03B	X7R	250	0.1μF	±10%	5.5	4.0	6.0	5.0	3.15	2K1	500
	RDER72E154K3K1H03B	X7R	250	0.15μF	±10%	5.5	5.0	7.5	5.0	4.0	3K1	500
	RDER72E224K3K1H03B	X7R	250	0.22μF	±10%	5.5	5.0	7.5	5.0	4.0	3K1	500
	RDER72E334K4K1H03B	X7R	250	0.33μF	±10%	7.5	5.5	8.0	5.0	4.0	4K1	500
	RDER72E474K4K1H03B	X7R	250	0.47μF	±10%	7.5	5.5	8.0	5.0	4.0	4K1	500
	RDER72E684K5B1H03B	X7R	250	0.68μF	±10%	7.5	7.5	-	5.0	4.5	5B1	500
	RDER72E105K5B1H03B	X7R	250	1.0μF	±10%	7.5	7.5	-	5.0	4.5	5B1	500

- Straight Long
(Dimension(LxW) Lead Style:UB1)

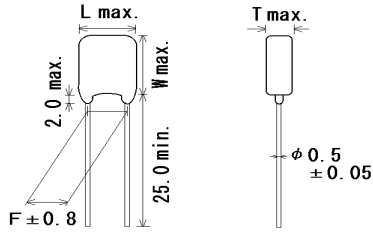

- Inside Crimp
(Lead Style :K*)

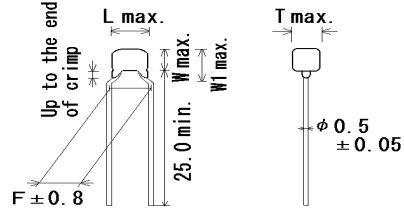

Unit : mm

Customer Part Number	Murata Part Number	T.C.	DC Rated Volt. (V)	Cap.	Cap. Tol.	Dimension (mm)					Dimension (LxW) Lead Style	Pack qty. (pcs)
						L	W	W1	F	T		
	RDER72E225MUB1H03B	X7R	250	2.2μF	±20%	7.7	12.5	-	5.0	4.5	UB1	200
	RDER72H102K1K1H03B	X7R	500	1000pF	±10%	4.5	3.5	5.0	5.0	3.15	1K1	500
	RDER72H152K1K1H03B	X7R	500	1500pF	±10%	4.5	3.5	5.0	5.0	3.15	1K1	500
	RDER72H222K1K1H03B	X7R	500	2200pF	±10%	4.5	3.5	5.0	5.0	3.15	1K1	500
	RDER72H332K1K1H03B	X7R	500	3300pF	±10%	4.5	3.5	5.0	5.0	3.15	1K1	500
	RDER72H472K1K1H03B	X7R	500	4700pF	±10%	4.5	3.5	5.0	5.0	3.15	1K1	500
	RDER72H682K1K1H03B	X7R	500	6800pF	±10%	4.5	3.5	5.0	5.0	3.15	1K1	500
	RDER72H103K1K1H03B	X7R	500	10000pF	±10%	4.5	3.5	5.0	5.0	3.15	1K1	500
	RDER72H153K2K1H03B	X7R	500	15000pF	±10%	5.5	4.0	6.0	5.0	3.15	2K1	500
	RDER72H223K2K1H03B	X7R	500	22000pF	±10%	5.5	4.0	6.0	5.0	3.15	2K1	500
	RDER72H333K2K1H03B	X7R	500	33000pF	±10%	5.5	4.0	6.0	5.0	3.15	2K1	500
	RDER72H473K2K1H03B	X7R	500	47000pF	±10%	5.5	4.0	6.0	5.0	3.15	2K1	500
	RDER72H683K3K1H03B	X7R	500	68000pF	±10%	5.5	5.0	7.5	5.0	4.0	3K1	500
	RDER72H104K3K1H03B	X7R	500	0.1μF	±10%	5.5	5.0	7.5	5.0	4.0	3K1	500
	RDER72H154K4K1H03B	X7R	500	0.15μF	±10%	7.5	5.5	8.0	5.0	4.0	4K1	500
	RDER72H224K4K1H03B	X7R	500	0.22μF	±10%	7.5	5.5	8.0	5.0	4.0	4K1	500

- Straight Long
(Lead Style: B1)

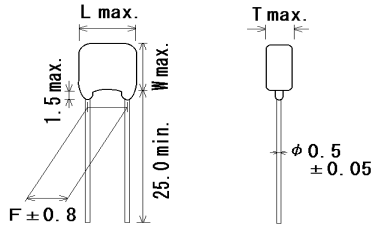

- Straight Long
(Dimension (LxW) Lead Style: UB1)

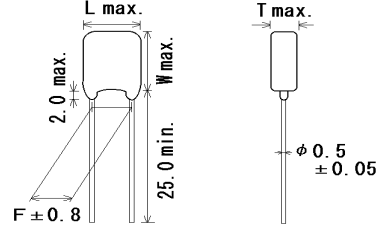

Unit : mm

Customer Part Number	Murata Part Number	T.C.	DC Rated Volt. (V)	Cap.	Cap. Tol.	Dimension (mm)					Dimension (LxW) Lead Style	Pack qty. (pcs)
						L	W	W1	F	T		
	RDER72H334K5B1H03B	X7R	500	0.33 μ F	\pm 10%	7.5	7.5	-	5.0	4.5	5B1	500
	RDER72H474K5B1H03B	X7R	500	0.47 μ F	\pm 10%	7.5	7.5	-	5.0	4.5	5B1	500
	RDER72H684MUB1H03B	X7R	500	0.68 μ F	\pm 20%	7.7	12.5	-	5.0	4.5	UB1	200
	RDER72H105MUB1H03B	X7R	500	1.0 μ F	\pm 20%	7.7	12.5	-	5.0	4.5	UB1	200

- Inside Crimp
(Lead Style: K*)

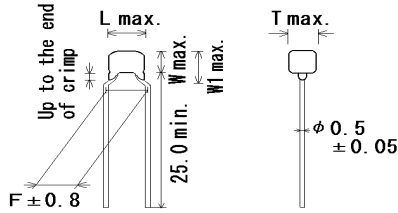

- Straight Long
(Lead Style: B1)

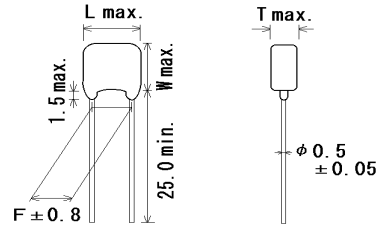

Unit : mm

Customer Part Number	Murata Part Number	T.C.	DC Rated Volt. (V)	Cap.	Cap. Tol.	Dimension (mm)					Dimension (LxW) Lead Style	Pack qty. (pcs)
						L	W	W1	F	T		
	RDER72J102K2K1H03B	X7R	630	1000pF	±10%	5.5	4.0	6.0	5.0	3.15	2K1	500
	RDER72J152K2K1H03B	X7R	630	1500pF	±10%	5.5	4.0	6.0	5.0	3.15	2K1	500
	RDER72J222K2K1H03B	X7R	630	2200pF	±10%	5.5	4.0	6.0	5.0	3.15	2K1	500
	RDER72J332K2K1H03B	X7R	630	3300pF	±10%	5.5	4.0	6.0	5.0	3.15	2K1	500
	RDER72J472K2K1H03B	X7R	630	4700pF	±10%	5.5	4.0	6.0	5.0	3.15	2K1	500
	RDER72J682K2K1H03B	X7R	630	6800pF	±10%	5.5	4.0	6.0	5.0	3.15	2K1	500
	RDER72J103K2K1H03B	X7R	630	10000pF	±10%	5.5	4.0	6.0	5.0	3.15	2K1	500
	RDER72J153K2K1H03B	X7R	630	15000pF	±10%	5.5	4.0	6.0	5.0	3.15	2K1	500
	RDER72J223K2K1H03B	X7R	630	22000pF	±10%	5.5	4.0	6.0	5.0	3.15	2K1	500
	RDER72J333K3K1H03B	X7R	630	33000pF	±10%	5.5	5.0	7.5	5.0	4.0	3K1	500
	RDER72J473K3K1H03B	X7R	630	47000pF	±10%	5.5	5.0	7.5	5.0	4.0	3K1	500
	RDER72J683K4K1H03B	X7R	630	68000pF	±10%	7.5	5.5	8.0	5.0	4.0	4K1	500
	RDER72J104K4K1H03B	X7R	630	0.1μF	±10%	7.5	5.5	8.0	5.0	4.0	4K1	500
	RDER72J154K5B1H03B	X7R	630	0.15μF	±10%	7.5	8.0	-	5.0	4.5	5B1	500
	RDER72J224K5B1H03B	X7R	630	0.22μF	±10%	7.5	8.0	-	5.0	4.5	5B1	500

- Straight Long
(Dimension (LxW) Lead Style:UB1)

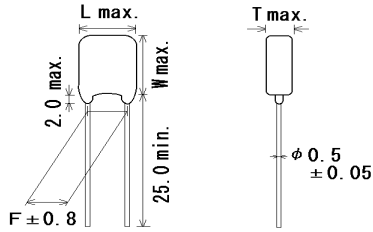

- Inside Crimp
(Lead Style :K*)

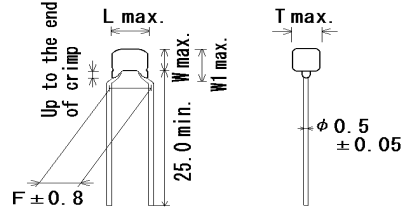

Unit : mm

Customer Part Number	Murata Part Number	T.C.	DC Rated Volt. (V)	Cap.	Cap. Tol.	Dimension (mm)					Dimension (LxW) Lead Style	Pack qty. (pcs)
						L	W	W1	F	T		
	RDER72J474MUB1H03B	X7R	630	0.47μF	±20%	7.7	13.0	-	5.0	4.0	UB1	200
	RDER73A471K2K1H03B	X7R	1000	470pF	±10%	5.5	4.0	6.0	5.0	3.15	2K1	500
	RDER73A681K2K1H03B	X7R	1000	680pF	±10%	5.5	4.0	6.0	5.0	3.15	2K1	500
	RDER73A102K2K1H03B	X7R	1000	1000pF	±10%	5.5	4.0	6.0	5.0	3.15	2K1	500
	RDER73A152K2K1H03B	X7R	1000	1500pF	±10%	5.5	4.0	6.0	5.0	3.15	2K1	500
	RDER73A222K2K1H03B	X7R	1000	2200pF	±10%	5.5	4.0	6.0	5.0	3.15	2K1	500
	RDER73A332K2K1H03B	X7R	1000	3300pF	±10%	5.5	4.0	6.0	5.0	3.15	2K1	500
	RDER73A472K2K1H03B	X7R	1000	4700pF	±10%	5.5	4.0	6.0	5.0	3.15	2K1	500
	RDER73A682K2K1H03B	X7R	1000	6800pF	±10%	5.5	4.0	6.0	5.0	3.15	2K1	500
	RDER73A103K2K1H03B	X7R	1000	10000pF	±10%	5.5	4.0	6.0	5.0	3.15	2K1	500
	RDER73A153K3K1H03B	X7R	1000	15000pF	±10%	5.5	5.0	7.5	5.0	4.0	3K1	500
	RDER73A223K3K1H03B	X7R	1000	22000pF	±10%	5.5	5.0	7.5	5.0	4.0	3K1	500
	RDER73A333K4K1H03B	X7R	1000	33000pF	±10%	7.5	5.5	8.0	5.0	4.0	4K1	500
	RDER73A473K4K1H03B	X7R	1000	47000pF	±10%	7.5	5.5	8.0	5.0	4.0	4K1	500

- Straight Long
(Lead Style: B1)

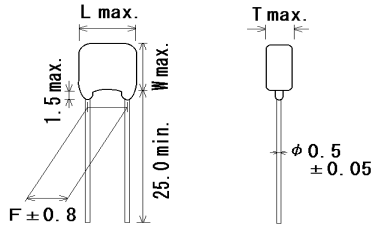

- Straight Long
(Dimension(LxW) Lead Style: UB1)

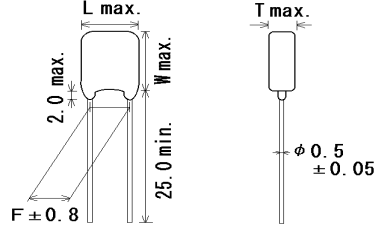

Unit : mm

Customer Part Number	Murata Part Number	T.C.	DC Rated Volt. (V)	Cap.	Cap. Tol.	Dimension (mm)					Dimension (LxW) Lead Style	Pack qty. (pcs)
						L	W	W1	F	T		
	RDER73A683K5B1H03B	X7R	1000	68000pF	±10%	7.5	8.0	-	5.0	4.5	5B1	500
	RDER73A104K5B1H03B	X7R	1000	0.1µF	±10%	7.5	8.0	-	5.0	4.5	5B1	500
	RDER73A224MUB1H03B	X7R	1000	0.22µF	±20%	7.7	13.0	-	5.0	4.0	UB1	200

• Inside Crimp Taping
(Lead Style: M*)

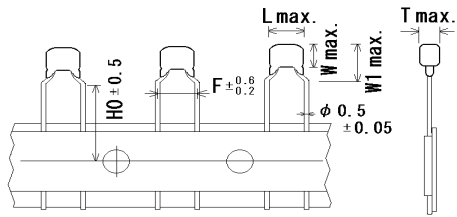

• Straight Taping
(Lead Style: E*)

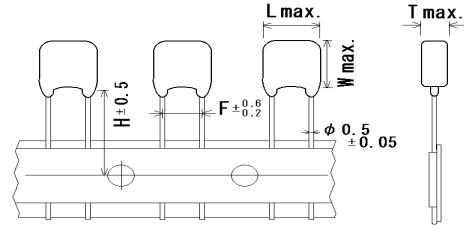

Unit : mm

Customer Part Number	Murata Part Number	T.C.	DC Rated Volt. (V)	Cap.	Cap. Tol.	Dimension (mm)						Dimension (LxW) Lead Style	Pack qty. (pcs)
						L	W	W1	F	T	H/H0		
	RDER72E102K1M1H03A	X7R	250	1000pF	±10%	4.5	3.5	5.0	5.0	3.15	16.0	1M1	2000
	RDER72E152K1M1H03A	X7R	250	1500pF	±10%	4.5	3.5	5.0	5.0	3.15	16.0	1M1	2000
	RDER72E222K1M1H03A	X7R	250	2200pF	±10%	4.5	3.5	5.0	5.0	3.15	16.0	1M1	2000
	RDER72E332K1M1H03A	X7R	250	3300pF	±10%	4.5	3.5	5.0	5.0	3.15	16.0	1M1	2000
	RDER72E472K1M1H03A	X7R	250	4700pF	±10%	4.5	3.5	5.0	5.0	3.15	16.0	1M1	2000
	RDER72E682K1M1H03A	X7R	250	6800pF	±10%	4.5	3.5	5.0	5.0	3.15	16.0	1M1	2000
	RDER72E103K1M1H03A	X7R	250	10000pF	±10%	4.5	3.5	5.0	5.0	3.15	16.0	1M1	2000
	RDER72E153K1M1H03A	X7R	250	15000pF	±10%	4.5	3.5	5.0	5.0	3.15	16.0	1M1	2000
	RDER72E223K1M1H03A	X7R	250	22000pF	±10%	4.5	3.5	5.0	5.0	3.15	16.0	1M1	2000
	RDER72E333K2M1H03A	X7R	250	33000pF	±10%	5.5	4.0	6.0	5.0	3.15	16.0	2M1	2000
	RDER72E473K2M1H03A	X7R	250	47000pF	±10%	5.5	4.0	6.0	5.0	3.15	16.0	2M1	2000
	RDER72E683K2M1H03A	X7R	250	68000pF	±10%	5.5	4.0	6.0	5.0	3.15	16.0	2M1	2000
	RDER72E104K2M1H03A	X7R	250	0.1μF	±10%	5.5	4.0	6.0	5.0	3.15	16.0	2M1	2000
	RDER72E154K3M1H03A	X7R	250	0.15μF	±10%	5.5	5.0	7.5	5.0	4.0	16.0	3M1	2000
	RDER72E224K3M1H03A	X7R	250	0.22μF	±10%	5.5	5.0	7.5	5.0	4.0	16.0	3M1	2000
	RDER72E334K4M1H03A	X7R	250	0.33μF	±10%	7.5	5.5	8.0	5.0	4.0	16.0	4M1	1500
	RDER72E474K4M1H03A	X7R	250	0.47μF	±10%	7.5	5.5	8.0	5.0	4.0	16.0	4M1	1500
	RDER72E684K5E1H03A	X7R	250	0.68μF	±10%	7.5	7.5	-	5.0	4.5	17.5	5E1	1500
	RDER72E105K5E1H03A	X7R	250	1.0μF	±10%	7.5	7.5	-	5.0	4.5	17.5	5E1	1500
	RDER72E225MUE1H03A	X7R	250	2.2μF	±20%	7.7	12.5	-	5.0	4.5	17.5	UE1	1500

• Inside Crimp Taping
(Lead Style: M*)

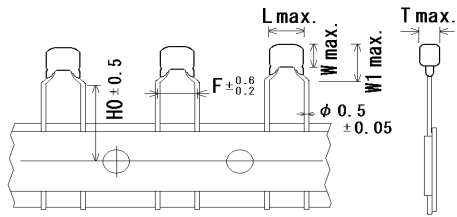

• Straight Taping
(Lead Style: E*)

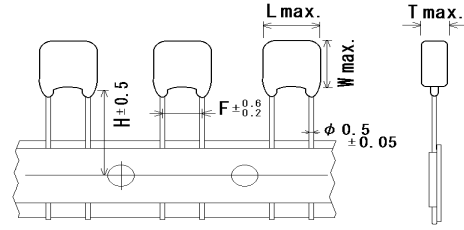

Unit : mm

Customer Part Number	Murata Part Number	T.C.	DC Rated Volt. (V)	Cap.	Cap. Tol.	Dimension (mm)						Dimension (LxW) Lead Style	Pack qty. (pcs)
						L	W	W1	F	T	H/H0		
	RDER72H102K1M1H03A	X7R	500	1000pF	±10%	4.5	3.5	5.0	5.0	3.15	16.0	1M1	2000
	RDER72H152K1M1H03A	X7R	500	1500pF	±10%	4.5	3.5	5.0	5.0	3.15	16.0	1M1	2000
	RDER72H222K1M1H03A	X7R	500	2200pF	±10%	4.5	3.5	5.0	5.0	3.15	16.0	1M1	2000
	RDER72H332K1M1H03A	X7R	500	3300pF	±10%	4.5	3.5	5.0	5.0	3.15	16.0	1M1	2000
	RDER72H472K1M1H03A	X7R	500	4700pF	±10%	4.5	3.5	5.0	5.0	3.15	16.0	1M1	2000
	RDER72H682K1M1H03A	X7R	500	6800pF	±10%	4.5	3.5	5.0	5.0	3.15	16.0	1M1	2000
	RDER72H103K1M1H03A	X7R	500	10000pF	±10%	4.5	3.5	5.0	5.0	3.15	16.0	1M1	2000
	RDER72H153K2M1H03A	X7R	500	15000pF	±10%	5.5	4.0	6.0	5.0	3.15	16.0	2M1	2000
	RDER72H223K2M1H03A	X7R	500	22000pF	±10%	5.5	4.0	6.0	5.0	3.15	16.0	2M1	2000
	RDER72H333K2M1H03A	X7R	500	33000pF	±10%	5.5	4.0	6.0	5.0	3.15	16.0	2M1	2000
	RDER72H473K2M1H03A	X7R	500	47000pF	±10%	5.5	4.0	6.0	5.0	3.15	16.0	2M1	2000
	RDER72H683K3M1H03A	X7R	500	68000pF	±10%	5.5	5.0	7.5	5.0	4.0	16.0	3M1	2000
	RDER72H104K3M1H03A	X7R	500	0.1μF	±10%	5.5	5.0	7.5	5.0	4.0	16.0	3M1	2000
	RDER72H154K4M1H03A	X7R	500	0.15μF	±10%	7.5	5.5	8.0	5.0	4.0	16.0	4M1	1500
	RDER72H224K4M1H03A	X7R	500	0.22μF	±10%	7.5	5.5	8.0	5.0	4.0	16.0	4M1	1500
	RDER72H334K5E1H03A	X7R	500	0.33μF	±10%	7.5	7.5	-	5.0	4.5	17.5	5E1	1500
	RDER72H474K5E1H03A	X7R	500	0.47μF	±10%	7.5	7.5	-	5.0	4.5	17.5	5E1	1500
	RDER72H684MUE1H03A	X7R	500	0.68μF	±20%	7.7	12.5	-	5.0	4.5	17.5	UE1	1500
	RDER72H105MUE1H03A	X7R	500	1.0μF	±20%	7.7	12.5	-	5.0	4.5	17.5	UE1	1500

• Inside Crimp Taping
(Lead Style: M*)

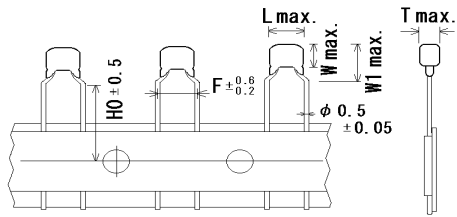

• Straight Taping
(Lead Style: E*)

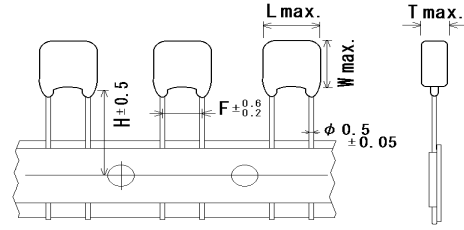

Unit : mm

Customer Part Number	Murata Part Number	T.C.	DC Rated Volt. (V)	Cap.	Cap. Tol.	Dimension (mm)						Dimension (LxW) Lead Style	Pack qty. (pcs)
						L	W	W1	F	T	H/H0		
	RDER72J102K2M1H03A	X7R	630	1000pF	±10%	5.5	4.0	6.0	5.0	3.15	16.0	2M1	2000
	RDER72J152K2M1H03A	X7R	630	1500pF	±10%	5.5	4.0	6.0	5.0	3.15	16.0	2M1	2000
	RDER72J222K2M1H03A	X7R	630	2200pF	±10%	5.5	4.0	6.0	5.0	3.15	16.0	2M1	2000
	RDER72J332K2M1H03A	X7R	630	3300pF	±10%	5.5	4.0	6.0	5.0	3.15	16.0	2M1	2000
	RDER72J472K2M1H03A	X7R	630	4700pF	±10%	5.5	4.0	6.0	5.0	3.15	16.0	2M1	2000
	RDER72J682K2M1H03A	X7R	630	6800pF	±10%	5.5	4.0	6.0	5.0	3.15	16.0	2M1	2000
	RDER72J103K2M1H03A	X7R	630	10000pF	±10%	5.5	4.0	6.0	5.0	3.15	16.0	2M1	2000
	RDER72J153K2M1H03A	X7R	630	15000pF	±10%	5.5	4.0	6.0	5.0	3.15	16.0	2M1	2000
	RDER72J223K2M1H03A	X7R	630	22000pF	±10%	5.5	4.0	6.0	5.0	3.15	16.0	2M1	2000
	RDER72J333K3M1H03A	X7R	630	33000pF	±10%	5.5	5.0	7.5	5.0	4.0	16.0	3M1	2000
	RDER72J473K3M1H03A	X7R	630	47000pF	±10%	5.5	5.0	7.5	5.0	4.0	16.0	3M1	2000
	RDER72J683K4M1H03A	X7R	630	68000pF	±10%	7.5	5.5	8.0	5.0	4.0	16.0	4M1	1500
	RDER72J104K4M1H03A	X7R	630	0.1μF	±10%	7.5	5.5	8.0	5.0	4.0	16.0	4M1	1500
	RDER72J154K5E1H03A	X7R	630	0.15μF	±10%	7.5	8.0	-	5.0	4.5	17.5	5E1	1500
	RDER72J224K5E1H03A	X7R	630	0.22μF	±10%	7.5	8.0	-	5.0	4.5	17.5	5E1	1500
	RDER72J474MUE1H03A	X7R	630	0.47μF	±20%	7.7	13.0	-	5.0	4.0	17.5	UE1	1500

• Inside Crimp Taping
(Lead Style: M*)

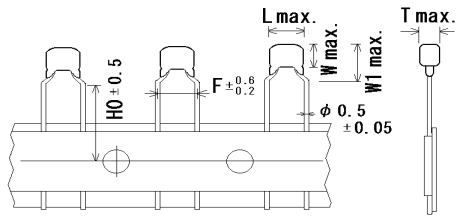

• Straight Taping
(Lead Style: E*)

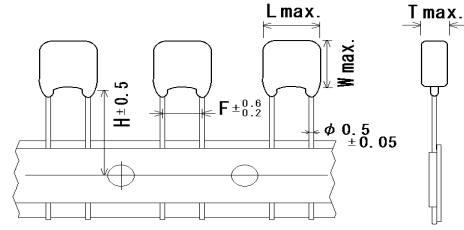

Unit : mm

Customer Part Number	Murata Part Number	T.C.	DC Rated Volt. (V)	Cap.	Cap. Tol.	Dimension (mm)						Dimension (LxW) Lead Style	Pack qty. (pcs)
						L	W	W1	F	T	H/H0		
	RDER73A471K2M1H03A	X7R	1000	470pF	±10%	5.5	4.0	6.0	5.0	3.15	16.0	2M1	2000
	RDER73A681K2M1H03A	X7R	1000	680pF	±10%	5.5	4.0	6.0	5.0	3.15	16.0	2M1	2000
	RDER73A102K2M1H03A	X7R	1000	1000pF	±10%	5.5	4.0	6.0	5.0	3.15	16.0	2M1	2000
	RDER73A152K2M1H03A	X7R	1000	1500pF	±10%	5.5	4.0	6.0	5.0	3.15	16.0	2M1	2000
	RDER73A222K2M1H03A	X7R	1000	2200pF	±10%	5.5	4.0	6.0	5.0	3.15	16.0	2M1	2000
	RDER73A332K2M1H03A	X7R	1000	3300pF	±10%	5.5	4.0	6.0	5.0	3.15	16.0	2M1	2000
	RDER73A472K2M1H03A	X7R	1000	4700pF	±10%	5.5	4.0	6.0	5.0	3.15	16.0	2M1	2000
	RDER73A682K2M1H03A	X7R	1000	6800pF	±10%	5.5	4.0	6.0	5.0	3.15	16.0	2M1	2000
	RDER73A103K2M1H03A	X7R	1000	10000pF	±10%	5.5	4.0	6.0	5.0	3.15	16.0	2M1	2000
	RDER73A153K3M1H03A	X7R	1000	15000pF	±10%	5.5	5.0	7.5	5.0	4.0	16.0	3M1	2000
	RDER73A223K3M1H03A	X7R	1000	22000pF	±10%	5.5	5.0	7.5	5.0	4.0	16.0	3M1	2000
	RDER73A333K4M1H03A	X7R	1000	33000pF	±10%	7.5	5.5	8.0	5.0	4.0	16.0	4M1	1500
	RDER73A473K4M1H03A	X7R	1000	47000pF	±10%	7.5	5.5	8.0	5.0	4.0	16.0	4M1	1500
	RDER73A683K5E1H03A	X7R	1000	68000pF	±10%	7.5	8.0	-	5.0	4.5	17.5	5E1	1500
	RDER73A104K5E1H03A	X7R	1000	0.1μF	±10%	7.5	8.0	-	5.0	4.5	17.5	5E1	1500
	RDER73A224MUE1H03A	X7R	1000	0.22μF	±20%	7.7	13.0	-	5.0	4.0	17.5	UE1	1500

Reference only

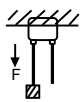
5. SPECIFICATIONS AND TEST METHODS																
No.	Item		Specification	Test Method												
1	Appearance		No defects or abnormalities.	Visual inspection.												
2	Dimension and Marking		Within the specified dimensions and Marking.	Visual inspection, Using Caliper.												
3	Dielectric Strength	Between Terminals	No defects or abnormalities.	The capacitor should not be damaged when voltage in Table is applied between the terminations for 1 to 5 seconds. (Charge/Discharge current \leq 50mA.) <table border="1" style="margin-left: 20px;"> <thead> <tr> <th>Rated voltage</th> <th>Test voltage</th> </tr> </thead> <tbody> <tr> <td>DC250V</td> <td>200% of the rated voltage</td> </tr> <tr> <td>DC500V, DC630V</td> <td>150% of the rated voltage</td> </tr> <tr> <td>DC1kV</td> <td>120% of the rated voltage</td> </tr> </tbody> </table>	Rated voltage	Test voltage	DC250V	200% of the rated voltage	DC500V, DC630V	150% of the rated voltage	DC1kV	120% of the rated voltage				
	Rated voltage	Test voltage														
DC250V	200% of the rated voltage															
DC500V, DC630V	150% of the rated voltage															
DC1kV	120% of the rated voltage															
3		Body Insulation	No defects or abnormalities.	The capacitor is placed in a container with metal balls of 1mm diameter so that each terminal, short-circuit, is kept approximately 2mm from the balls as shown in the figure, for 1 to 5 seconds between capacitor terminals and metal balls. (Charge/Discharge current \leq 50mA.) <table border="1" style="margin-left: 20px;"> <thead> <tr> <th>Rated voltage</th> <th>Test voltage</th> </tr> </thead> <tbody> <tr> <td>DC250V, DC500V</td> <td>200% of the rated voltage</td> </tr> <tr> <td>DC630V, DC1kV</td> <td>DC1300V</td> </tr> </tbody> </table>	Rated voltage	Test voltage	DC250V, DC500V	200% of the rated voltage	DC630V, DC1kV	DC1300V						
	Rated voltage	Test voltage														
DC250V, DC500V	200% of the rated voltage															
DC630V, DC1kV	DC1300V															
4	Insulation Resistance (I.R.)	Between Terminals	10 000M Ω or 100M Ω · μ F min. (Whichever is smaller)	The insulation resistance should be measured with DC500V (DC250V in case of rated voltage : DC250V) at normal temperature and humidity and within 2 minutes of charging. (Charge/Discharge current \leq 50mA.)												
5	Capacitance		Within the specified tolerance.	The capacitance, D.F. should be measured at 25°C at the frequency and voltage shown in the table.												
6	Dissipation Factor (D.F.)		0.025 max.	<table border="1" style="margin-left: 20px;"> <thead> <tr> <th>Nominal Cap.</th> <th>Frequency</th> <th>Voltage</th> </tr> </thead> <tbody> <tr> <td>C \leq 1000pF</td> <td>1\pm0.1MHz</td> <td>AC0.5~5V (r.m.s.)</td> </tr> <tr> <td>C > 1000pF</td> <td>1\pm0.1kHz</td> <td>AC1\pm0.2V (r.m.s.)</td> </tr> </tbody> </table>	Nominal Cap.	Frequency	Voltage	C \leq 1000pF	1 \pm 0.1MHz	AC0.5~5V (r.m.s.)	C > 1000pF	1 \pm 0.1kHz	AC1 \pm 0.2V (r.m.s.)			
Nominal Cap.	Frequency	Voltage														
C \leq 1000pF	1 \pm 0.1MHz	AC0.5~5V (r.m.s.)														
C > 1000pF	1 \pm 0.1kHz	AC1 \pm 0.2V (r.m.s.)														
7	Capacitance Temperature Characteristics		within \pm 15%	The capacitance change should be measured at each specified temperature stage. <table border="1" style="margin-left: 20px;"> <thead> <tr> <th>Step</th> <th>Temperature(°C)</th> </tr> </thead> <tbody> <tr> <td>1</td> <td>25\pm2</td> </tr> <tr> <td>2</td> <td>-55\pm3</td> </tr> <tr> <td>3</td> <td>25\pm2</td> </tr> <tr> <td>4</td> <td>125\pm3</td> </tr> <tr> <td>5</td> <td>25\pm2</td> </tr> </tbody> </table> <p>• Pretreatment Perform a heat treatment at 150+0/-10°C for one hour and then set at *room condition temperature for 24\pm2 hours.</p>	Step	Temperature(°C)	1	25 \pm 2	2	-55 \pm 3	3	25 \pm 2	4	125 \pm 3	5	25 \pm 2
Step	Temperature(°C)															
1	25 \pm 2															
2	-55 \pm 3															
3	25 \pm 2															
4	125 \pm 3															
5	25 \pm 2															
8	Terminal Strength	Tensile Strength	Termination not to be broken or loosened.	As in the figure, fix the capacitor body, apply the force gradually to each lead in the radial direction of the capacitor until reaching 10N and then keep the force applied for 10 \pm 1 seconds. 												
		Bending Strength	Termination not to be broken or loosened.	Each lead wire should be subjected to a force of 2.5N and then be bent 90° at the point of egress in one direction. Each wire is then returned to the original position and bent 90° in the opposite direction at the rate of one bend per 2 to 3 seconds.												
9	Vibration Resistance	Appearance	No defects or abnormalities.	The capacitor should be subjected to a simple harmonic motion having a total amplitude of 1.5mm, the frequency being varied uniformly between the approximate limits of 10Hz and 55Hz. The frequency range, from 10Hz to 55Hz and return to 10Hz, shall be traversed in approximately 1 minute. This motion shall be applied for a period of 2 hours in each 3 mutually perpendicular directions (total of 6 hours).												
		Capacitance	Within the specified tolerance.													
		D.F.	0.025max.													
10	Solderability of Lead		Solder is deposited on unintermittently immersed portion in axial direction covering 3/4 or more in circumferential direction of lead wires.	The terminal of capacitor is dipped into a solution of ethanol (JIS K 8101) and rosin (JIS K 5902) (25% rosin in weight proportion). Immerse in solder solution for 2 \pm 0.5 seconds. In both cases the depth of dipping is up to about 1.5 to 2mm from the terminal body. Temp. of solder : 245 \pm 5°C Lead Free Solder (Sn-3.0Ag-0.5Cu) 235 \pm 5°C H60A or H63A Eutectic Solder												

* "room condition" Temperature : 15 to 35°C, Relative humidity : 45 to 75%, Atmosphere pressure : 86 to 106kPa

Reference only

No.	Item	Specification	Test Method																
11-1	Resistance to Soldering Heat (Non-Preheat)	Appearance	The lead wires should be immersed in the melted solder 1.5 to 2.0mm from the root of terminal at 260±5°C for 10±1 seconds. • Pre-treatment Capacitor should be stored at 150+0/-10°C for one hour, then place at *room condition for 24±2 hours before initial measurement. • Post-treatment Capacitor should be stored for 24±2 hours at *room condition.																
		Capacitance Change																	
		Dielectric Strength (Between terminals)																	
11-2	Resistance to Soldering Heat (On-Preheat)	Appearance	First the capacitor should be stored at 120+0/-5°C for 60+0/-5 seconds. Then, the lead wires should be immersed in the melted solder 1.5 to 2.0mm from the root of terminal at 260±5°C for 7.5+0/-1 seconds. • Pre-treatment Capacitor should be stored at 150+0/-10°C for one hour, then place at *room condition for 24±2 hours before initial measurement. • Post-treatment Capacitor should be stored for 24±2 hours at *room condition.																
		Capacitance Change																	
		Dielectric Strength (Between terminals)																	
11-3	Resistance to Soldering Heat (soldering iron method)	Appearance	Test condition Temperature of iron-tip : 350±10°C Soldering time : 3.5±0.5 seconds Soldering position Straight Lead : 1.5 to 2.0mm from the root of terminal. Crimp Lead : 1.5 to 2.0mm from the end of lead bend. • Pre-treatment Capacitor should be stored at 150+0/-10°C for one hour, then place at *room condition for 24±2 hours before initial measurement. • Post-treatment Capacitor should be stored for 24±2 hours at *room condition.																
		Capacitance Change																	
		Dielectric Strength (Between terminals)																	
12	Temperature Cycle	Appearance	Repeat 5 cycles according to the 4 heat treatments listed in the following table. Set at *room condition for 24±2 hours, then measure.																
		Capacitance Change																	
		D.F.																	
		I.R.																	
		Dielectric Strength (Between Terminals)																	
		<table border="1"> <thead> <tr> <th>Step</th> <th>1</th> <th>2</th> <th>3</th> <th>4</th> </tr> </thead> <tbody> <tr> <td>Temp. (°C)</td> <td>Min. Operating Temp. ±3</td> <td>Room Temp.</td> <td>Max. Operating Temp. ±3</td> <td>Room Temp.</td> </tr> <tr> <td>Time (min.)</td> <td>30±3</td> <td>3 max.</td> <td>30±3</td> <td>3 max.</td> </tr> </tbody> </table>			Step	1	2	3	4	Temp. (°C)	Min. Operating Temp. ±3	Room Temp.	Max. Operating Temp. ±3	Room Temp.	Time (min.)	30±3	3 max.	30±3	3 max.
Step	1	2	3	4															
Temp. (°C)	Min. Operating Temp. ±3	Room Temp.	Max. Operating Temp. ±3	Room Temp.															
Time (min.)	30±3	3 max.	30±3	3 max.															
		• Pretreatment Perform a heat treatment at 150+0/-10°C for one hour and then set at *room condition for 24±2 hours.																	
13	Humidity (Steady State)	Appearance	Set the capacitor at 40±2°C and relative humidity 90 to 95% for 500+24/-0 hours. Remove and set at *room condition for 24±2 hours, then measure. • Pretreatment Perform a heat treatment at 150+0/-10°C for one hour and then set at *room condition for 24±2 hours.																
		Capacitance Change																	
		D.F.																	
		I.R.																	
		Marking																	
14	Humidity Load	Appearance	Apply the rated voltage at 40±2°C and relative humidity of 90 to 95% for 500+24/-0 hours. Remove and set at *room condition for 24±2 hours, then measure. (Charge/Discharge current ≤ 50mA.) • Pretreatment Perform a heat treatment at 150+0/-10°C for one hour and then set at *room condition for 24±2 hours.																
		Capacitance Change																	
		D.F.																	
		I.R.																	
* "room condition" Temperature : 15 to 35°C, Relative humidity : 45 to 75%, Atmosphere pressure : 86 to 106kPa																			

Reference only

No.	Item	Specification	Test Method								
15	High Temperature Load	Appearance	Apply voltage in Table for 1000+48/-0 hours at the maximum operating temperature $\pm 3^{\circ}\text{C}$. Remove and set at *room condition for 24 \pm 2 hours, then measure. (Charge/Discharge current $\leq 50\text{mA}$.)								
		Capacitance Change									
		D.F.									
		I.R.									
		No defects or abnormalities. Within $\pm 12.5\%$ 0.04 max. 1,000M Ω or 50M $\Omega \cdot \mu\text{F}$ min. (Whichever is smaller)	<table border="1"> <thead> <tr> <th>Rated voltage</th> <th>Test voltage</th> </tr> </thead> <tbody> <tr> <td>DC250V</td> <td>150% of the rated voltage</td> </tr> <tr> <td>DC500V, DC630V</td> <td>120% of the rated voltage</td> </tr> <tr> <td>DC1kV</td> <td>110% of the rated voltage</td> </tr> </tbody> </table> <ul style="list-style-type: none"> Pretreatment Apply test voltage for one hour at test temperature. Remove and set at *room condition for 24 \pm 2 hours.	Rated voltage	Test voltage	DC250V	150% of the rated voltage	DC500V, DC630V	120% of the rated voltage	DC1kV	110% of the rated voltage
Rated voltage	Test voltage										
DC250V	150% of the rated voltage										
DC500V, DC630V	120% of the rated voltage										
DC1kV	110% of the rated voltage										
16	Solvent Resistance	Appearance	The capacitor should be fully immersed, unagitated, in reagent at 20 to 25 $^{\circ}\text{C}$ for 30 \pm 5 seconds. and then remove gently. Marking on the surface of the capacitor shall immediately be visually examined. Regent : Isopropyl alcohol								
		Marking									
		No defects or abnormalities. Legible.									

* "room condition" Temperature : 15 to 35 $^{\circ}\text{C}$, Relative humidity : 45 to 75%, Atmosphere pressure : 86 to 106kPa

6. Packing specification

• Bulk type (Packing style code : B)

The size of packing case and packing way

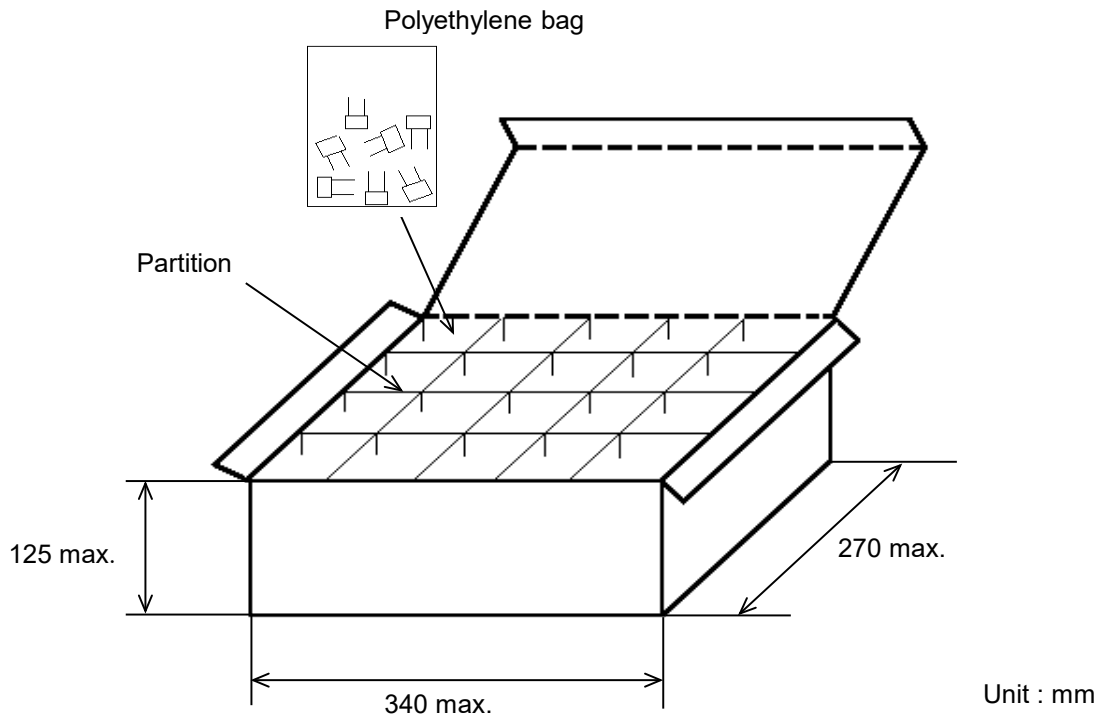

The number of packing = ^{*1} Packing quantity × ^{*2} n

*1 : Please refer to [Part number list].

*2 : Standard n = 20 (bag)

Note)

The outer package and the number of outer packing be changed by the order getting amount.

• Ammo pack taping type (Packing style code : A)

A crease is made every 25 pitches, and the tape with capacitors is packed zigzag into a case. When body of the capacitor is piled on other body under it.

The size of packing case and packing way

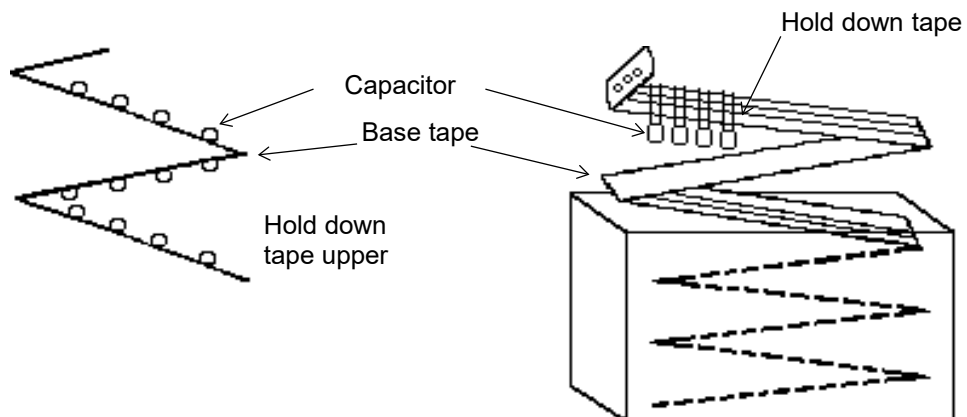
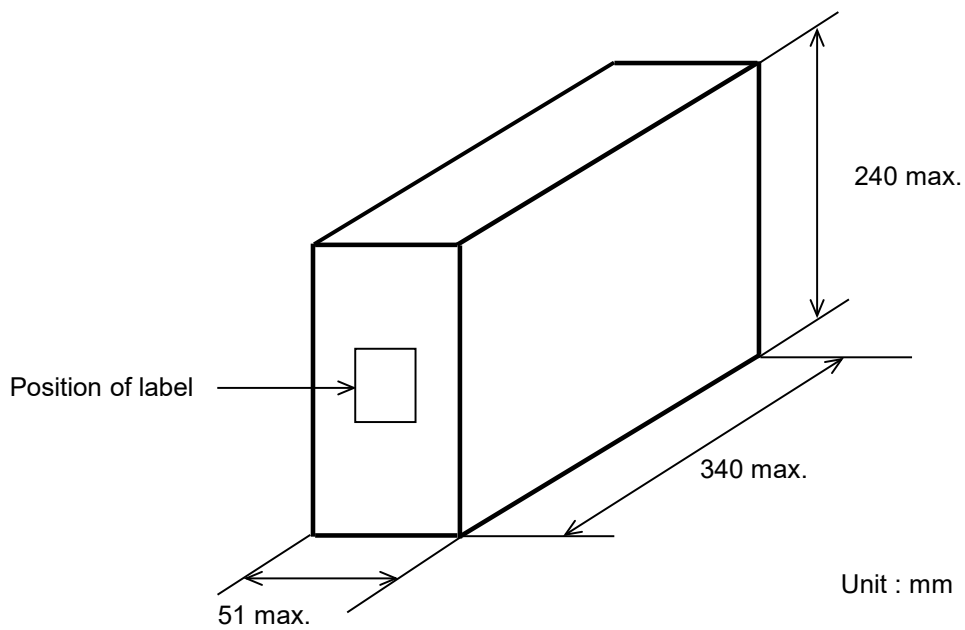

7. Taping specification

7-1. Dimension of capacitors on tape

Straight taping type < Lead Style : E1 >

Pitch of component 12.7mm / Lead spacing 5.0mm

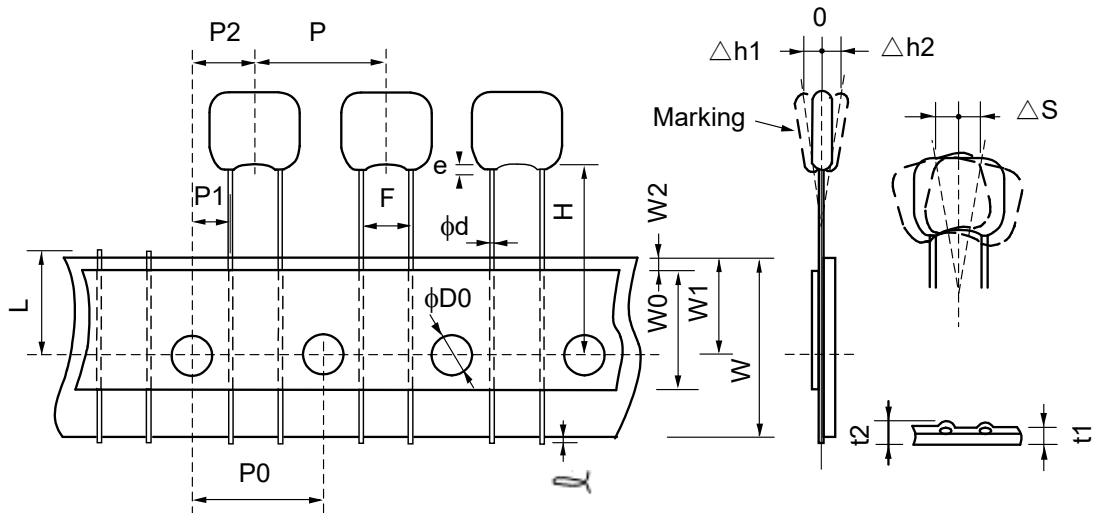

Unit : mm

Item	Code	Dimensions	Remarks
Pitch of component	P	12.7+/-1.0	
Pitch of sprocket hole	P0	12.7+/-0.2	
Lead spacing	F	5.0+0.6/-0.2	
Length from hole center to component center	P2	6.35+/-1.3	Deviation of progress direction
Length from hole center to lead	P1	3.85+/-0.7	
Deviation along tape, left or right defect	ΔS	0+/-2.0	They include deviation by lead bend
Carrier tape width	W	18.0+/-0.5	
Position of sprocket hole	W1	9.0+0/-0.5	Deviation of tape width direction
For straight lead type	H	17.5+/-0.5	
Protrusion length	ℓ	0.5 max.	
Diameter of sprocket hole	ΦD0	4.0+/-0.1	
Lead diameter	Φd	0.5+/-0.05	
Total tape thickness	t1	0.6+/-0.3	They include hold down tape thickness.
Total thickness of tape and lead wire	t2	1.5 max.	
Deviation across tape	Δh1	2.0 max. (Dimension code : U)	
	Δh2	1.0 max. (except as above)	
Portion to cut in case of defect	L	11.0+0/-1.0	
Hold down tape width	W0	9.5 min.	
Hold down tape position	W2	1.5+/-1.5	
Coating extension on lead	e	2.0 max. (Dimension code : U)	
		1.5 max. (except as above)	

Inside crimp taping type < Lead Style : M1 >

Pitch of component 12.7mm / Lead spacing 5.0mm

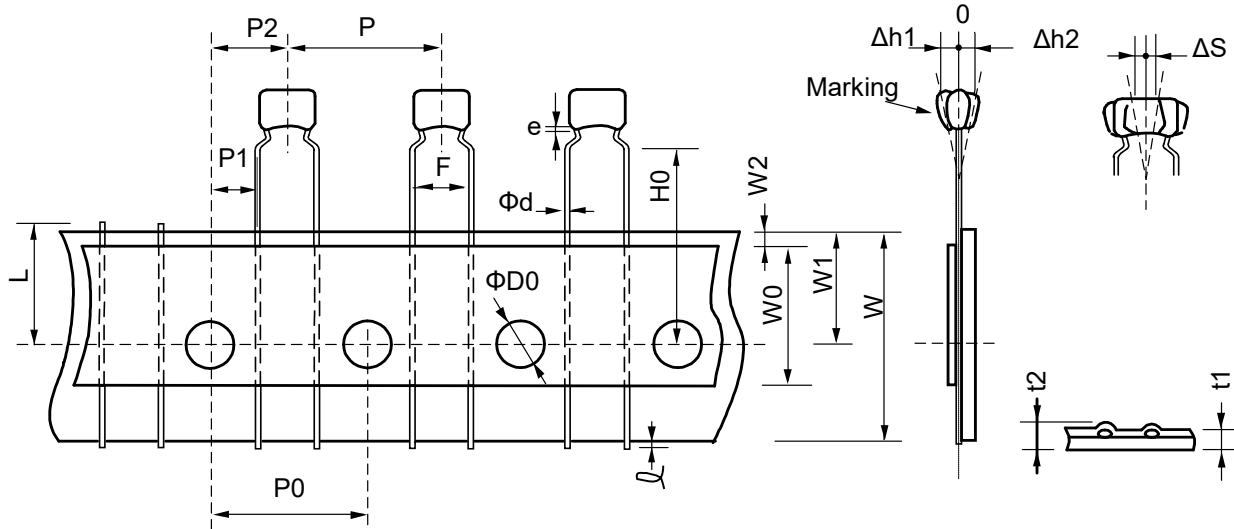

Unit : mm

Item	Code	Dimensions	Remarks
Pitch of component	P	12.7+/-1.0	
Pitch of sprocket hole	P0	12.7+/-0.2	
Lead spacing	F	5.0+0.6/-0.2	
Length from hole center to component center	P2	6.35+/-1.3	Deviation of progress direction
Length from hole center to lead	P1	3.85+/-0.7	
Deviation along tape, left or right defect	ΔS	0+/-2.0	They include deviation by lead bend
Carrier tape width	W	18.0+/-0.5	
Position of sprocket hole	W1	9.0+0/-0.5	Deviation of tape width direction
Lead distance between reference and bottom plane	H0	16.0+/-0.5	
Protrusion length	ℓ	0.5 max.	
Diameter of sprocket hole	ΦD0	4.0+/-0.1	
Lead diameter	Φd	0.5+/-0.05	
Total tape thickness	t1	0.6+/-0.3	They include hold down tape thickness
Total thickness of tape and lead wire	t2	1.5 max.	
Deviation across tape	Δh1	2.0 max. (Dimension code : W)	
	Δh2	1.0 max. (except as above)	
Portion to cut in case of defect	L	11.0+0/-1.0	
Hold down tape width	W0	9.5 min.	
Hold down tape position	W2	1.5+/-1.5	
Coating extension on lead	e	Up to the end of crimp	

7-2. Splicing way of tape

1) Adhesive force of tape is over 3N at test condition as below.

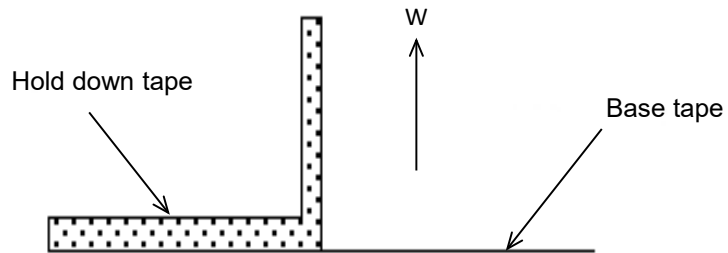

2) Splicing of tape

a) When base tape is spliced

- Base tape shall be spliced by cellophane tape.
(Total tape thickness shall be less than 1.05mm.)

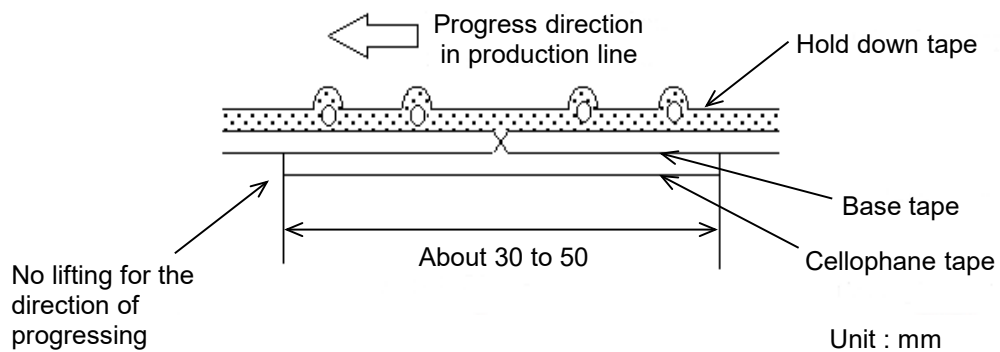

b) When hold down tape is spliced

- Hold down tape shall be spliced with overlapping.
(Total tape thickness shall be less than 1.05mm.)

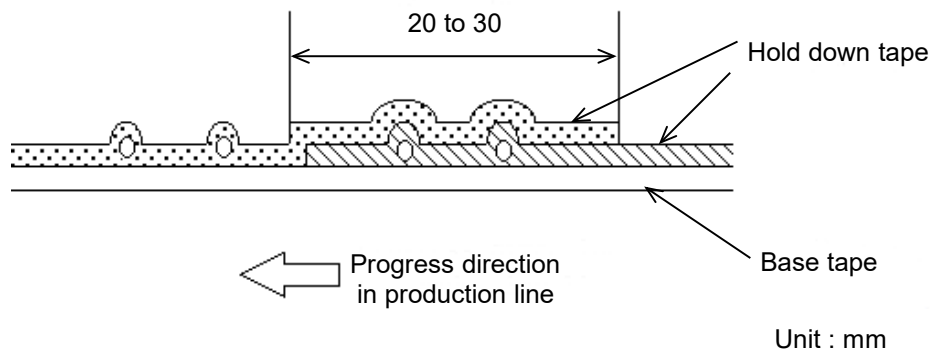

c) When both tape are spliced

- Base tape and hold down tape shall be spliced with splicing tape.

Mouser Electronics

Authorized Distributor

Click to View Pricing, Inventory, Delivery & Lifecycle Information:

Murata:

[RDER72E103K1M1H03A](#) [RDER72E152K1M1H03A](#) [RDER72E473K2M1H03A](#) [RDER72J104K4M1H03A](#)
[RDER72J153K2M1H03A](#) [RDER72J472K2M1H03A](#) [RDER72J683K4M1H03A](#) [RDER73A473K4M1H03A](#)
[RDER72E224K3M1H03A](#) [RDER72J102K2M1H03A](#) [RDER72J152K2M1H03A](#) [RDER72J474MUE1H03A](#)
[RDER72J682K2M1H03A](#) [RDER73A332K2M1H03A](#) [RDER73A472K2M1H03A](#) [RDER72E104K2M1H03A](#)
[RDER72E154K3M1H03A](#) [RDER72E332K1M1H03A](#) [RDER72E333K2M1H03A](#) [RDER72E474K4M1H03A](#)
[RDER72E682K1M1H03A](#) [RDER72J103K2M1H03A](#) [RDER72J332K2M1H03A](#) [RDER73A153K3M1H03A](#)
[RDER73A471K2M1H03A](#) [RDER73A681K2M1H03A](#) [RDER72E102K1M1H03A](#) [RDER72E222K1M1H03A](#)
[RDER72E472K1M1H03A](#) [RDER72E683K2M1H03A](#) [RDER72J222K2M1H03A](#) [RDER73A104K5E1H03A](#)
[RDER73A224MUE1H03A](#) [RDER72E334K4M1H03A](#) [RDER72J154K5E1H03A](#) [RDER72J224K5E1H03A](#)
[RDER72J333K3M1H03A](#) [RDER72J473K3M1H03A](#) [RDER73A102K2M1H03A](#) [RDER73A152K2M1H03A](#)
[RDER73A222K2M1H03A](#) [RDER73A223K3M1H03A](#) [RDER73A333K4M1H03A](#) [RDER73A683K5E1H03A](#)
[RDER72E103K1K1H03B](#) [RDER72J154K5B1H03B](#) [RDER73A152K2K1H03B](#) [RDER73A332K2K1H03B](#)
[RDER72J103K2K1H03B](#) [RDER72J222K2K1H03B](#) [RDER73A223K3K1H03B](#) [RDER72J472K2K1H03B](#)
[RDER73A472K2K1H03B](#) [RDER72E334K4K1H03B](#) [RDER72J104K4K1H03B](#) [RDER73A471K2K1H03B](#)
[RDER73A473K4K1H03B](#) [RDER72E682K1K1H03B](#) [RDER72E104K2K1H03B](#) [RDER72E472K1K1H03B](#)
[RDER72J102K2K1H03B](#) [RDER72E473K2K1H03B](#) [RDER73A153K3K1H03B](#) [RDER72J152K2K1H03B](#)
[RDER72J332K2K1H03B](#) [RDER73A104K5B1H03B](#) [RDER73A681K2K1H03B](#) [RDER73A683K5B1H03B](#)
[RDER72E332K1K1H03B](#) [RDER72E222K1K1H03B](#) [RDER72E152K1K1H03B](#) [RDER72E474K4K1H03B](#)
[RDER72J473K3K1H03B](#) [RDER72J224K5B1H03B](#) [RDER72J153K2K1H03B](#) [RDER72E154K3K1H03B](#)
[RDER73A333K4K1H03B](#) [RDER72E102K1K1H03B](#) [RDER73A102K2K1H03B](#) [RDER72E333K2K1H03B](#)
[RDER72E683K2K1H03B](#) [RDER72E224K3K1H03B](#) [RDER72J683K4K1H03B](#) [RDER72J474MUB1H03B](#)
[RDER72J682K2K1H03B](#) [RDER73A222K2K1H03B](#) [RDER73A224MUB1H03B](#) [RDER72J333K3K1H03B](#)
[RDER72H102K1K1H03B](#) [RDER72E223K1K1H03B](#) [RDER72H684MUE1H03A](#) [RDER72H103K1K1H03B](#)
[RDER72H473K2K1H03B](#) [RDER72H152K1K1H03B](#) [RDER72H332K1K1H03B](#) [RDER73A682K2M1H03A](#)
[RDER72H333K2M1H03A](#) [RDER72E153K1M1H03A](#) [RDER72H102K1M1H03A](#) [RDER73A103K2M1H03A](#)