

**CHIP COILS (CHIP INDUCTORS) LQP03TN□□□□Z2□**  
**Murata Standard REFERENCE SPECIFICATION [AEC-Q200]**

**1. Scope**

This reference specification applies to chip coils (chip inductors) LQP03TN\_Z2 series for automotive electronics based on AEC-Q200 except for power trains and safeties.

**2. Part Numbering**

(Ex.) LQ	P	03	T	N	0N6	B	Z	2	D
Product ID	Structure	Dimension (L × W)	Application and characteristic	Category	Inductance	Tolerance	Performance	Electrode specification	Packaging D: taping *B: bulk

\*B: Bulk packing is also available (taping condition: however, products without reels are put in plastic bags).

**3. Part Number and Rating**

Operating temperature range	-55°C to +125°C
Storage temperature range	-55°C to +125°C

Customer Part number	Murata Part number	Inductance		Q (Min.)	DC resistance (Ω max.)	Self-resonant frequency (MHz)		Rated current (mA)	ESD Rank 1C: 1kV
		Nominal value (nH)	Tolerance			Lower limit	*Typical value		
	LQP03TN0N6BZ2D	0.6	B: ±0.1 nH	14	0.07	20000	20000	850	1C
	LQP03TN0N6CZ2D	0.6	C: ±0.2 nH	14	0.07	20000	20000	850	1C
	LQP03TN0N7BZ2D	0.7	B: ±0.1 nH	14	0.08	20000	20000	800	1C
	LQP03TN0N7CZ2D	0.7	C: ±0.2 nH	14	0.08	20000	20000	800	1C
	LQP03TN0N8BZ2D	0.8	B: ±0.1 nH	14	0.08	18000	20000	800	1C
	LQP03TN0N8CZ2D	0.8	C: ±0.2 nH	14	0.08	18000	20000	800	1C
	LQP03TN0N9BZ2D	0.9	B: ±0.1 nH	14	0.10	18000	20000	750	1C
	LQP03TN0N9CZ2D	0.9	C: ±0.2 nH	14	0.10	18000	20000	750	1C
	LQP03TN1N0BZ2D	1.0	B: ±0.1 nH	14	0.10	17000	20000	750	1C
	LQP03TN1N0CZ2D	1.0	C: ±0.2 nH	14	0.10	17000	20000	750	1C
	LQP03TN1N1BZ2D	1.1	B: ±0.1 nH	14	0.10	17000	20000	750	1C
	LQP03TN1N1CZ2D	1.1	C: ±0.2 nH	14	0.10	17000	20000	750	1C
	LQP03TN1N2BZ2D	1.2	B: ±0.1 nH	14	0.10	17000	20000	750	1C
	LQP03TN1N2CZ2D	1.2	C: ±0.2 nH	14	0.10	17000	20000	750	1C
	LQP03TN1N3BZ2D	1.3	B: ±0.1 nH	14	0.15	17000	20000	600	1C
	LQP03TN1N3CZ2D	1.3	C: ±0.2 nH	14	0.15	17000	20000	600	1C
	LQP03TN1N4BZ2D	1.4	B: ±0.1 nH	14	0.15	16000	19600	600	1C
	LQP03TN1N4CZ2D	1.4	C: ±0.2 nH	14	0.15	16000	19600	600	1C
	LQP03TN1N5BZ2D	1.5	B: ±0.1 nH	14	0.15	15000	17900	600	1C
	LQP03TN1N5CZ2D	1.5	C: ±0.2 nH	14	0.15	15000	17900	600	1C
	LQP03TN1N6BZ2D	1.6	B: ±0.1 nH	14	0.15	15000	20000	600	1C
	LQP03TN1N6CZ2D	1.6	C: ±0.2 nH	14	0.15	15000	20000	600	1C
	LQP03TN1N7BZ2D	1.7	B: ±0.1 nH	14	0.15	15000	19100	600	1C
	LQP03TN1N7CZ2D	1.7	C: ±0.2 nH	14	0.15	15000	19100	600	1C
	LQP03TN1N8BZ2D	1.8	B: ±0.1 nH	14	0.15	15000	17700	600	1C
	LQP03TN1N8CZ2D	1.8	C: ±0.2 nH	14	0.15	15000	17700	600	1C
	LQP03TN1N9BZ2D	1.9	B: ±0.1 nH	14	0.15	12500	15100	600	1C

**Reference Only**

Customer Part number	Murata Part number	Inductance		Q (Min.)	DC resistance ( $\Omega$ max.)	Self-resonant frequency (MHz)		Rated current (mA)	ESD Rank 1C: 1kV
		Nominal value (nH)	Tolerance			Lower limit	*Typical value		
	LQP03TN1N9CZ2D	1.9	C: $\pm 0.2$ nH	14	0.15	12500	15100	600	1C
	LQP03TN2N0BZ2D	2.0	B: $\pm 0.1$ nH	14	0.15	12500	14800	600	1C
	LQP03TN2N0CZ2D	2.0	C: $\pm 0.2$ nH	14	0.15	12500	14800	600	1C
	LQP03TN2N1BZ2D	2.1	B: $\pm 0.1$ nH	14	0.15	11000	13900	600	1C
	LQP03TN2N1CZ2D	2.1	C: $\pm 0.2$ nH	14	0.15	11000	13900	600	1C
	LQP03TN2N2BZ2D	2.2	B: $\pm 0.1$ nH	14	0.15	11000	13400	600	1C
	LQP03TN2N2CZ2D	2.2	C: $\pm 0.2$ nH	14	0.15	11000	13400	600	1C
	LQP03TN2N3BZ2D	2.3	B: $\pm 0.1$ nH	14	0.20	10000	12900	500	1C
	LQP03TN2N3CZ2D	2.3	C: $\pm 0.2$ nH	14	0.20	10000	12900	500	1C
	LQP03TN2N4BZ2D	2.4	B: $\pm 0.1$ nH	14	0.20	10000	12200	500	1C
	LQP03TN2N4CZ2D	2.4	C: $\pm 0.2$ nH	14	0.20	10000	12200	500	1C
	LQP03TN2N5BZ2D	2.5	B: $\pm 0.1$ nH	14	0.20	10000	12200	500	1C
	LQP03TN2N5CZ2D	2.5	C: $\pm 0.2$ nH	14	0.20	10000	12200	500	1C
	LQP03TN2N6BZ2D	2.6	B: $\pm 0.1$ nH	14	0.20	10000	13300	500	1C
	LQP03TN2N6CZ2D	2.6	C: $\pm 0.2$ nH	14	0.20	10000	13300	500	1C
	LQP03TN2N7BZ2D	2.7	B: $\pm 0.1$ nH	14	0.20	10000	13000	500	1C
	LQP03TN2N7CZ2D	2.7	C: $\pm 0.2$ nH	14	0.20	10000	13000	500	1C
	LQP03TN2N8BZ2D	2.8	B: $\pm 0.1$ nH	14	0.20	9500	11800	500	1C
	LQP03TN2N8CZ2D	2.8	C: $\pm 0.2$ nH	14	0.20	9500	11800	500	1C
	LQP03TN2N9BZ2D	2.9	B: $\pm 0.1$ nH	14	0.20	9500	12400	500	1C
	LQP03TN2N9CZ2D	2.9	C: $\pm 0.2$ nH	14	0.20	9500	12400	500	1C
	LQP03TN3N0BZ2D	3.0	B: $\pm 0.1$ nH	14	0.25	9500	11900	450	1C
	LQP03TN3N0CZ2D	3.0	C: $\pm 0.2$ nH	14	0.25	9500	11900	450	1C
	LQP03TN3N1BZ2D	3.1	B: $\pm 0.1$ nH	14	0.25	8000	11300	450	1C
	LQP03TN3N1CZ2D	3.1	C: $\pm 0.2$ nH	14	0.25	8000	11300	450	1C
	LQP03TN3N2BZ2D	3.2	B: $\pm 0.1$ nH	14	0.25	8000	10600	450	1C
	LQP03TN3N2CZ2D	3.2	C: $\pm 0.2$ nH	14	0.25	8000	10600	450	1C
	LQP03TN3N3BZ2D	3.3	B: $\pm 0.1$ nH	14	0.25	8000	10900	450	1C
	LQP03TN3N3CZ2D	3.3	C: $\pm 0.2$ nH	14	0.25	8000	10900	450	1C
	LQP03TN3N4BZ2D	3.4	B: $\pm 0.1$ nH	14	0.25	7000	9400	450	1C
	LQP03TN3N4CZ2D	3.4	C: $\pm 0.2$ nH	14	0.25	7000	9400	450	1C
	LQP03TN3N5BZ2D	3.5	B: $\pm 0.1$ nH	14	0.25	7000	9600	450	1C
	LQP03TN3N5CZ2D	3.5	C: $\pm 0.2$ nH	14	0.25	7000	9600	450	1C
	LQP03TN3N6BZ2D	3.6	B: $\pm 0.1$ nH	14	0.30	6000	9500	400	1C
	LQP03TN3N6CZ2D	3.6	C: $\pm 0.2$ nH	14	0.30	6000	9500	400	1C
	LQP03TN3N7BZ2D	3.7	B: $\pm 0.1$ nH	14	0.30	6000	8200	400	1C
	LQP03TN3N7CZ2D	3.7	C: $\pm 0.2$ nH	14	0.30	6000	8200	400	1C
	LQP03TN3N8BZ2D	3.8	B: $\pm 0.1$ nH	14	0.30	6000	8100	400	1C
	LQP03TN3N8CZ2D	3.8	C: $\pm 0.2$ nH	14	0.30	6000	8100	400	1C
	LQP03TN3N9BZ2D	3.9	B: $\pm 0.1$ nH	14	0.30	5700	7900	400	1C
	LQP03TN3N9CZ2D	3.9	C: $\pm 0.2$ nH	14	0.30	5700	7900	400	1C
	LQP03TN4N0BZ2D	4.0	B: $\pm 0.1$ nH	14	0.40	5300	8600	350	1C
	LQP03TN4N0CZ2D	4.0	C: $\pm 0.2$ nH	14	0.40	5300	8600	350	1C
	LQP03TN4N1BZ2D	4.1	B: $\pm 0.1$ nH	14	0.40	5300	8400	350	1C

Customer Part number	Murata Part number	Inductance		Q (Min.)	DC resistance ( $\Omega$ max.)	Self-resonant frequency (MHz)		Rated current (mA)	ESD Rank 1C: 1kV
		Nominal value (nH)	Tolerance			Lower limit	*Typical value		
	LQP03TN4N1CZ2D	4.1	C: $\pm 0.2$ nH	14	0.40	5300	8400	350	1C
	LQP03TN4N2BZ2D	4.2	B: $\pm 0.1$ nH	14	0.40	5300	8600	350	1C
	LQP03TN4N2CZ2D	4.2	C: $\pm 0.2$ nH	14	0.40	5300	8600	350	1C
	LQP03TN4N3HZ2D	4.3	H: $\pm 3\%$	14	0.40	5300	9800	350	1C
	LQP03TN4N3JZ2D	4.3	J: $\pm 5\%$	14	0.40	5300	9800	350	1C
	LQP03TN4N7HZ2D	4.7	H: $\pm 3\%$	14	0.40	4400	8800	350	1C
	LQP03TN4N7JZ2D	4.7	J: $\pm 5\%$	14	0.40	4400	8800	350	1C
	LQP03TN5N1HZ2D	5.1	H: $\pm 3\%$	14	0.40	4200	8600	350	1C
	LQP03TN5N1JZ2D	5.1	J: $\pm 5\%$	14	0.40	4200	8600	350	1C
	LQP03TN5N6HZ2D	5.6	H: $\pm 3\%$	14	0.40	4000	8000	350	1C
	LQP03TN5N6JZ2D	5.6	J: $\pm 5\%$	14	0.40	4000	8000	350	1C
	LQP03TN6N2HZ2D	6.2	H: $\pm 3\%$	14	0.60	4000	7900	300	1C
	LQP03TN6N2JZ2D	6.2	J: $\pm 5\%$	14	0.60	4000	7900	300	1C
	LQP03TN6N8HZ2D	6.8	H: $\pm 3\%$	14	0.60	3900	8000	300	1C
	LQP03TN6N8JZ2D	6.8	J: $\pm 5\%$	14	0.60	3900	8000	300	1C
	LQP03TN7N5HZ2D	7.5	H: $\pm 3\%$	14	0.60	3700	6700	300	1C
	LQP03TN7N5JZ2D	7.5	J: $\pm 5\%$	14	0.60	3700	6700	300	1C
	LQP03TN8N2HZ2D	8.2	H: $\pm 3\%$	14	0.70	3600	6600	250	1C
	LQP03TN8N2JZ2D	8.2	J: $\pm 5\%$	14	0.70	3600	6600	250	1C
	LQP03TN9N1HZ2D	9.1	H: $\pm 3\%$	14	0.70	3300	5900	250	1C
	LQP03TN9N1JZ2D	9.1	J: $\pm 5\%$	14	0.70	3300	5900	250	1C
	LQP03TN10NHZ2D	10	H: $\pm 3\%$	14	0.70	3200	5800	250	1C
	LQP03TN10NJZ2D	10	J: $\pm 5\%$	14	0.70	3200	5800	250	1C
	LQP03TN11NHZ2D	11	H: $\pm 3\%$	14	0.80	2900	5400	250	1C
	LQP03TN11NJZ2D	11	J: $\pm 5\%$	14	0.80	2900	5400	250	1C
	LQP03TN12NHZ2D	12	H: $\pm 3\%$	12	0.70	2900	4300	250	1C
	LQP03TN12NJZ2D	12	J: $\pm 5\%$	12	0.70	2900	4300	250	1C
	LQP03TN13NHZ2D	13	H: $\pm 3\%$	12	0.80	2600	4300	250	1C
	LQP03TN13NJZ2D	13	J: $\pm 5\%$	12	0.80	2600	4300	250	1C
	LQP03TN15NHZ2D	15	H: $\pm 3\%$	12	0.70	2600	3800	250	1C
	LQP03TN15NJZ2D	15	J: $\pm 5\%$	12	0.70	2600	3800	250	1C
	LQP03TN16NHZ2D	16	H: $\pm 3\%$	12	0.95	2200	3700	200	1C
	LQP03TN16NJZ2D	16	J: $\pm 5\%$	12	0.95	2200	3700	200	1C
	LQP03TN18NHZ2D	18	H: $\pm 3\%$	12	0.80	2200	3400	200	1C
	LQP03TN18NJZ2D	18	J: $\pm 5\%$	12	0.80	2200	3400	200	1C
	LQP03TN20NHZ2D	20	H: $\pm 3\%$	12	2.30	2200	3600	150	1C
	LQP03TN20NJZ2D	20	J: $\pm 5\%$	12	2.30	2200	3600	150	1C
	LQP03TN22NHZ2D	22	H: $\pm 3\%$	12	1.90	2200	3300	150	1C
	LQP03TN22NJZ2D	22	J: $\pm 5\%$	12	1.90	2200	3300	150	1C
	LQP03TN24NHZ2D	24	H: $\pm 3\%$	12	2.30	2000	3200	140	1C
	LQP03TN24NJZ2D	24	J: $\pm 5\%$	12	2.30	2000	3200	140	1C
	LQP03TN27NHZ2D	27	H: $\pm 3\%$	12	2.30	2000	2900	140	1C
	LQP03TN27NJZ2D	27	J: $\pm 5\%$	12	2.30	2000	2900	140	1C
	LQP03TN30NHZ2D	30	H: $\pm 3\%$	9	2.95	1700	2700	120	1C

Customer Part number	Murata Part number	Inductance		Q (Min.)	DC resistance ( $\Omega$ max.)	Self-resonant frequency (MHz)		Rated current (mA)	ESD Rank 1C: 1kV
		Nominal value (nH)	Tolerance			Lower limit	*Typical value		
	LQP03TN30NJZ2D	30	J: $\pm 5\%$	9	2.95	1700	2700	120	1C
	LQP03TN33NHZ2D	33	H: $\pm 3\%$	9	2.95	1700	2600	120	1C
	LQP03TN33NJZ2D	33	J: $\pm 5\%$	9	2.95	1700	2600	120	1C
	LQP03TN36NHZ2D	36	H: $\pm 3\%$	9	3.00	1500	2400	120	1C
	LQP03TN36NJZ2D	36	J: $\pm 5\%$	9	3.00	1500	2400	120	1C
	LQP03TN39NHZ2D	39	H: $\pm 3\%$	9	3.00	1500	2200	120	1C
	LQP03TN39NJZ2D	39	J: $\pm 5\%$	9	3.00	1500	2200	120	1C
	LQP03TN43NHZ2D	43	H: $\pm 3\%$	9	3.60	1300	2200	100	1C
	LQP03TN43NJZ2D	43	J: $\pm 5\%$	9	3.60	1300	2200	100	1C
	LQP03TN47NHZ2D	47	H: $\pm 3\%$	9	3.60	1300	2000	100	1C
	LQP03TN47NJZ2D	47	J: $\pm 5\%$	9	3.60	1300	2000	100	1C
	LQP03TN51NHZ2D	51	H: $\pm 3\%$	9	3.90	1200	2000	100	1C
	LQP03TN51NJZ2D	51	J: $\pm 5\%$	9	3.90	1200	2000	100	1C
	LQP03TN56NHZ2D	56	H: $\pm 3\%$	9	3.90	1200	2000	100	1C
	LQP03TN56NJZ2D	56	J: $\pm 5\%$	9	3.90	1200	2000	100	1C
	LQP03TN62NHZ2D	62	H: $\pm 3\%$	8	8	1100	1800	100	1C
	LQP03TN62NJZ2D	62	J: $\pm 5\%$	8	8	1100	1800	100	1C
	LQP03TN68NHZ2D	68	H: $\pm 3\%$	8	8	1100	1500	100	1C
	LQP03TN68NJZ2D	68	J: $\pm 5\%$	8	8	1100	1500	100	1C
	LQP03TN75NJZ2D	75	H: $\pm 3\%$	8	10	1000	1400	100	1C
	LQP03TN75NHZ2D	75	J: $\pm 5\%$	8	10	1000	1400	100	1C
	LQP03TN82NHZ2D	82	H: $\pm 3\%$	8	10	1000	1400	100	1C
	LQP03TN82NJZ2D	82	J: $\pm 5\%$	8	10	1000	1400	100	1C
	LQP03TN91NHZ2D	91	H: $\pm 3\%$	8	10	900	1300	80	1C
	LQP03TN91NJZ2D	91	J: $\pm 5\%$	8	10	900	1300	80	1C
	LQP03TNR10HZ2D	100	H: $\pm 3\%$	8	10	900	1300	80	1C
	LQP03TNR10JZ2D	100	J: $\pm 5\%$	8	10	900	1300	80	1C
	LQP03TNR11HZ2D	110	H: $\pm 3\%$	8	12	800	1100	80	1C
	LQP03TNR11JZ2D	110	J: $\pm 5\%$	8	12	800	1100	80	1C
	LQP03TNR12HZ2D	120	H: $\pm 3\%$	8	12	800	1100	80	1C
	LQP03TNR12JZ2D	120	J: $\pm 5\%$	8	12	800	1100	80	1C

\* Typical value is actual performance.

**4. Testing Conditions**

Unless otherwise specified	Temperature: ordinary temperature (15°C to 35°C) Humidity: ordinary humidity [25% to 85% (RH)]
In case of doubt	Temperature: 20°C $\pm$ 2°C Humidity: 60% to 70% (RH) Atmospheric pressure: 86 kPa to 106 kPa

**5. Appearance and Dimensions**

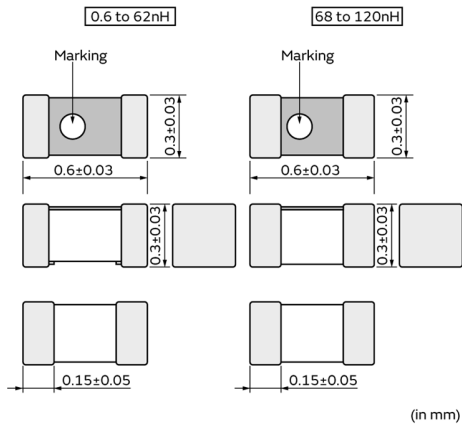

Unit mass (typical value): 0.2 mg

**6. Marking**

Direction identification marking: white

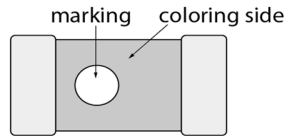

**7. Electrical Performance**

No.	Item	Specification	Test method				
7.1	Inductance	Meet chapter 3 ratings.	Measuring equipment: Keysight E4991A or the equivalent Measuring frequency: <table border="1" style="margin-left: 20px;"> <tr> <td>500 MHz</td> <td>0.6 nH to 30 nH</td> </tr> <tr> <td>300 MHz</td> <td>33 nH to 120 nH</td> </tr> </table> Measuring conditions: Measurement signal level: Approx. 0 dBm Measurement terminal distance: 0.2 mm Electrical length: 10 mm Weight: Approx. 1 N to 5 N Measuring fixture: Keysight 16197A Position the chip coil under test as shown in the measuring example below and connect it to the electrode by applying weight. Measurement example: <div style="text-align: center;"> </div> Measuring method: see "Electrical performance: Measuring method for inductance/Q" in the Appendix.	500 MHz	0.6 nH to 30 nH	300 MHz	33 nH to 120 nH
500 MHz	0.6 nH to 30 nH						
300 MHz	33 nH to 120 nH						
7.2	Q	Meet chapter 3 ratings.					
7.3	DC resistance	Meet chapter 3 ratings.	Measuring equipment: digital multimeter				
7.4	Self-resonant frequency	Meet chapter 3 ratings.	Measuring equipment: Keysight N5230A or the equivalent				

No.	Item	Specification	Test method
7.5	Rated current	Product temperature rise: 25°C max.	Apply the rated current specified in chapter 3.

## 8. AEC-Q200 Requirement

### 8.1 Performance [based on table 5 for magnetics (inductors/transformer) AEC-Q200 Rev. D issued June 1, 2010]

AEC-Q200			Murata specification/deviation				
No.	Stress	Test method					
3	High temperature exposure	1000 h at 125°C Set for 24 h at room condition, then measured.	Meet table A after testing. Table A <table border="1"> <tr> <td>Appearance</td> <td>No damage</td> </tr> <tr> <td>Inductance change rate: 0.6 nH to 30 nH (at 500 MHz) 33 nH to 120 nH (at 300MHz)</td> <td>Within ±10%</td> </tr> </table> Substrate: 6-layers FR-4	Appearance	No damage	Inductance change rate: 0.6 nH to 30 nH (at 500 MHz) 33 nH to 120 nH (at 300MHz)	Within ±10%
Appearance	No damage						
Inductance change rate: 0.6 nH to 30 nH (at 500 MHz) 33 nH to 120 nH (at 300MHz)	Within ±10%						
4	Temperature cycling	1000 cycles -40°C to +125°C Set for 24 h at room condition, then measured.	Meet table A after testing. Substrate: 6-layers FR-4				
7	Biased humidity	1000 h at 85°C, 85% (RH). Unpowered. Set for 24 h at room condition, then measured.	Meet table A after testing. Substrate: 6-layers FR-4				
8	Operational life	Apply 125°C 1000 h Set for 24 h at room condition, then measured.	Meet table A after testing. Substrate: 6-layers FR-4				
9	External visual	Visual inspection	No abnormalities				
10	Physical dimension	Meet chapter 5, "Appearance and Dimensions".	No defects				
12	Resistance to solvents	Per MIL-STD-202 Method 215	Not applicable				
13	Mechanical shock	Per MIL-STD-202 Method 213 Condition F: 1500 g's (14.7 N), 0.5 ms, half sine	Meet table A after testing. Substrate: 6-layers FR-4				
14	Vibration	5 g's (0.049 N) for 20 min, 12 cycles each of 3 orientations Test from 10 Hz to 2000 Hz	Meet table A after testing. Substrate: 6-layers FR-4				
15	Resistance to soldering heat	No-heating Solder temperature 260°C±5°C Immersion time 10 s	Pre-heating: 150°C±10°C, 60 s to 90 s Meet table A after testing.				
17	ESD	Per AEC-Q200-002	ESD rank: Refer to chapter 3 ratings. Substrate: 6-layers FR-4				
18	Solderability	Per J-STD-002	Method b: not applicable Pre-heating: 150°C±10°C, 60 s to 90 s 90% of the terminations is to be soldered.				
19	Electrical characterization	Measured: inductance	No defects				
20	Flammability	Per UL-94	Not applicable				
21	Board flex	Epoxy-PCB (1.6 mm) Deflection 2 mm (min.) Holding time 60 s	Meet table B after testing. Murata deviation request: Substrate: FR-4 (0.8 mm thickness) Holding time: 30 s Table B <table border="1"> <tr> <td>Appearance</td> <td>No damage</td> </tr> <tr> <td>DC resistance change rate</td> <td>Within ±10%</td> </tr> </table>	Appearance	No damage	DC resistance change rate	Within ±10%
Appearance	No damage						
DC resistance change rate	Within ±10%						
22	Terminal strength	Per AEC-Q200-006 A force of 17.7 N for 60 s	Murata deviation request: 2 N for 5 s Substrate: 6-layers FR-4 No defects				

**9. Specification of Packaging**

**9.1 Appearance and dimensions of tape (8 mm width/paper tape)**

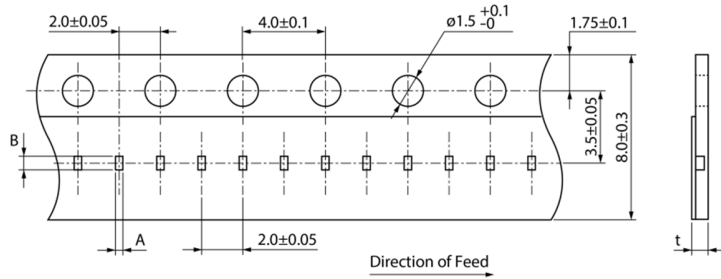

A	0.35±0.03
B	0N6 to 62N : 0.67±0.03 68N to R12 : 0.65±0.03
t	0.55 max.

(in mm)

■ Top view

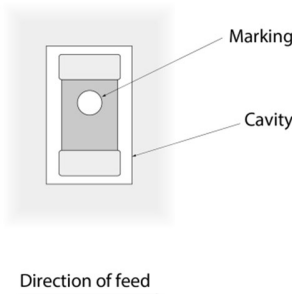

**9.2 Taping specifications**

Packing quantity (Standard quantity)	15000 pcs/reel
Packing method	The products are placed in cavities of a carrier tape and sealed by a cover tape (top tape and bottom tape when the cavities of the carrier tape are punched type).
Feed hole position	The feed holes on the carrier tape are on the right side when the cover tape (top tape when the cavities of the carrier tape are punched type) is pulled toward the user.
Joint	The carrier tape and cover tape (top tape when the cavities of the carrier tape are punched type) are seamless.
Number of missing products	Number of missing products within 0.1% of the number per reel or 1 pc., whichever is greater, and are not continuous. The specified quantity per reel is kept.

**9.3 Break down force of tape**

Cover tape (or top tape)	5 N min.
Bottom tape (only when the cavities of the carrier tape are punched type)	5 N min.

**9.4 Peeling off force of tape**

Speed of peeling off	300 mm/min
Peeling off force	0.1 N to 0.6 N (The lower limit is for typical value.)

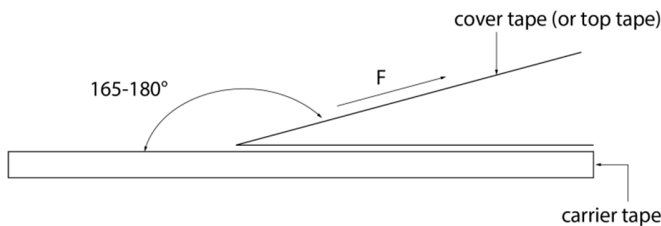

### 9.5 Dimensions of leader section, trailer section and reel

A vacant section is provided in the leader (start) section and trailer (end) section of the tape for the product. The leader section is further provided with an area consisting only of the cover tape (or top tape). (See the diagram below.)

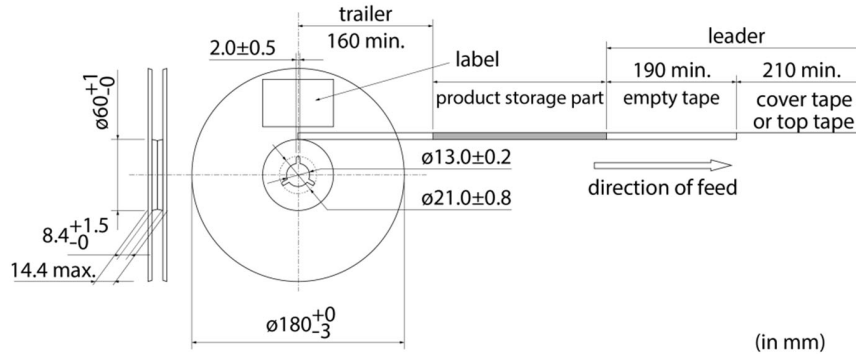

### 9.6 Marking for reel

Customer part number, Murata part number, inspection number (\*1), RoHS marking (\*2), quantity, etc.

<p>*1 Expression of inspection No.:</p> <table style="width: 100%; border-collapse: collapse;"> <tr> <td style="text-align: center; width: 33%;"><math>\square\square</math></td> <td style="text-align: center; width: 33%;"><math>\circ\circ\circ\circ</math></td> <td style="text-align: center; width: 33%;"><math>\diamond\diamond\diamond</math></td> </tr> <tr> <td style="text-align: center;">(1)</td> <td style="text-align: center;">(2)</td> <td style="text-align: center;">(3)</td> </tr> </table>	$\square\square$	$\circ\circ\circ\circ$	$\diamond\diamond\diamond$	(1)	(2)	(3)	<p>(1) Factory code (2) Date First digit: year/last digit of year Second digit: month/Jan. to Sep.→1 to 9, Oct. to Dec.→O, N, D Third, Fourth digit: day (3) Serial No.</p>
$\square\square$	$\circ\circ\circ\circ$	$\diamond\diamond\diamond$					
(1)	(2)	(3)					
<p>*2 Expression of RoHS marking:</p> <table style="width: 100%; border-collapse: collapse;"> <tr> <td style="text-align: center; width: 33%;">ROHS-</td> <td style="text-align: center; width: 33%;"><math>\frac{Y}{(1)}</math></td> <td style="text-align: center; width: 33%;"><math>\frac{(\Delta)}{(2)}</math></td> </tr> </table>	ROHS-	$\frac{Y}{(1)}$	$\frac{(\Delta)}{(2)}$	<p>(1) RoHS regulation conformity (2) Murata classification number</p>			
ROHS-	$\frac{Y}{(1)}$	$\frac{(\Delta)}{(2)}$					

### 9.7 Marking on outer box (corrugated box)

Customer name, purchasing order number, customer part number, Murata part number, RoHS marking (\*2), quantity, etc.

### 9.8 Specification of outer box

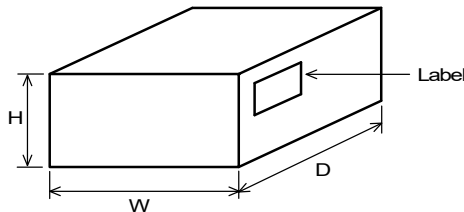

Dimensions of outer box (mm)			Standard reel quantity in outer box (reel)
W	D	H	
186	186	93	5
* Above outer box size is typical. It depends on a quantity of an order.			

## 10. ⚠Caution

### 10.1 Restricted applications

Please contact us before using our products for the applications listed below which require especially high reliability for the prevention of defects which might directly cause damage to the third party's life, body or property.

- |                               |   |                              |   |
|-------------------------------|---|------------------------------|---|
| (1) Aircraft equipment        | (2) Aerospace equipment   | (3) Undersea equipment       | (4) Power plant control equipment       |
| (5) Medical equipment         | (6) Transportation equipment (trains, ships, etc.)  | (7) Traffic signal equipment | (8) Disaster/crime prevention equipment |
| (9) Data-processing equipment | (10) Applications of similar complexity and/or reliability requirements to the applications listed in the above |                              |   |

### 10.2 Precautions on rating

Avoid using in exceeded the rated temperature range, rated voltage, or rated current. Usage when the ratings are exceeded could lead to wire breakage, burning, or other serious fault.



**10.3 Inrush current**

If an inrush current (or pulse current or rush current) that significantly exceeds the rated current is applied to the product, overheating could occur, resulting in wire breakage, burning, or other serious fault.

**10.4 Fail-safe**

Be sure to provide an appropriate fail-safe function on your product to prevent a second damage that may be caused by the abnormal function or the failure of our product.

**11. Precautions for Use**

This product is for use only with reflow soldering. It is designed to be mounted by soldering. If you want to use other mounting method, for example, using a conductive adhesive, please consult us beforehand.

Also, if repeatedly subjected to temperature cycles or other thermal stress, due to the difference in the coefficient of thermal expansion with the mounting substrate, the solder (solder fillet part) in the mounting part may crack.

The occurrence of cracks due to thermal stress is affected by the size of the land where mounted, the solder volume, and the heat dissipation of the mounting substrate. Carefully design it when a large change in ambient temperature is assumed.

**11.1. Land dimensions**

The following diagram shows the recommended land dimensions for reflow soldering:

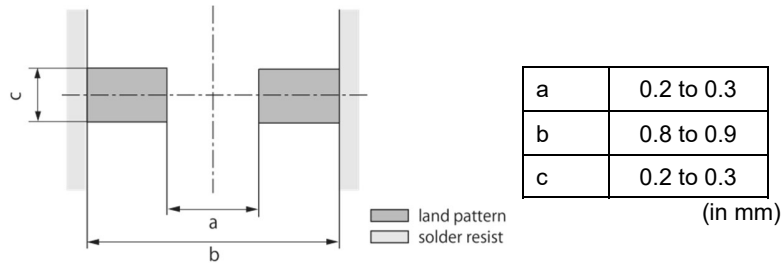
**11.2 Flux and solder used**

Flux	<ul style="list-style-type: none"> <li>• Use a rosin-based flux.</li> <li>• Do not use a highly acidic flux with a halide content exceeding 0.2(wt)% (chlorine conversion value).</li> <li>• Do not use a water-soluble flux.</li> </ul>
Solder	<ul style="list-style-type: none"> <li>• Use Sn-3.0Ag-0.5Cu solder.</li> <li>• Standard thickness of solder paste: 60 μm to 100 μm</li> </ul>

If you want to use a flux other than the above, please consult our technical department.

**11.3 Soldering conditions (reflow)**

- Pre-heating should be in such a way that the temperature difference between solder and product surface is limited to 150°C max.  
Insufficient pre-heating or sudden cooling may cause cracks or other defects on the ceramic body, resulting in the deterioration of product quality.
- Standard soldering profile and the limit soldering profile is as follows.  
The excessive limit soldering conditions may cause leaching of the electrode and/or resulting in the deterioration of product quality.

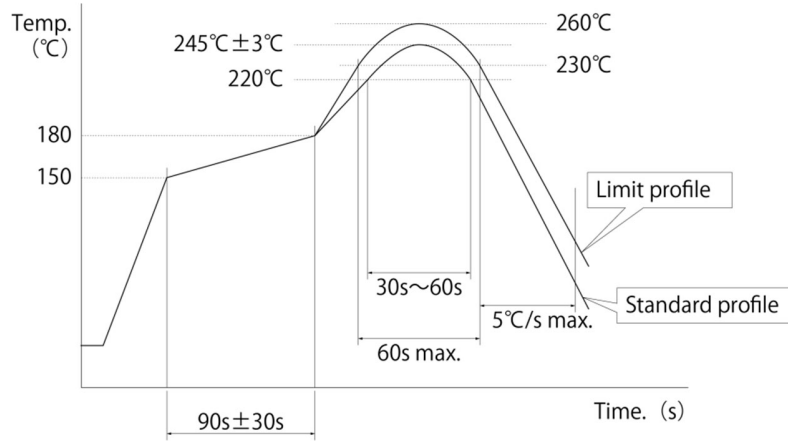

	Standard profile	Limit profile
Pre-heating	150°C to 180°C/90 s ± 30 s	150°C to 180°C/90 s ± 30 s
Heating	Above 220°C/30 s to 60 s	Above 230°C/60 s max.
Peak temperature	245°C ± 3°C	260°C/10 s
Number of reflow cycles	2 times	2 times
Cooling speed	5°C/sec max.	5°C/sec max.

**11.4 Reworking with soldering iron**

The following requirements must be met to rework a soldered product using a soldering iron.

Item	Requirement
Pre-heating	150°C/approx. 1 min
Tip temperature of soldering iron	350°C max.
Power consumption of soldering iron	80 W max.
Tip diameter of soldering iron	ø3 mm max.
Soldering time	3 s (+1 s, -0 s)
Number of reworking operations	2 times max.
* Avoid a direct contact of the tip of the soldering iron with the product. Such a direction contact may cause cracks in the ceramic body due to thermal shock.	

**11.5 Solder volume**

Solder shall be used not to be exceeded the upper limits as shown below.

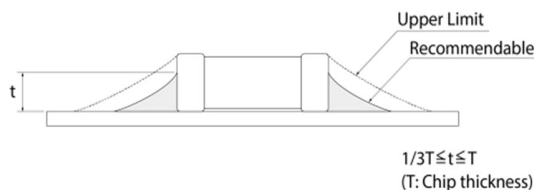

An increased solder volume increases mechanical stress on the product. Exceeding solder volume may cause the failure of mechanical or electrical performance.

**11.6 Product's location**

The following shall be considered when designing and laying out PCBs.

(1) PCB shall be designed so that products are not subject to mechanical stress due to warping the board.

[Products direction]

Products shall be located in the sideways direction (length:  $a < b$ ) to the mechanical stress.

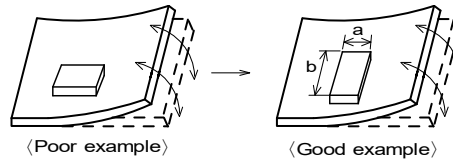

(2) Components location on PCB separation

It is effective to implement the following measures, to reduce stress in separating the board.

It is best to implement all of the following three measures; however, implement as many measures as possible to reduce stress.

Contents of measures	Stress level
(1) Turn the mounting direction of the component parallel to the board separation surface.	$A > D^{*1}$
(2) Add slits in the board separation part.	$A > B$
(3) Keep the mounting position of the component away from the board separation surface.	$A > C$
*1 $A > D$ is valid when stress is added vertically to the perforation as with hand separation. If a cutting disc is used, stress will be diagonal to the PCB, therefore $A > D$ is invalid.	

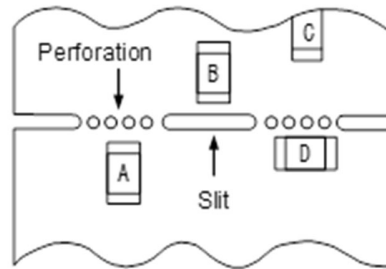

(3) Mounting components near screw holes

When a component is mounted near a screw hole, it may be affected by the board deflection that occurs during the tightening of the screw.

Mount the component in a position as far away from the screw holes as possible.

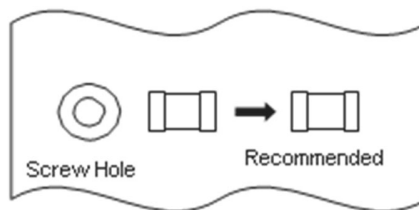

**11.7 Handling of substrate**

- Do not mount on a flexible substrate.
- Contact our technical department in advance if you want to use a multilayer substrate with less than six layers.
- \* When mounting on a flexible substrate or a multi-layered substrate with less than six layers, cracks may occur due to stress on the product.

(1) The stress applied to the chip varies depending on the material and construction of the mounted substrate. If the coefficients of thermal expansion for the substrate and chip vary significantly, the difference in thermal expansion and shrinkage could cause cracks to form in the chip.

We assume that the products are mounted on glass-epoxy substrate. Assessment has not been conducted on substrates where the coefficient of thermal expansion varies significantly from glass-epoxy substrates. Conduct a thorough assessment before mounting on these substrates.

(2) After mounting products on a substrate, do not apply any stress to the product caused by bending or twisting to the substrate when cropping the substrate, inserting and removing a connector from the substrate or tightening screw to the substrate.

Excessive mechanical stress may cause cracking in the product.

Also, if mounting on flexible substrates, excessive mechanical stress could be applied to the chip by even slight bending or twisting when handling this substrate, and so please conduct full assessments before use.

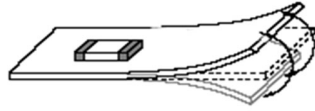

Bending

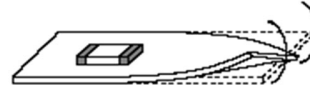

Twisting

### 11.8 Cleaning

The product shall be cleaned under the following conditions.

(1) The cleaning temperature shall be 60°C max. If isopropyl alcohol (IPA) is used, the cleaning temperature shall be 40°C max.

(2) Perform ultrasonic cleaning under the following conditions. Exercise caution to prevent resonance phenomenon in mounted products and the PCB.

Item	Requirement
Power	20 W/L max.
Time	5 min max.
Frequency	28 kHz to 40 kHz

(3) Cleaner

Alcohol-based cleaner: IPA

Aqueous agent: PINE ALPHA ST-100S

(4) There shall be no residual flux or residual cleaner. When using aqueous agent, rinse the product with deionized water adequately and completely dry it so that no cleaner is left.

\* For other cleaning, consult our technical department.

### 11.9 Storage and transportation

Storage period	Use the product within 12 months after delivery. If you do not use the product for more than 12 months, check solderability before using it.
Storage conditions	<ul style="list-style-type: none"> <li>The products shall be stored in a room not subject to rapid changes in temperature and humidity. The recommended temperature range is -10°C to +40°C. The recommended relative humidity range is 15% to 85%. Keeping the product in corrosive gases, such as sulfur, chlorine gas or acid may cause the poor solderability.</li> <li>Do not place the products directly on the floor; they should be placed on a palette so that they are not affected by humidity or dust.</li> <li>Avoid keeping the products in a place exposed to direct sunlight, heat or vibration.</li> <li>Do not keep products in bulk packaging. Bulk storage could result in collisions between the products or between the products and other parts, resulting in chipping or wire breakage.</li> <li>Avoid storing the product by itself bare (i.e. exposed directly to air).</li> </ul>
Transportation	Excessive vibration and impact reduces the reliability of the products. Exercise caution when handling the products.

#### 11.10 Resin coating (including moisture-proof coating)

Before applying any resin coating, please consult our technical department.

#### 11.11 Mounting conditions

Check the mounting condition before using.

Using mounting conditions (nozzles, equipment conditions, etc.) that are not suitable for products may lead to pick up errors, misalignment, or damage to the product.

#### 11.12 Operating environment

Do not use this product under the following environmental conditions as it may cause deterioration of product quality.

(1) In the corrodible atmosphere such as acidic gases, alkaline gases, chlorine, sulfur gases, organic gases and etc. (the sea breeze, Cl<sub>2</sub>, H<sub>2</sub>S, NH<sub>3</sub>, SO<sub>2</sub>, NO<sub>2</sub>, etc)

(2) In the atmosphere where liquid such as organic solvent, may splash on the products.

(3) In the atmosphere where the temperature/humidity changes rapidly and it is easy to dew.

**11.13 Mounting density**

If this product is placed near heat-generating products, be sure to implement sufficient heat-dissipating measures.

If this product is subjected to a significant amount of heat from other products, this could adversely affect product quality, resulting in a circuit malfunction or failure of the mounted section. Also, be sure that the product is used in a manner so that the heat that the product is subjected to from other products does not exceed the upper limit of the rated operating temperature for the product.

**12. ⚠Note**

- (1) Please make sure that your product has been evaluated in view of your specifications with our product being mounted to your product.
- (2) You are requested not to use our product deviating from the reference specifications.
- (3) The contents of this reference specification are subject to change without advance notice. Please approve our product specifications or transact the approval sheet for product specifications before ordering.

**Appendix**

Electrical performance: Measuring method for inductance/Q (Q measurement is applicable only when the Q value is included in the rating table.)

Perform measurement using the method described below. (Perform correction for the error deriving from the measuring terminal.)

(1) Residual elements and stray elements of the measuring terminal can be expressed by the F parameter for the 2-pole terminal as shown in the figure below.

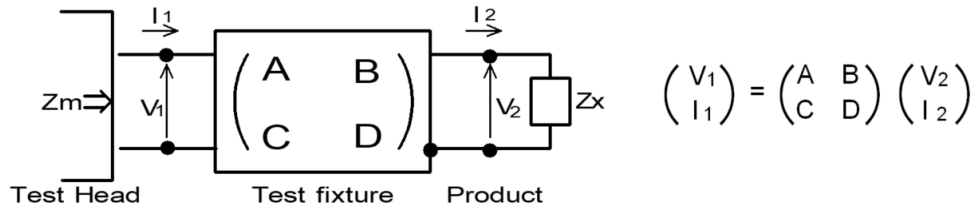

(2) The product's impedance value ( $Z_x$ ) and measured impedance value ( $Z_m$ ) can be expressed as shown below, by using the respective current and voltage for input/output.

$$Z_m = \frac{V_1}{I_1} \quad Z_x = \frac{V_2}{I_2}$$

(3) Thus, the relationship between the product's impedance value ( $Z_x$ ) and measured impedance value ( $Z_m$ ) is as follows.

$Z_x = \alpha \frac{Z_m - \beta}{1 - Z_m \Gamma}$	<p>Here,</p> <p><math>\alpha = D/A = 1</math></p> <p><math>\beta = B/D = Z_{sm} - (1 - Y_{om} Z_{sm}) Z_{ss}</math></p> <p><math>\Gamma = C/A = Y_{om}</math></p> <p><math>Z_{sm}</math>: measured impedance of short chip</p> <p><math>Z_{ss}</math>: residual impedance of short chip (0.480 nH)</p> <p><math>Y_{om}</math>: measured admittance when measuring terminal is open</p>
---	--

(4) Calculate inductance  $L_x$  and  $Q_x$  using the equations shown below.

$L_x = \frac{\text{Im}(Z_x)}{2\pi f}$	<p><math>L_x</math>: inductance of chip coil</p> <p><math>Q_x</math>: Q of chip coil</p> <p><math>f</math>: measuring frequency</p>
$Q_x = \frac{\text{Im}(Z_x)}{\text{Re}(Z_x)}$	