

Chip Ferrite Bead BLM18□□□□WH1D
Murata Standard Reference Specification[AEC-Q200]

1.Scope

This reference specification applies to Chip Ferrite Bead for Automotive Electronics BLM18_WH Series based on AEC-Q200.

2.Part Numbering

(ex.) BL M 18 AG 471 W H 1 D
 (1) (2) (3) (4) (5) (6) (7) (8) (9)

(1)Product ID (4)Characteristics (7)Category(for Automotive Electronics)
 (2)Type (5)Typical Impedance at 100MHz (8)Numbers of Circuit
 (3)Dimension (L×W) (6)Performance(for Conductive Glue) (9)Packaging (D:Taping/B:Bulk)

3.Rating

Customer Part Number	MURATA Part Number	Impedance (Ω) (at 100MHz)(*1) (refer to below comment)		Rated Current (mA)		DC Resistance (Ω max.)		ESD Rank
						Initial Values	Values After Testing	
		Typical	at 125°C	at 150°C				
	BLM18AG471WH1D	470±25%	470	1000	500	0.20	0.26	1B
	BLM18AG102WH1D	1000±25%	1000	200	200	0.70	0.8	
	BLM18KG260WH1D	26±25%	26	2000	1200	0.032	0.037	6
	BLM18KG300WH1D	30±25%	30	1850	1100	0.035	0.040	
	BLM18KG700WH1D	70±25%	70	1650	1000	0.047	0.057	
	BLM18KG101WH1D	100±25%	100	1500	900	0.055	0.065	
	BLM18KG121WH1D	120±25%	120	1500	900	0.055	0.065	
	BLM18KG221WH1D	220±25%	220	1400	800	0.080	0.090	
	BLM18KG331WH1D	330±25%	330	1250	700	0.110	0.125	
	BLM18KG471WH1D	470±25%	470	1100	600	0.160	0.175	
	BLM18KG601WH1D	600±25%	600	1000	500	0.180	0.195	
	BLM18KG102WH1D	1000±25%	1000	800	450	0.230	0.245	

• Operating Temperature : -55°C to +150°C

• Storage Temperature : -55°C to +150°C

Rated Current is derated as shown in the right figure depending on the operating temperature.

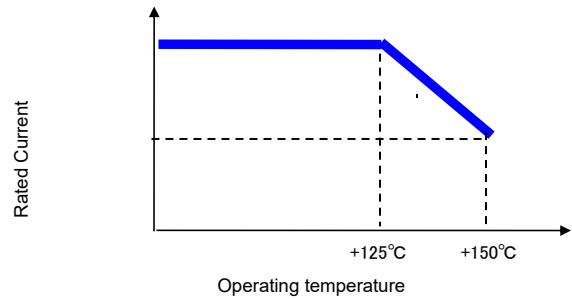

4.Style and Dimensions

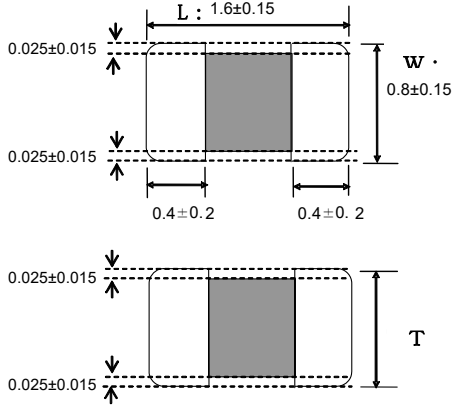

Item	T(mm)
BLM18KG260/300/700/101/121	0.6±0.15
BLM18KG221/331/471/601/102	0.8±0.15
BLM18AG	0.8±0.15

■ Equivalent Circuit

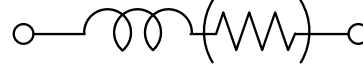

(Resistance element becomes dominant at high frequencies.)

■ Unit Mass (Typical value)

- BLM18KG260/300/700/101/121 : 0.004g
- BLM18KG221/331/471/601/102 : 0.005g
- BLM18AG

5.Marking

No marking.

6.Standard Testing Conditions

< Unless otherwise specified >

Temperature : Ordinary Temp. (15 °C to 35 °C)
 Humidity : Ordinary Humidity (25%(RH) to 85%(RH))

< In case of doubt >

Temperature : 20°C±2 °C
 Humidity : 60%(RH) to 70%(RH)
 Atmospheric pressure : 86kPa to 106kPa

7.Specifications

7-1.Electrical Performance

No.	Item	Specification	Test Method
6-1-1	Impedance	Meet item 3.	Measuring Frequency : 100MHz±1MHz Measuring Equipment : KEYSIGHT 4991A or the equivalent Test Fixture : KEYSIGHT 16192A or the equivalent
6-1-2	DC Resistance	Meet item 3.	Measuring Equipment : Digital multi meter *Except resistance of the Substrate and Wire

7-2. Mechanical Performance(based on Table 13 for FILTER EMI SUPPRESSORS/FILTERS)

AEC-Q200 Rev.D issued June. 1 2010

AEC-Q200			Murata Specification / Deviation						
No.	Stress	Test Method							
3	High Temperature Exposure	1000hours at 150deg C Set for 24hours at room temperature, then measured.	Meet Table A after testing. Table A <table border="1" style="margin-left: 20px;"> <tr> <td>Appearance</td> <td>No damage</td> </tr> <tr> <td>Impedance Change (at 100MHz)</td> <td>Within ±50%</td> </tr> <tr> <td>DC Resistance</td> <td>Meet item 3.</td> </tr> </table>	Appearance	No damage	Impedance Change (at 100MHz)	Within ±50%	DC Resistance	Meet item 3.
Appearance	No damage								
Impedance Change (at 100MHz)	Within ±50%								
DC Resistance	Meet item 3.								
4	Temperature Cycling	1000cycles -55 deg C to +150 deg C Set for 24hours at room temperature, then measured.	Meet Table A after testing.						
5	Destructive Physical Analysis	Per EIA469 No electrical tests	No defects						

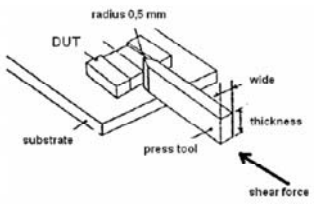
AEC-Q200			Murata Specification / Deviation						
No.	Stress	Test Method							
7	Biased Humidity	1000hours at 85 deg C, 85%RH Apply max rated current.	Meet Table B after testing. TableB <table border="1" style="margin-left: 20px;"> <tr> <td>Appearance</td> <td>No damage</td> </tr> <tr> <td>Impedance Change (at 100MHz)</td> <td>With in ±50% (BLM18KG) With in ±30% (BLM18AG)</td> </tr> <tr> <td>DC Resistance</td> <td>Meet item 3.</td> </tr> </table>	Appearance	No damage	Impedance Change (at 100MHz)	With in ±50% (BLM18KG) With in ±30% (BLM18AG)	DC Resistance	Meet item 3.
Appearance	No damage								
Impedance Change (at 100MHz)	With in ±50% (BLM18KG) With in ±30% (BLM18AG)								
DC Resistance	Meet item 3.								
8	Operational Life	Apply 150 deg C 1000hours Set for 24hours at room temperature, then measured	Meet Table A after testing. If the rated current of arts exceed 10mA, The operating temperature should be 125 deg C.						
9	External Visual	Visual inspection	No abnormalities						
10	Physical Dimension	Meet ITEM 4 (Style and Dimensions)	No defects						
12	Resistance to Solvents	Per MIL-STD-202 Method 215	Not Applicable						
13	Mechanical Shock	Per MIL-STD-202 Method 213 Condition F 1500g's (14.7N)/0.5ms/ Half sine	Meet Table C after testing. TableC <table border="1" style="margin-left: 20px;"> <tr> <td>Appearance</td> <td>No damage</td> </tr> <tr> <td>Impedance Change (at 100MHz)</td> <td>With in ±30%</td> </tr> <tr> <td>DC Resistance</td> <td>Meet item 3.</td> </tr> </table>	Appearance	No damage	Impedance Change (at 100MHz)	With in ±30%	DC Resistance	Meet item 3.
Appearance	No damage								
Impedance Change (at 100MHz)	With in ±30%								
DC Resistance	Meet item 3.								
14	Vibration	5g's(0.049N) for 20 minutes, 12cycles each of 3 orientations Test from 10-2000Hz.	Meet Table C after testing.						
15	Resistance to Soldering Heat	Solder temperature 260C+/-5 deg C Immersion time 10s	Not Applicable						
17	ESD	Per AEC-Q200-002	Meet Table C after testing. ESD Rank: Meet Item 3. (Rating)						
18	Solderability	Per J-STD-002	Not Applicable						
19	Electrical Characterization	Measured : Impedance	No defects						
20	Flammability	Per UL-94	Not Applicable						
21	Board Flex	Epoxy-PCB(1.6mm) Deflection 2mm(min) 60s minimum holding tim	Not Applicable						
22	Terminal Strength	Applying Force : 4.8N Applying Time : 5s±1s Applying Direction as shown below. 	Meet Table A after testing.						
30	Electrical Transient Conduction	Per ISO-7637-2	Not Applicable						

8.Specification of Packaging

8-1.Appearance and Dimensions (8mm-wide paper tape)

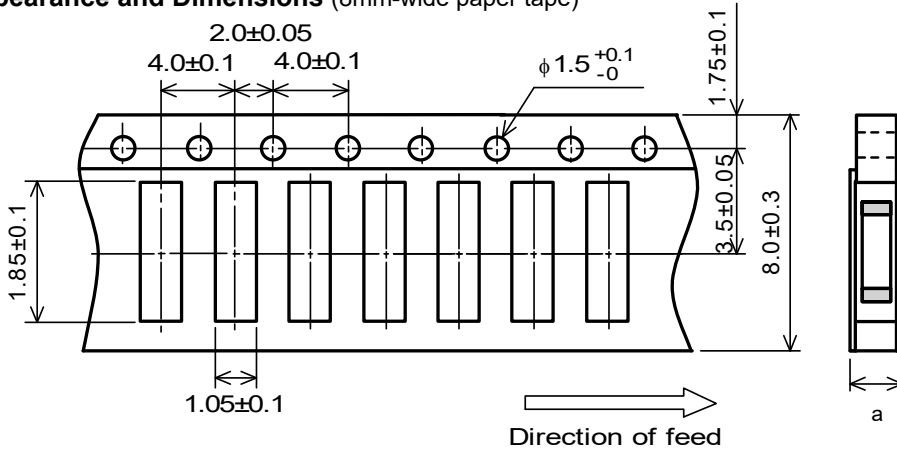

Item	Dimension "a"
BLM18KG260/300/700/101/121	0.85Max
BLM18KG221/331/471/601/102	1.10Max
BLM18AG	

(in mm)

(1) Taping

Products shall be packaged in the cavity of the base tape of 8mm-wide,4mm-pitch continuously and sealed by top tape and bottom tape.

(2) The sprocket holes are to the right as the tape is pulled toward the user.

(3) Spliced point:The base tape and top tape have no spliced point

(4) Cavity:There shall not be burr in the cavity.

(5) Missing components number

Missing components number within 0.025% of the number per reel or 1 pc., whichever is greater, and are not continuous. The specified quantity per reel are kept.

8-2.Tape Strength

(1) Pull Strength

Top tape	5N min.
Bottom tape	

(2)Peeling off force of Top tape

0.1N to 0.6N (Minimum value is typical.)

*Speed of Peeling off:300mm/min

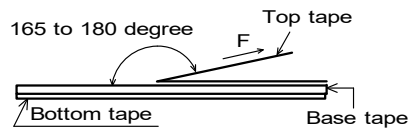

8-3.Taping Condition

(1)Standard quantity per reel

Quantity per 180mm reel: 4000 pcs. / reel

(2)There shall be leader-tape (top tape and empty tape) and trailer- tape(empty tape) as follows.

(3)On paper tape, the top tape and the base tape shall not be adhered at the tip of the empty leader tape for more than 5 pitch.

(4)Marking for reel

The following items shall be marked on a label and the label is stuck on the reel.

(Customer part number, MURATA part number, Inspection number(*1) , RoHS marking (*2) , Quantity, etc)

*1) « Expression of Inspection No. » □□ 0000 ×××
(1) (2) (3)

(1) Factory Code

(2) Date First digit : Year / Last digit of year
Second digit : Month / Jan. to Sep. → 1 to 9, Oct. to Dec. → O, N, D
Third, Fourth digit : Day

(3) Serial No.

*2) « Expression of RoHS marking » ROHS - Y (Δ)
(1) (2)

(1) RoHS regulation conformity parts.

(2) MURATA classification number

(5) Outside package

These reels shall be packed in the corrugated cardboard package and the following items shall be marked on a label and the label is stuck on the box.
 (Customer name, Purchasing order number, Customer part number, MURATA part number, RoHS discrimination(*2), Quantity, etc)

(6) Dimensions of reel and taping (leader-tape, trailer-tape)

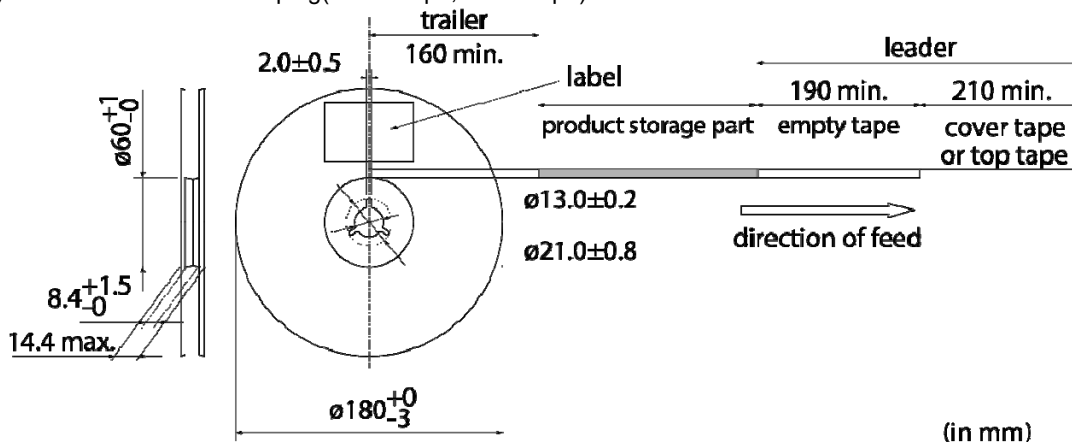

8-4. Specification of Outer Case

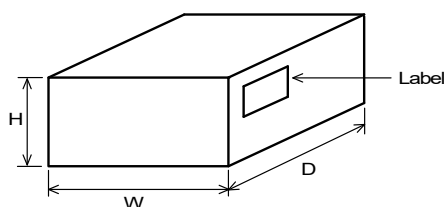

Outer Case Dimensions (mm)			Standard Reel Quantity in Outer Case (Reel)
W	D	H	
186	186	93	5

* Above Outer Case size is typical. It depends on a quantity of an order.

9. Caution

9-1. Rating

Do not use products beyond the Operating Temperature Range and Rated Current.

9-2. Operating Environment

- (1) Don't use our products over the operating temperature, because it may make the deterioration of their electric characteristics. In worst case, it may cause smoke from the adhesive because of the excessive heat.
- (2) Do not use this product in the corrodible atmosphere (acidic gases, alkaline gases, chlorine, sulfur gases, organic gases and etc.), because the atmosphere may cause deterioration of the electrical characteristic because of the corrosion of the inner electrodes and outer electrodes and deterioration of the adhesive.

9-3. Mounting Density

Don't be soldered on the substrate. This product must be mounted on the substrate with conductive glue. Add special attention to radiating heat of some products with heating when mounting our product near the products.

The excessive heat by other products may cause deterioration of our product's characteristics or incorrect operation, so be sure to use our product under the operating temperature including the heat from other products.

9-4. Fail Safe

Be sure to provide an appropriate fail-safe function on your product to prevent from a second damage that may be caused by the abnormal function or the failure of our products.

9-5. Limitation of Applications

Please contact us before using our products for the applications listed below which require especially high reliability for the prevention of defects which might directly cause damage to the third party's life, body or property.

- | | |
|----------------------------------|---|
| (1)Aircraft equipment | (6)Disaster prevention / crime prevention equipment |
| (2)Aerospace equipment | (7)Traffic signal equipment |
| (3)Undersea equipment | (8)Transportation equipment (trains,ships,etc.) |
| (4)Power plant control equipment | (9) Data-processing equipment |
| (5)Medical equipment | (10)Applications of similar complexity and /or reliability requirements to the applications listed in the above |

10. Notice

This product is designed for adhesive with conductive glue, so we can't guarantee for other connecting method. If you plan to take another connecting method, please contact us.

10-1. How to mount this product on a board with conductive glue

Please refer to the figure and table below which shows the method of recommended mounting with conductive glue.

(We recommend using a mounting machine to mount this product.)

Please coat print pads with recommended conductive glue "PC3000" manufactured by Heraeus with using metal mask and metal squeegee, and then mount our products on the substrates with a mount machine or human hand. Please put the substrates into a oven (140~150 °C) for 30 minutes in order to cure the adhesive. Please check whether the chips and the substrates are connected with the conductive glue or not and there is no electrically short of the conductive glue.

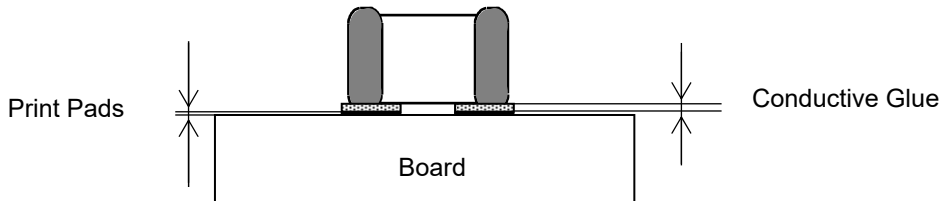

①Board	Ceramic Board or Alumina Board
②Thickness of Glue	30-50 μ m
③Recommended Conductive Glue	PC3000 (Manufactured by Heraeus)

10-2.Storage Conditions

(1)Storage period

Use the products within 6 months after delivered.
Adhesive performance should be checked if this period is exceeded.

(2)Storage conditions

- Products should be stored in the warehouse on the following conditions.
 - Temperature : -10°C to 40°C
 - Humidity : 15% to 85% relative humidity
 - No rapid change on temperature and humidity
- Don't keep products in corrosive gases such as sulfur, chlorine gas or acid, or it may cause oxidation of electrode, resulting in poor solderability.
- Products should be stored on the palette for the prevention of the influence from humidity, dust and so on.
- Products should be stored in the warehouse without heat shock, vibration, direct sunlight and so on.
- Products should be stored under the airtight packaged condition.

(3)Delivery

Care should be taken when transporting or handling product to avoid excessive vibration or mechanical shock.

11. ⚠ Note

- (1)Please make sure that your product has been evaluated in view of your specifications with our product being mounted to your product.
- (2)You are requested not to use our product deviating from the agreed specifications.
- (3) The contents of this reference specification are subject to change without advance notice. Please approve our product specifications or transact the approval sheet for product specifications before ordering.

Mouser Electronics

Authorized Distributor

Click to View Pricing, Inventory, Delivery & Lifecycle Information:

Murata:

[BLM18AG102WH1D](#) [BLM18AG471WH1D](#) [BLM18KG101WH1D](#) [BLM18KG102WH1D](#) [BLM18KG121WH1D](#)
[BLM18KG221WH1D](#) [BLM18KG260WH1D](#) [BLM18KG300WH1D](#) [BLM18KG331WH1D](#) [BLM18KG471WH1D](#)
[BLM18KG601WH1D](#) [BLM18KG700WH1D](#)