



A Product Line of  
Diodes Incorporated



# SPECIFICATION FOR APPROVAL

CUSTOMER	
NOMINAL FREQUENCY	<b>25.000000 MHz</b>
PRODUCT TYPE	<b>TYPE GC 49S SMD QUARTZ CRYSTAL</b>
PART NUMBER	<b>GC2500126</b>
CUSTOMER P/N	
ISSUE DATE	<b>April 23, 2018</b>
VERSION	<b>E</b>

APPROVED	PREPARED	QA
Brenda Kuo	Claire Cheng	Dony Yang

## Diodes Incorporated

No.2, Ziqiang 5th Rd., Zhongli Industrial Park,  
Zhongli Dist., Taoyuan City 32063, Taiwan (R.O.C.)  
TEL:886-3-451-8888  
FAX:886-3-461-3865  
<https://www.diodes.com>

\*RoHS Compliant

\*HF-Halogen Free

\*REACH Compliant

# TYPE GC 49S SMD QUARTZ CRYSTAL

## GC2500126

VER.E 23-APR-18

### VERSION HISTORY

Version No.	Version Date	Description	Notes
A	Jul. 2, 2010	Initial Release	
B	Jul. 22, 2010	Changed ESR from 40ohms to 30ohms	
C	Oct. 1, 2010	Changed calibration tolerance from +/-30ppm to +/-20ppm and changed freq. stability from +/-30ppm to +/-25ppm	
D	Jul. 29, 2011	Updated Suggested IR Reflow Profile & Format	
E	Apr. 23, 2018	Updated logo	

# TYPE GC 49S SMD QUARTZ CRYSTAL

## GC2500126

VER.E 23-APR-18

### ELECTRICAL SPECIFICATIONS

Item	Symbol	Specifications	Units	Notes
Nominal Frequency	Fn	25.000000	MHz	
Mode of Oscillation	MO	AT Cut-Fundamental		
Calibration Load Capacitance	CL	16	pF	
Calibration Tolerance	FL	± 20	ppm	at 25°C±3°C
Operating Temperature Range	TR	-20 to +70	°C	
Frequency Stability(Frequency Deviation over the Operating Temperature Range)	F/T	± 25	ppm	Reference to the Frequency at 25°C
Operating Drive Level		100	μW	
Maximum Drive Level		500	μW	
Equivalent Series Resistance	ESR	30	Ω	Max.
Shunt Capacitance	C0	7	pF	Max.
Aging at 25°C		± 5	ppm	Max, 1st year
Storage Temperature		-55 to +125	°C	
Insulation Resistance		500	MΩ	Min

# TYPE GC 49S SMD QUARTZ CRYSTAL

**GC2500126**

VER.E 23-APR-18

## RELIABILITY SPECIFICATIONS

### MECHANICAL AND ENVIRONMENTAL RATINGS:

- a) FINE LEAK TEST: JESD22-A109 (Condition 1A)
- b) GROSS LEAK TEST: JESD22-A109 (Condition C)
- c) MOISTURE RESISTANCE: JESD22-A113
- d) SHOCK: JESD22-B104 (Condition B)
- e) SOLDERABILITY : (RoHS version): J-STD-002
- f) VIBRATION: JESD22-B103
- g) SOLVENT RESISTANCE: JESD22-B107
- h) RESISTANCE TO SOLDERING HEAT (RoHS version): J-STD-020D Table 5.2 Pb free devices (3 cycles max)

## SUGGESTED IR REFLOW PROFILE

\*As per IPC-JEDEC J-STD-020D

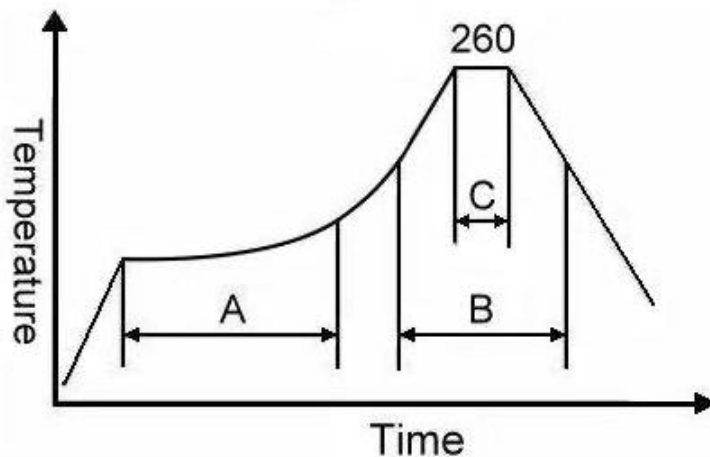

Note:

	Stage	Temperature	Time
A	Preheat	150~200°C	60~120 Sec
B	Primary Heat	217°C	60~150 Sec
C	Peak	260°C	10 Sec

# TYPE GC 49S SMD QUARTZ CRYSTAL

## GC2500126

VER.E 23-APR-18

### MARKING

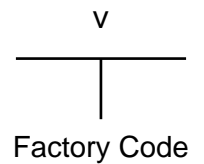
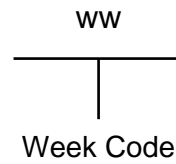
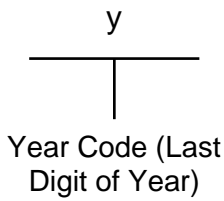
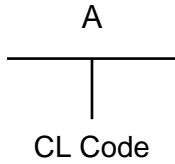
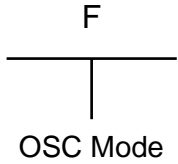
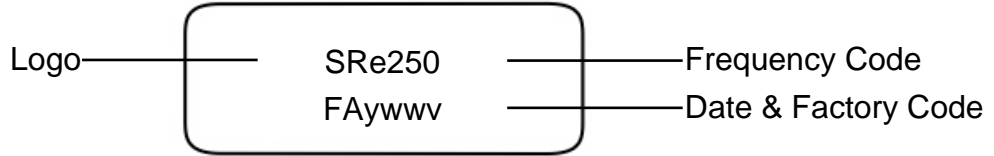

### MECHANICAL DRAWINGS ( Scale: None. Dimensions are in mm.)

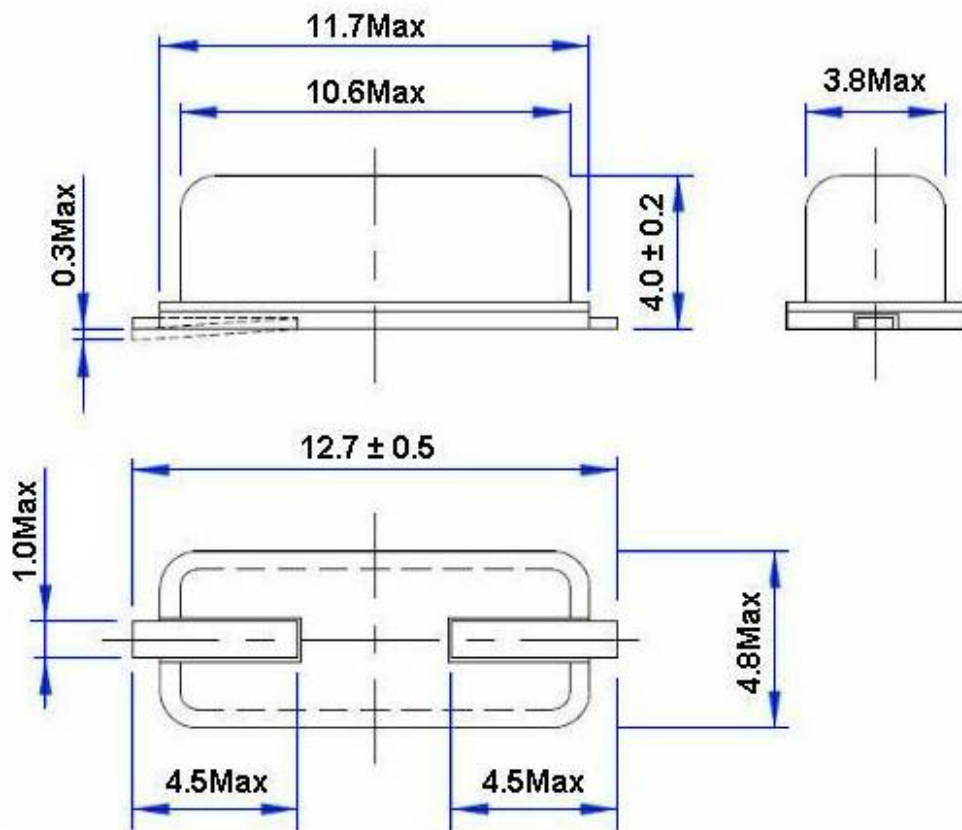

# TYPE GC 49S SMD QUARTZ CRYSTAL

## GC2500126

VER.E 23-APR-18

### PACKING

