

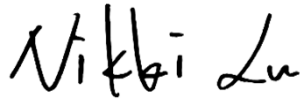

PSE Technology Corporation

SPECIFICATION FOR APPROVAL

CUSTOMER	_____
NOMINAL FREQUENCY	32.768 KHz
PRODUCT TYPE	TYPE G4 SMD X'TAL
SPEC. NO. (P/N)	G43270018
CUSTOMER P/N	_____
ISSUE DATE	Nov.9,2012
VERSION	F

APPROVED	PREPARED	QA
		
APPROVED BY CUSTOMER :		AVL Status
Please return one copy with approval to PSE-TW		

PSE Technology Corporation

No.2, Tzu-Chiang 5th Rd, Chung Li Industrial Park,
 Chung Li City, Taoyuan County, Taiwan (R.O.C.)
 TEL: 886-3-451-8888
 FAX: 886-3-461-3865
<http://www.saronix-ecera.com.tw>

*RoHS Exception
 *HF-Halogen Free
 *REACH Compliant

*** A company of  **PERICOM Semiconductor Corporation** ***

TYPE G4 SMD X'TAL

G43270018

VER. F 9-Nov-12

ELECTRICAL SPECIFICATIONS

SRe Part Number : G43270018

Parameters	Symbol	Specifications	Units	Notes
Nominal Frequency	Fn	32.768	KHz	
Frequency Tolerance	FT	± 20	ppm	at 25 °C ± 5 °C
Load Capacitance	CL	6	pF	Typ.
Drive Level	DL	1	μW	Max.
Equivalent Series Resistance	ESR	50	KΩ	Max.
Temperature Coefficient	K	-0.035	ppm/°C ²	Typ.
Shunt Capacitance	C0	1.6	pF	Typ.
Operating Temperature Range	TR	-40~85	°C	
Storage Temperature Range		-55~85	°C	
Aging		± 3	ppm	Max 1st year
Insulation Resistance		500	MΩ	Min.

Reliability (Mechanical and Environmental Endurance)

No.	Test Items	Test Method and Condition	Requirements
1	Vibration	(1) Vibration Frequency: 10 to 55Hz (2) Vibration Amplitude: 1.5mm (3) Cycle Time: 1-2min(10-55-10Hz) (4) Direction: X.Y.Z (5) Duration: 2h/each direction	Frequency Change: ±10ppm Max. Resistance Change: ±15% or 5kΩ Max.
2	Shock	3 Times free drop from 75cm height to hard wooden board of thickness more than 30mm	Frequency Change: ±10ppm Max. Resistance Change: ±15% or 5kΩ Max.
3	Leakage	Put crystal units into a hermetic container and Helium for 0.5-0.6Mpa, and keep it for 1h; Check the leakage by a Helium leak detector	Leakage: 1x10 ⁻⁸ Pa·m ³ /s Max.

TYPE G4 SMD X'TAL

G43270018

VER. F 9-Nov-12

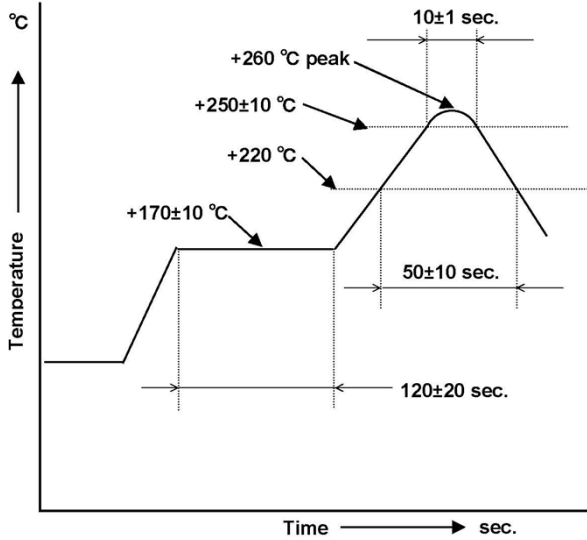
4	Reflow soldering	 <p>Note: the temperature used herein means the temperature on the circuit board. Reflow: 2 times max.</p>	<p>Frequency Change: ± 10ppm Max. Frequency Change: ± 10ppm Max. Resistance Change: $\pm 25\%$ or 10kΩ Max.</p>
5	Lead Strength (DIP)	The crystal lead with the 0.9kg(9N) power (keep it for 30s \pm 5s) and bend the crystal lead 90° with 0.45kg power and two times	The crystal lead is not abnormality
6	High Temperature Endurance	The crystal units shall be put in somewhere for 2 hrs at temperature of -85°C \pm 2°C, then keep it for 1 to 2 hrs under room temperature.	Frequency Change: ± 10 ppm Max. Resistance Change: $\pm 15\%$ or 5k Ω Max.
7	Low Temperature Endurance	The crystal units shall be put in somewhere for 2 hrs at temperature of -25°C, then keep it for 1 to 2 hrs under room temperature.	
8	Humidity Endurance	The crystal units shall be put in somewhere at 40°C in relative humidity of 90-95% for 48 hrs, then keep it for one or two hours under room temperature.	
9	Temperature Cycle	Temperature shift from low(-40°C) to high(100°C, keep 30 mins), satisfy high(100°C) to low(-40°C, keep 30 mins), then go up to room temperature for 5 cycles.	
10	Salt Spray Test	Put the crystal units in the salt spray room (salt density: 5%) at the temperature of 35°C for 96 hrs. Then clean it with water and dry its surface.	The appearance shall has no abnormality and soldering is good. Frequency Change: ± 10 ppm Max. Resistance Change: $\pm 15\%$ or 5k Ω Max.

TYPE G4 SMD X'TAL

G43270018

VER. F 9-Nov-12

Marking

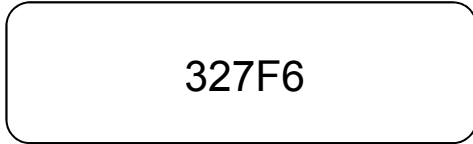

Dimensions (Units: mm)

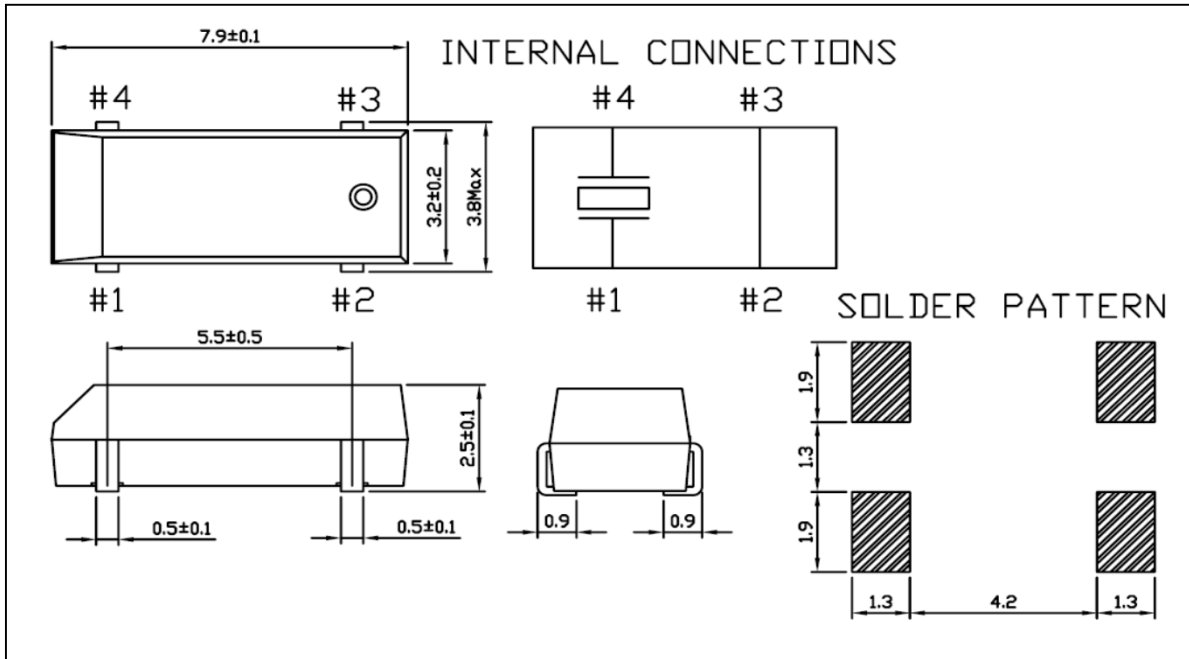

TYPE G4 SMD X'TAL

G43270018

VER. F 9-Nov-12

TAPE AND REEL SPECIFICATION

1. Tape and Reel form conform to EIA-481-B
2. The quantity of crystal units per reel shall be 3000PCS.
3. A "LABEL" on which necessary information is clearly written is on the surface of packing box and the reel.

CARRIER TAPE DIMENSIONS

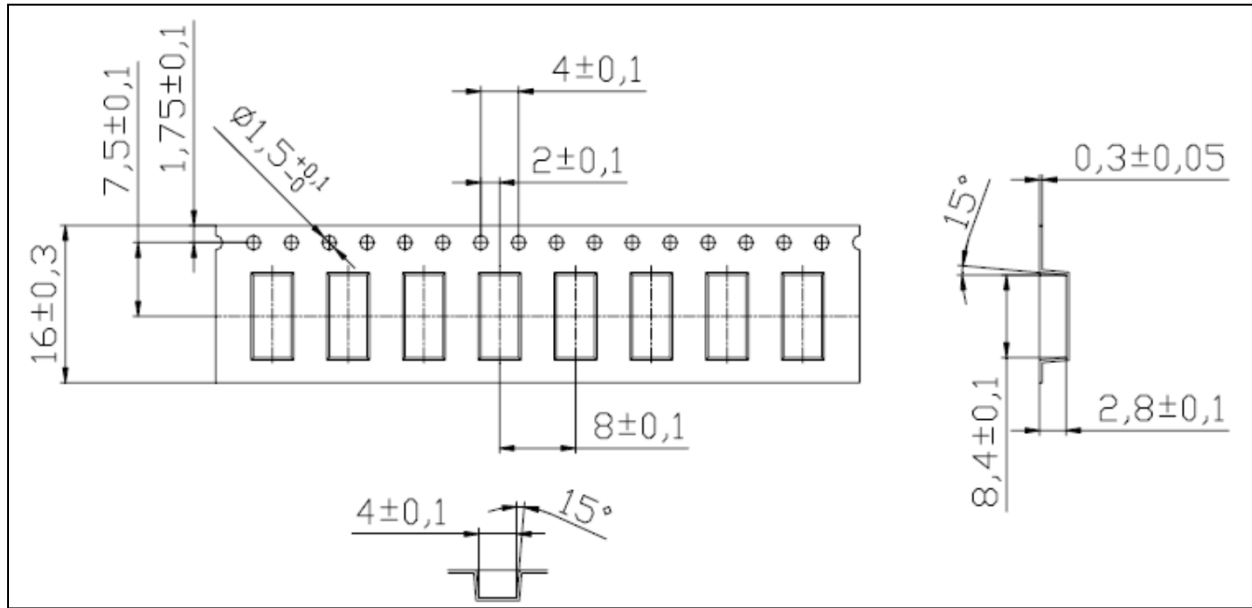

REEL DIMENSIONS

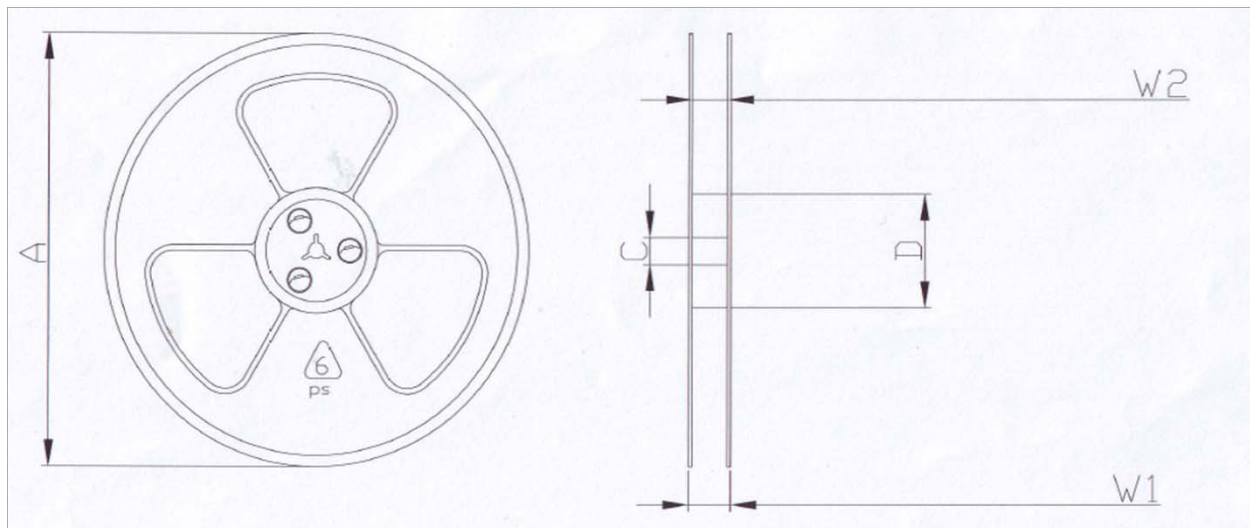

規格	A $\pm 0,5$	C $\pm 0,2$	D $\pm 0,3$	W1 $\pm 0,2$	W2 $^{+0,4}_{+0,2}$
330*100*16	330	25	100	20	16

Mouser Electronics

Authorized Distributor

Click to View Pricing, Inventory, Delivery & Lifecycle Information:

[Diodes Incorporated:](#)

[G43270018](#)