



PSE Technology Corporation

SPECIFICATION FOR APPROVAL

CUSTOMER	_____
NOMINAL FREQUENCY	25.000000 MHz
PRODUCT TYPE	TYPE FY 5.0x3.2 SEAM SEALED CRYSTAL
PART NUMBER	FY2500115
CUSTOMER P/N	_____
ISSUE DATE	December 11, 2013
VERSION	B

APPROVED	PREPARED	QA
		
APPROVED BY CUSTOMER		
Please return one copy with approval to PSE-TW		

PSE Technology Corporation

No.2, Tzu-Chiang 5th Rd., Chung Li Industrial Park,
 Chung Li City, Taoyuan County, Taiwan (R.O.C.)
 TEL:886-3-451-8888
 FAX:886-3-461-3865
<http://www.saronix-ecera.com.tw/>

- *Pb-free
- *RoHS Compliant
- *HF-Halogen Free
- *REACH Compliant

A Company of PERICOM Semiconductor Corporation

TYPE FY 5.0x3.2 SEAM SEALED CRYSTAL

FY2500115

VER.B 11-DEC-13

VERSION HISTORY

Version No.	Version Date	Customer Receipt Date	Supplier Receipt Date	Description	Notes
A	Dec. 4, 2013			Initial Release	
B	Dec. 11, 2013			Changed ESR from 30ohms max to 50ohms max, Operating Drive Level from 10uW to 100uW & Maximum Drive Level from 100uW to 300uW	

TYPE FY 5.0x3.2 SEAM SEALED CRYSTAL

FY2500115

VER.B 11-DEC-13

ELECTRICAL SPECIFICATIONS

Item	Symbol	Specifications	Units	Notes
Nominal Frequency	Fn	25.000000	MHz	
Mode of Oscillation	MO	AT Cut-Fundamental		
Calibration Load Capacitance	CL	8	pF	
Calibration Tolerance	FL	± 10	ppm	at 25°C±3°C
Operating Temperature Range	TR	-20 to +70	°C	
Frequency Stability(Frequency Deviation over the Operating Temperature Range)	F/T	± 10	ppm	Reference to the Frequency at 25°C
Operating Drive Level		100	μW	
Maximum Drive Level		300	μW	
Equivalent Series Resistance	ESR	50	Ω	Max.
Shunt Capacitance	C0	5	pF	Max.
Aging at 25°C		± 5	ppm	Max, 1st year
Storage Temperature		-55 to +125	°C	
Insulation Resistance		500	MΩ	Min

** This product doesn't include harmful substance that stipulated by SONY SS-00259 Level 1 and S-AT2-001 Level 1 standard. RoHS Compliant (Pb - Free).

TYPE FY 5.0x3.2 SEAM SEALED CRYSTAL

FY2500115

VER.B 11-DEC-13

RELIABILITY SPECIFICATIONS

MECHANICAL AND ENVIRONMENTAL RATINGS:

- a) FINE LEAK TEST: JESD22-A109 (Condition 1A)
- b) GROSS LEAK TEST: JESD22-A109 (Condition C)
- c) MOISTURE RESISTANCE: JESD22-A113
- d) SHOCK: JESD22-B104 (Condition B)
- e) SOLDERABILITY : (RoHS version): J-STD-002
- f) VIBRATION: JESD22-B103
- g) SOLVENT RESISTANCE: JESD22-B107
- h) RESISTANCE TO SOLDERING HEAT (RoHS version): J-STD-020D Table 5.2 Pb free devices (3 cycles max)

SUGGESTED IR REFLOW PROFILE

*As per IPC-JEDEC J-STD-020D



Note:

	Stage	Temperature	Time
A	Preheat	150~200°C	60~120 Sec
B	Primary Heat	217°C	60~150 Sec
C	Peak	260°C	10 Sec

For soldering reflow profile and reliability test ratings go to: <http://www.pericom.com/pdf/sre/reflow.pdf>

TYPE FY 5.0x3.2 SEAM SEALED CRYSTAL

FY2500115

VER.B 11-DEC-13

MARKING

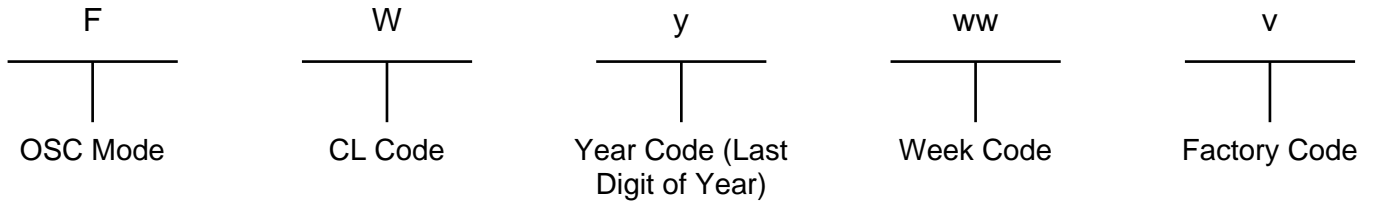

MECHANICAL DRAWINGS (Scale: None. Dimensions are in mm.)

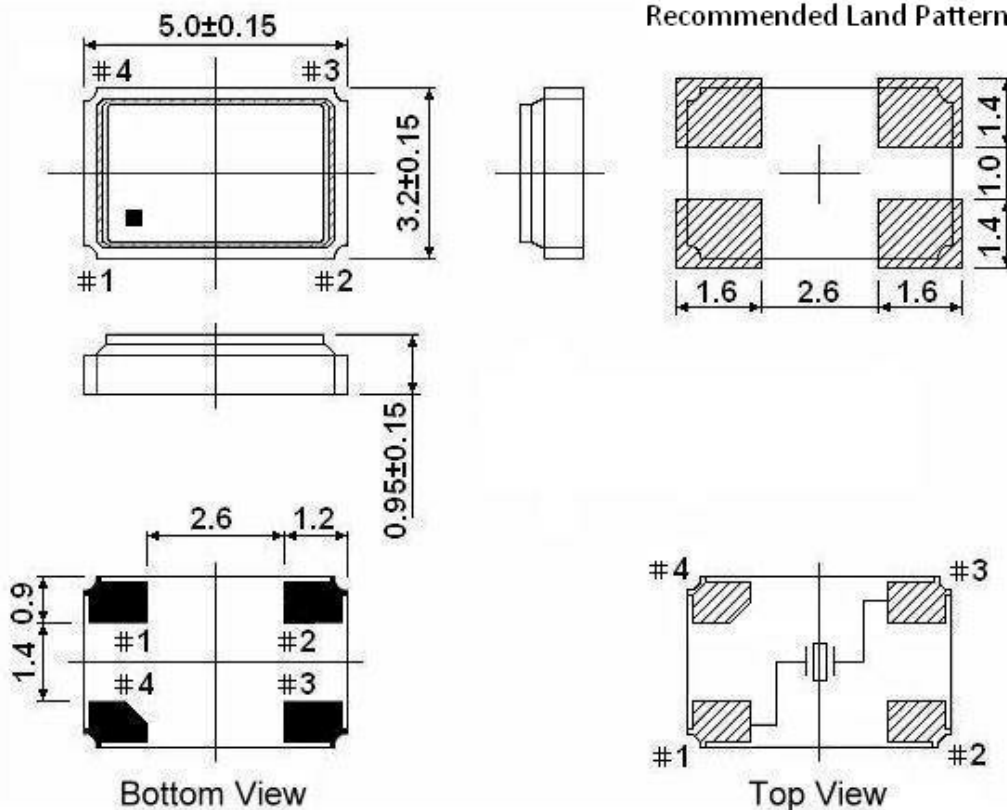

**** Recommended - Pin 1 & 3 : CRYSTAL
Pin 2 & 4 : GND**

Notes:

1. Package drawings are for reference only, and the appearances of objects may vary. Actual packages are based on the real product.
2. The marking dot denotes Pin#1.
3. The position and shape of the chamfer pin may vary and are based on the real product.

TYPE FY 5.0x3.2 SEAM SEALED CRYSTAL

FY2500115

VER.B 11-DEC-13

Tape & Reel

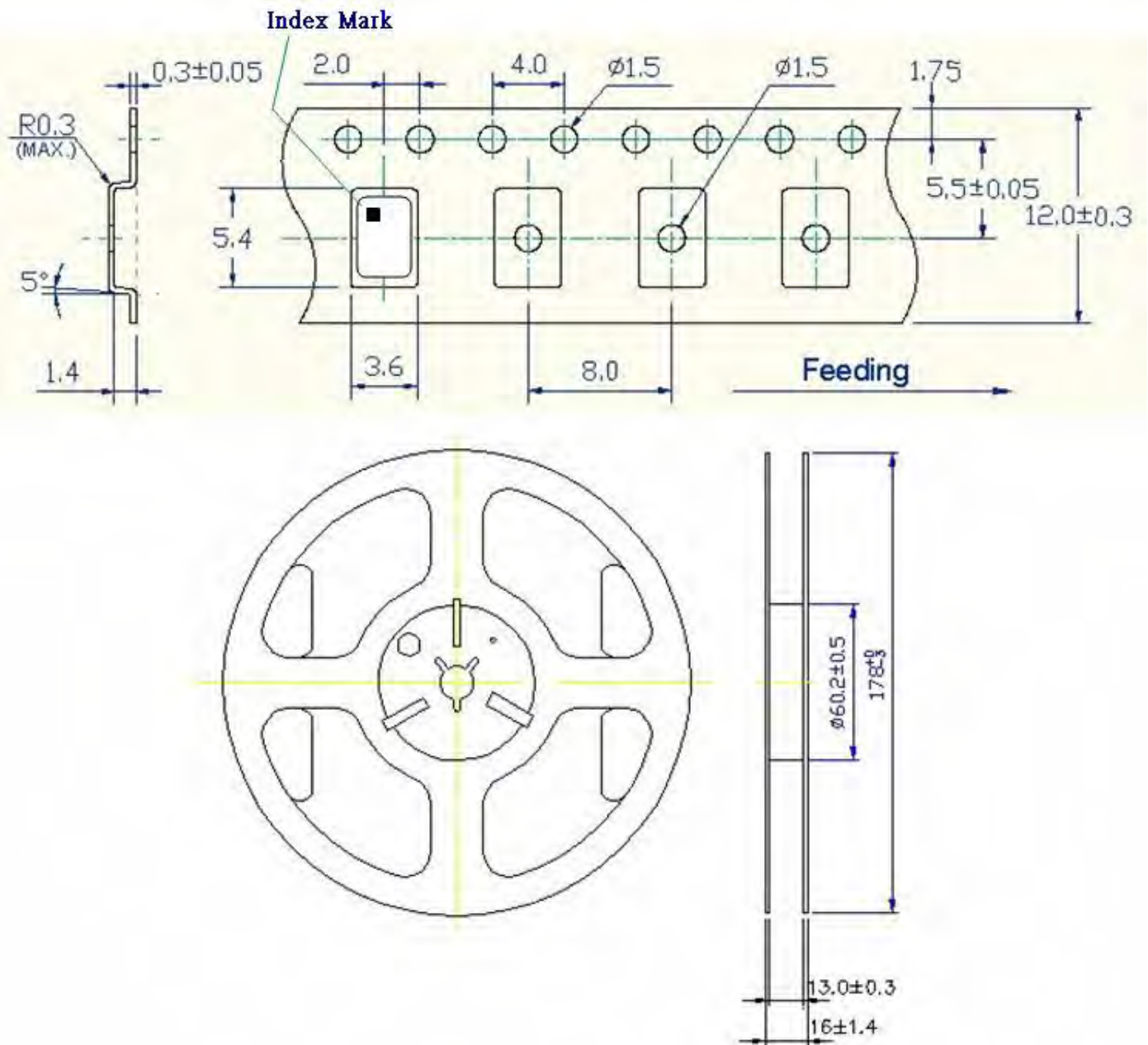

1. 230mm minimum leader which consist of carrier and/or tape followed by a minimum of 160mm of empty carrier tape sealed with cover tape.
2. 160mm minimum trailer of empty carrier tape sealed with cover tape.

TYPE FY 5.0x3.2 SEAM SEALED CRYSTAL

FY2500115

VER.B 11-DEC-13

PACKING

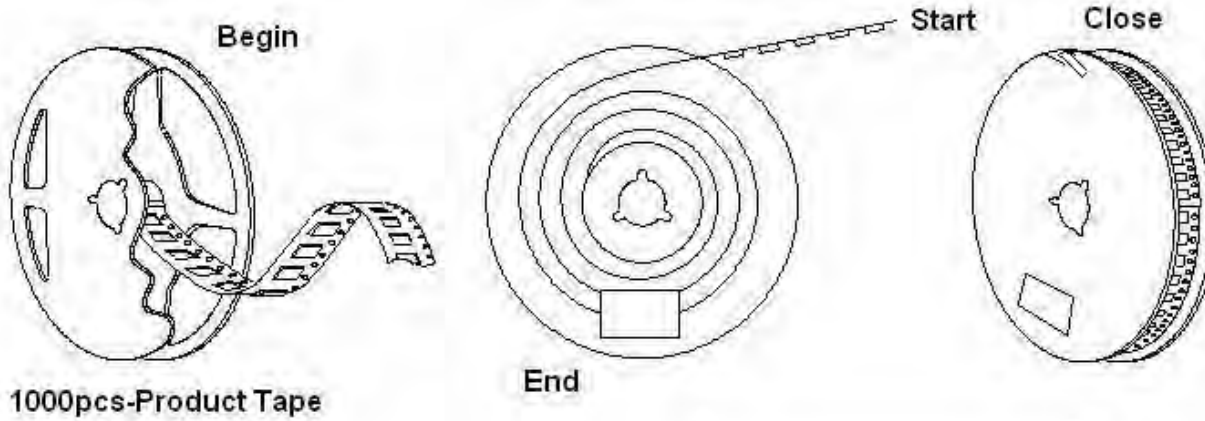

1000pcs-Product Tape

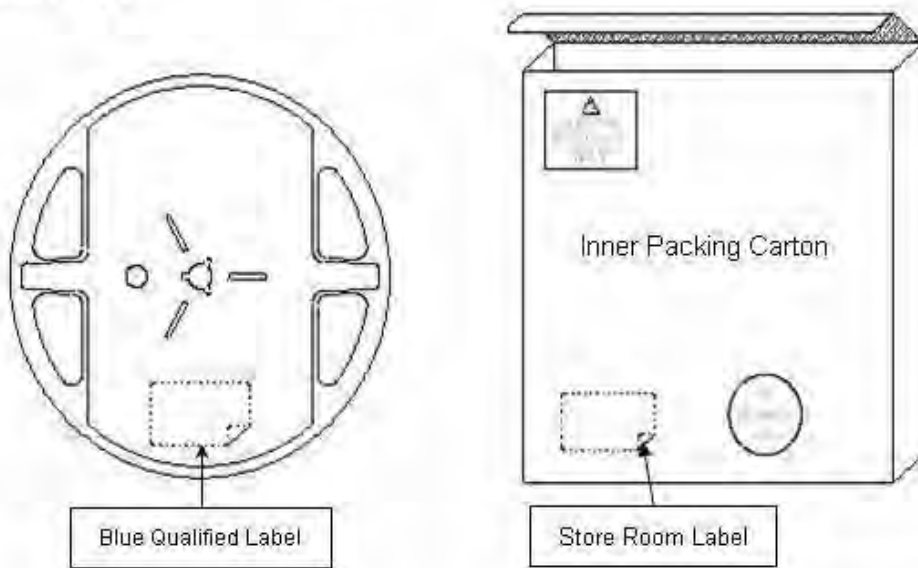

Blue Qualified Label

Store Room Label

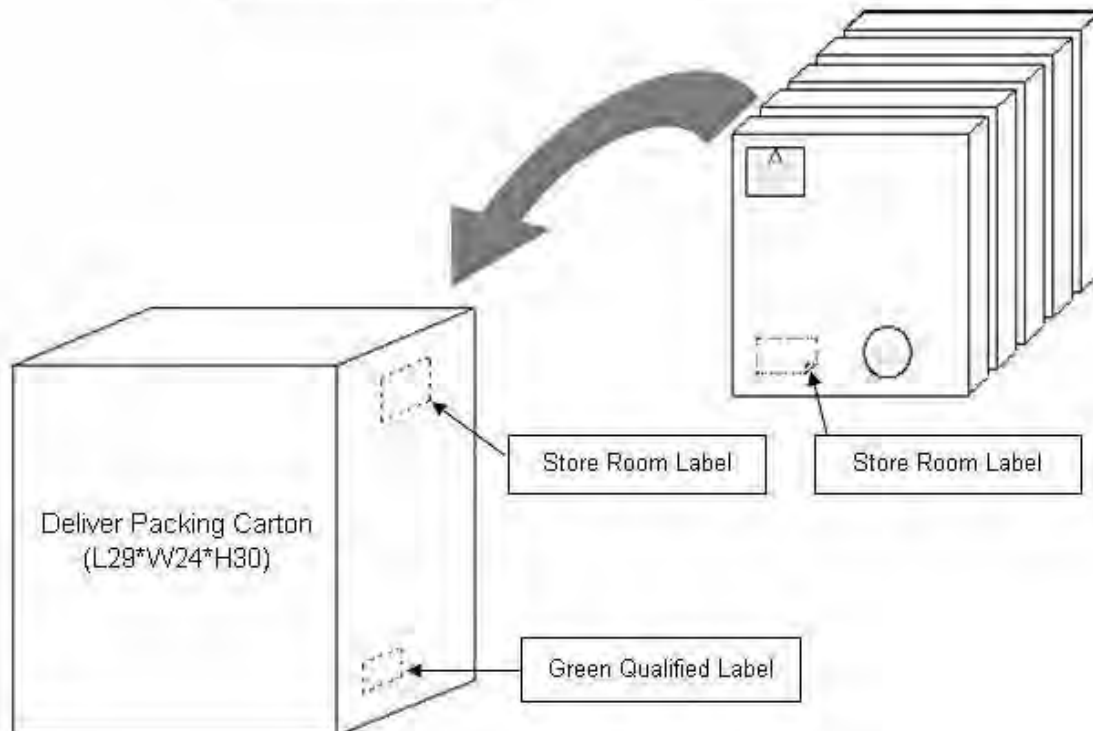

Store Room Label

Store Room Label

Green Qualified Label

Mouser Electronics

Authorized Distributor

Click to View Pricing, Inventory, Delivery & Lifecycle Information:

[Diodes Incorporated:](#)

[FY2500115](#)