

Product Summary

| BV _{DSS} | R _{DS(ON)} Max | I _D T _C = +25°C |
|-------------------|--------------------------------|------------------------------------------|
| 100V | 14.5mΩ @ V _{GS} = 10V | 50.5A |
| | 19.5mΩ @ V _{GS} = 6V | 43.6A |

Description

This new generation N-Channel Enhancement Mode MOSFET is designed to minimize R_{DS(ON)}, yet maintain superior switching performance. This device is ideal for use in notebook battery power management and load switch.

Applications

- Motor Control
- DC-DC Converters
- Power Management

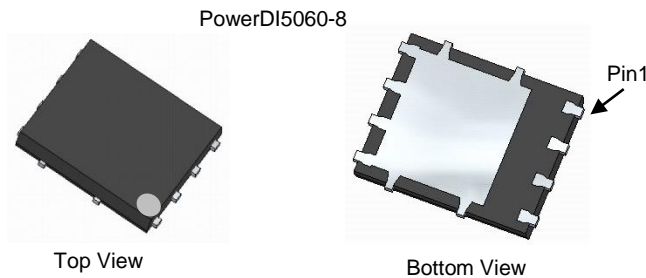

Features

- Rated to +175°C—Ideal for High Ambient Temperature Environments
- 100% Unclamped Inductive Switching (UIS) Test in Production—Ensures More Reliable and Robust End Application
- Thermally Efficient Package—Cooler Running Applications
- Low R_{DS(ON)}—Minimizes On-State Losses
- Low Input Capacitance
- Fast Switching Speed
- **Lead-Free Finish; RoHS Compliant (Notes 1 & 2)**
- **Halogen and Antimony Free. "Green" Device (Note 3)**
- **Qualified to AEC-Q101 Standards for High Reliability**

Mechanical Data

- Case: PowerDI[®]5060-8
- Case Material: Molded Plastic, "Green" Molding Compound. UL Flammability Classification Rating 94V-0
- Moisture Sensitivity: Level 1 per J-STD-020
- Terminal Connections Indicator: See Diagram
- Terminals: Finish – Matte Tin Annealed over Copper Leadframe. Solderable per MIL-STD-202, Method 208
- Weight: 0.097 grams (Approximate)

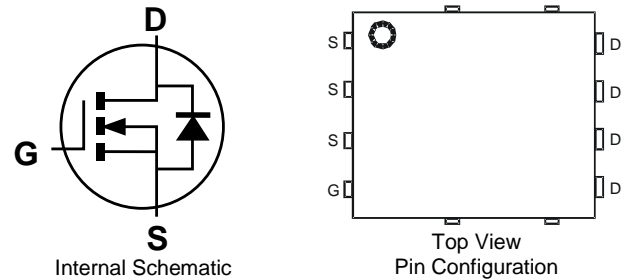

Ordering Information (Note 4)

| Part Number | Case | Packaging |
|------------------|---------------|------------------|
| DMTH10H015SPS-13 | PowerDI5060-8 | 2500/Tape & Reel |

- Notes:
1. EU Directive 2002/95/EC (RoHS), 2011/65/EU (RoHS 2) & 2015/863/EU (RoHS 3) compliant. All applicable RoHS exemptions applied.
 2. See <https://www.diodes.com/quality/lead-free/> for more information about Diodes Incorporated's definitions of Halogen- and Antimony-free, "Green" and Lead-free.
 3. Halogen- and Antimony-free "Green" products are defined as those which contain <900ppm bromine, <900ppm chlorine (<1500ppm total Br + Cl) and <1000ppm antimony compounds.
 4. For packaging details, see <https://www.diodes.com/design/support/packaging/diodes-packaging/>.

Marking Information

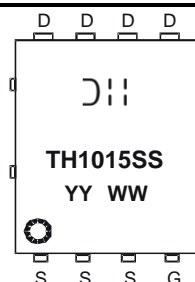

DII = Manufacturer's Marking
 TH1015SS = Product Type Marking Code
 YYWW = Date Code Marking
 YY = Last Two Digits of Year (ex: 18 = 2018)
 WW = Week Code (01 to 53)

Maximum Ratings (@T_A = +25°C, unless otherwise specified.)

| Characteristic | | | Symbol | Value | Unit |
|---------------------------------------------------------|--------------|---------------------------------------------------|------------------|--------------|------|
| Drain-Source Voltage | | | V _{DSS} | 100 | V |
| Gate-Source Voltage | | | V _{GSS} | ±20 | V |
| Continuous Drain Current (Note 5) V _{GS} = 10V | Steady State | T _A = +25°C T _A = +100°C | I _D | 8.4 5.9 | A |
| | Steady State | T _C = +25°C T _C = +100°C | I _D | 50.5 35.7 | A |
| Pulsed Drain Current (10µs Pulse, Duty Cycle = 1%) | | | I _{DM} | 120 | A |
| Maximum Continuous Body Diode Forward Current (Note 5) | | | I _S | 1.5 | A |
| Avalanche Current (Note 7) L = 3mH | | | I _{AS} | 7.5 | A |
| Avalanche Energy (Note 7) L = 3mH | | | E _{AS} | 85 | mJ |
| Avalanche Current, L = 0.1mH | | | I _{AS} | 15.8 | A |
| Avalanche Energy, L = 0.1mH | | | E _{AS} | 12.5 | mJ |

Thermal Characteristics

| Characteristic | | Symbol | Value | Unit |
|--------------------------------------------------|------------------------|-----------------------------------|-------------|------|
| Total Power Dissipation (Note 5) | T _A = +25°C | P _D | 1.5 | W |
| Thermal Resistance, Junction to Ambient (Note 5) | | R _{θJA} | 98 | °C/W |
| Total Power Dissipation | T _C = +25°C | P _D | 55 | W |
| Thermal Resistance, Junction to Case | | R _{θJC} | 2.7 | °C/W |
| Operating and Storage Temperature Range | | T _J , T _{STG} | -55 to +175 | °C |

Electrical Characteristics (@T_A = +25°C, unless otherwise specified.)

| Characteristic | Symbol | Min | Typ | Max | Unit | Test Condition |
|-----------------------------------------|---------------------|-----|------|------|------|--------------------------------------------------------------------------------------------|
| OFF CHARACTERISTICS (Note 6) | | | | | | |
| Drain-Source Breakdown Voltage | BV _{DSS} | 100 | — | — | V | V _{GS} = 0V, I _D = 1mA |
| Zero Gate Voltage Drain Current | I _{DSS} | — | — | 1 | µA | V _{DS} = 80V, V _{GS} = 0V |
| Gate-Source Leakage | I _{GSS} | — | — | ±100 | nA | V _{GS} = ±20V, V _{DS} = 0V |
| ON CHARACTERISTICS (Note 6) | | | | | | |
| Gate Threshold Voltage | V _{GS(TH)} | 2 | — | 4 | V | V _{DS} = V _{GS} , I _D = 250µA |
| Static Drain-Source On-Resistance | R _{DS(ON)} | — | 11.3 | 14.5 | mΩ | V _{GS} = 10V, I _D = 20A |
| | | — | 14.7 | 19.5 | | V _{GS} = 6V, I _D = 20A |
| Diode Forward Voltage | V _{SD} | — | 0.9 | 1.3 | V | V _{GS} = 0V, I _S = 20A |
| DYNAMIC CHARACTERISTICS (Note 7) | | | | | | |
| Input Capacitance | C _{iss} | — | 2343 | — | pF | V _{DS} = 50V, V _{GS} = 0V f = 1MHz |
| Output Capacitance | C _{oss} | — | 487 | — | | |
| Reverse Transfer Capacitance | C _{riss} | — | 26 | — | | |
| Gate Resistance | R _G | — | 0.69 | — | Ω | V _{DS} = 0V, V _{GS} = 0V, f = 1MHz |
| Total Gate Charge | Q _G | — | 30.1 | — | nC | V _{DD} = 50V, I _D = 10A, V _{GS} = 10V |
| Gate-Source Charge | Q _{GS} | — | 7.5 | — | | |
| Gate-Drain Charge | Q _{GD} | — | 6.5 | — | | |
| Turn-On Delay Time | t _{D(ON)} | — | 9.8 | — | ns | V _{DD} = 50V, V _{GS} = 10V, I _D = 10A, R _G = 6Ω |
| Turn-On Rise Time | t _R | — | 7.8 | — | | |
| Turn-Off Delay Time | t _{D(OFF)} | — | 22.5 | — | | |
| Turn-Off Fall Time | t _F | — | 9.6 | — | | |
| Reverse Recovery Time | t _{RR} | — | 43.1 | — | ns | I _F = 10A, di/dt = 100A/µs |
| Reverse Recovery Charge | Q _{RR} | — | 65.1 | — | nC | |

- Notes:
5. Device mounted on FR-4 PCB, with minimum recommended pad layout, single sided.
 6. Short duration pulse test used to minimize self-heating effect.
 7. Guaranteed by design. Not subject to product testing.

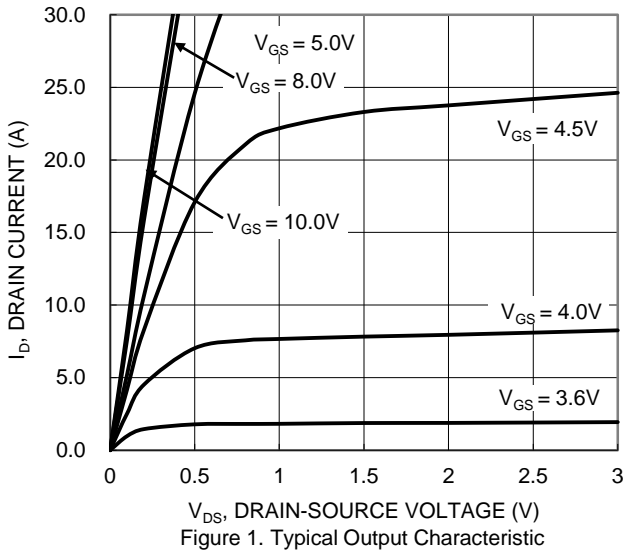

Figure 1. Typical Output Characteristic

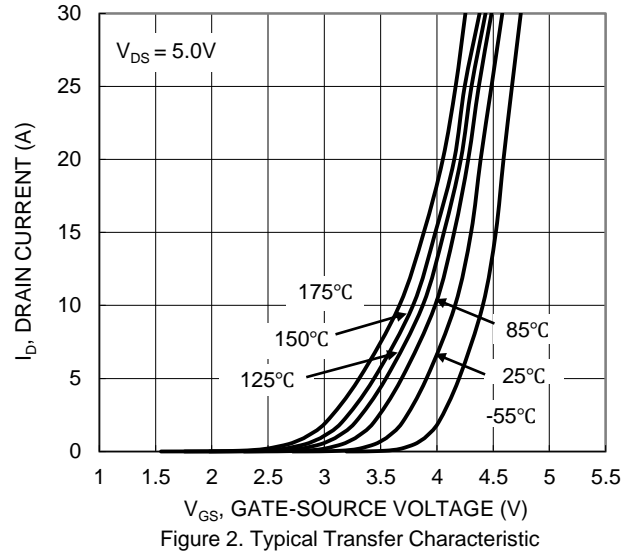

Figure 2. Typical Transfer Characteristic

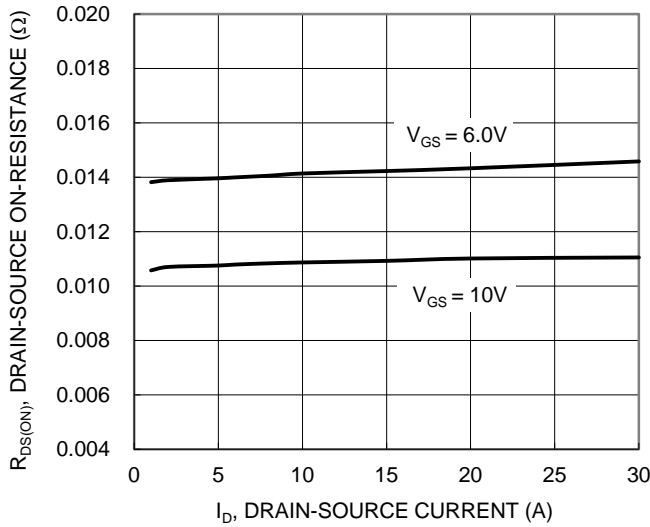

Figure 3. Typical On-Resistance vs. Drain Current and Gate Voltage

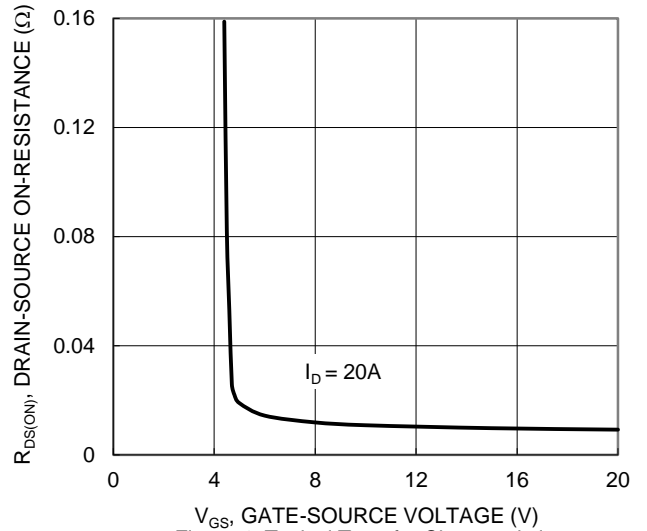

Figure 4. Typical Transfer Characteristic

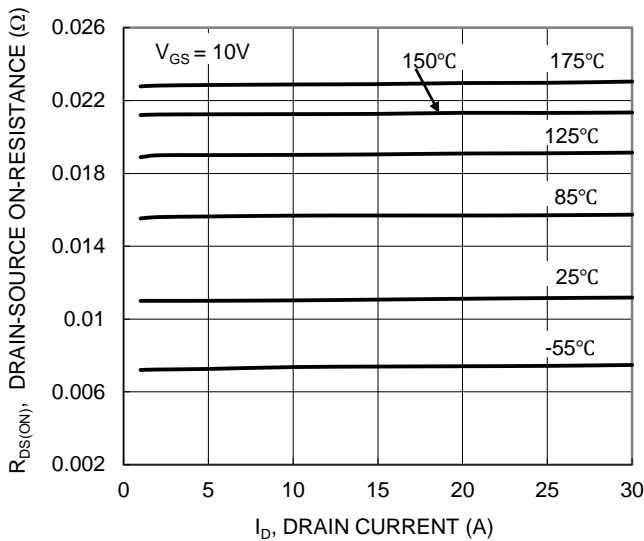

Figure 5. Typical On-Resistance vs. Drain Current and Temperature

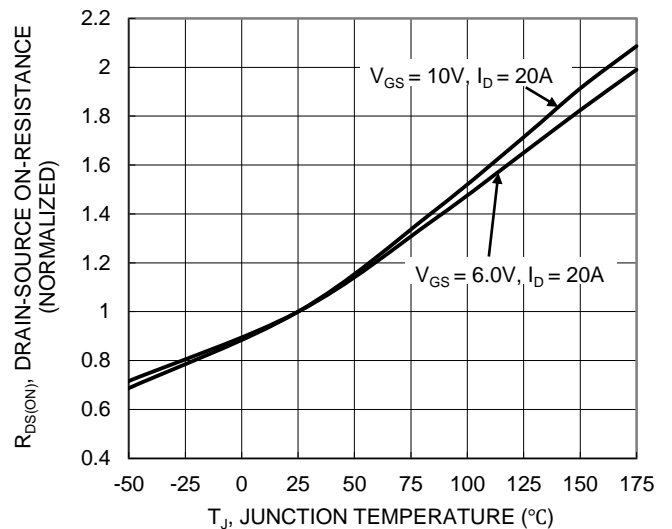
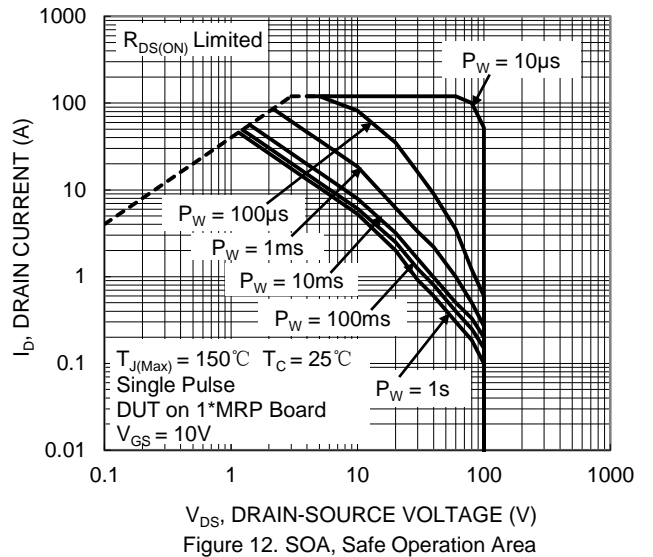
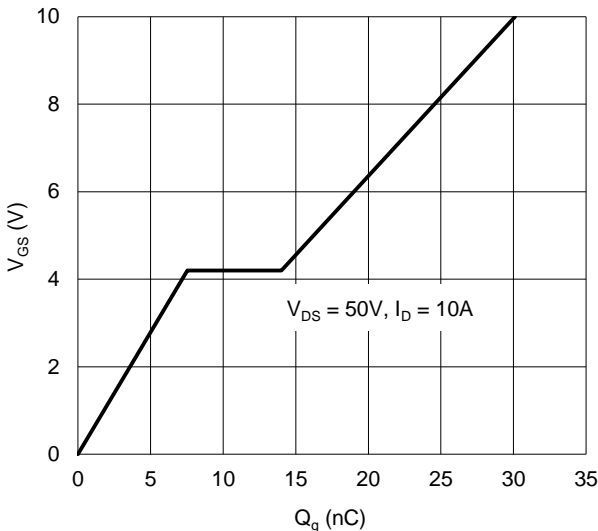
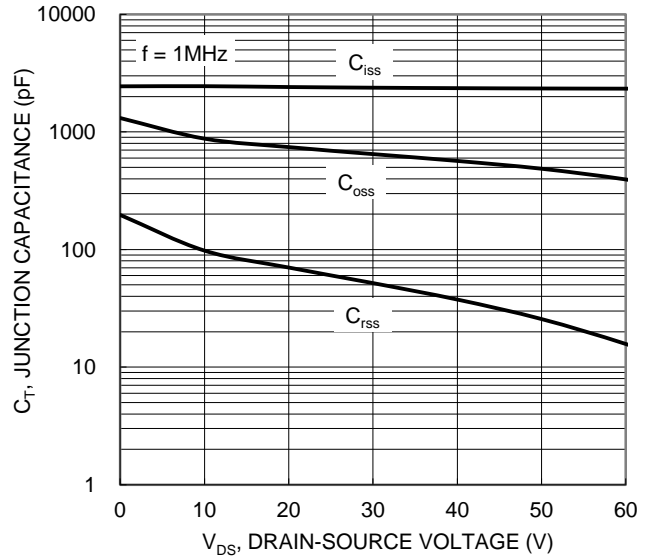
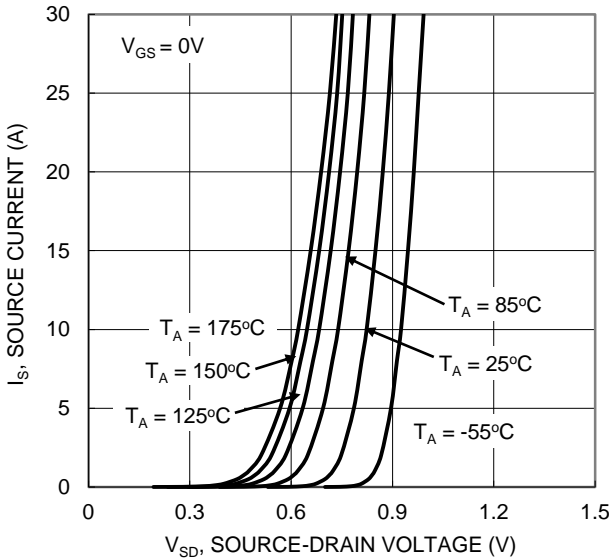
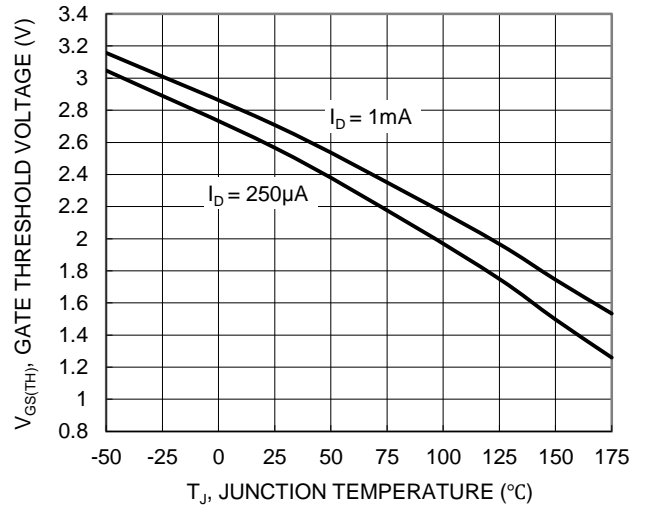
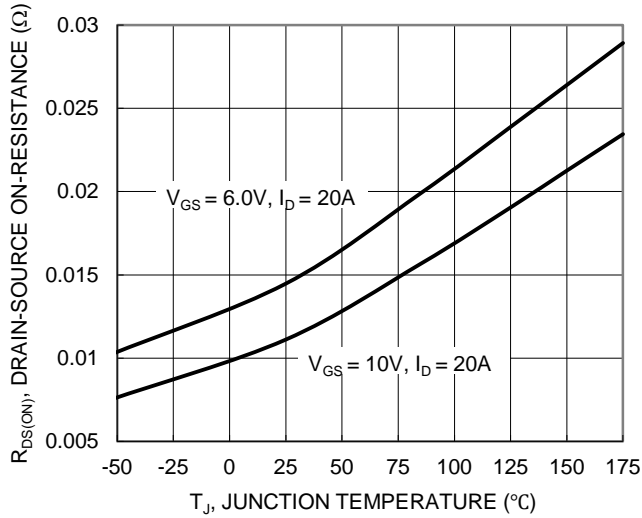

Figure 6. On-Resistance Variation with Temperature



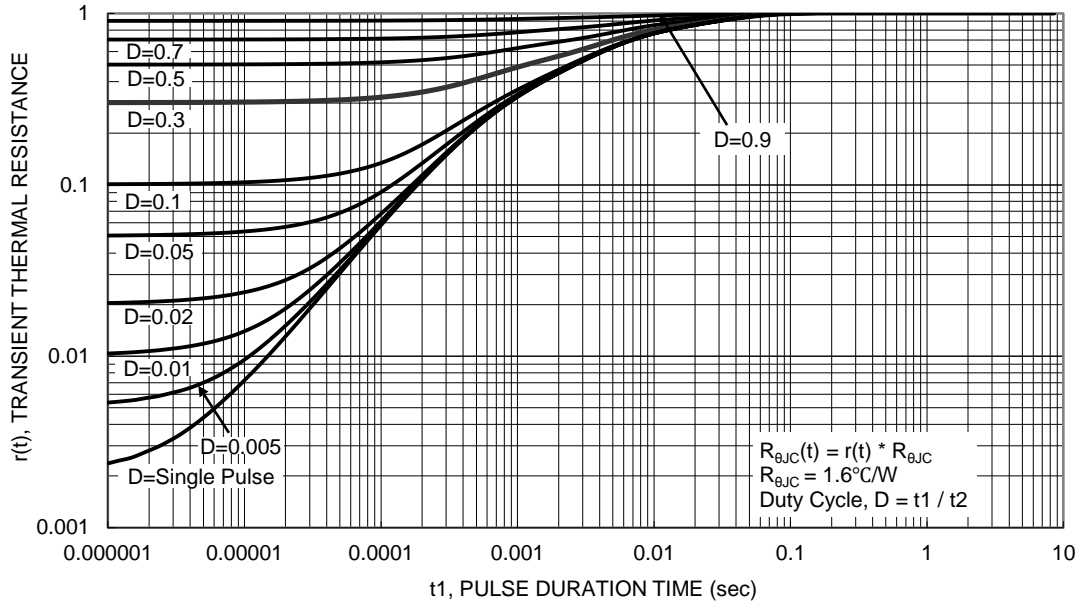
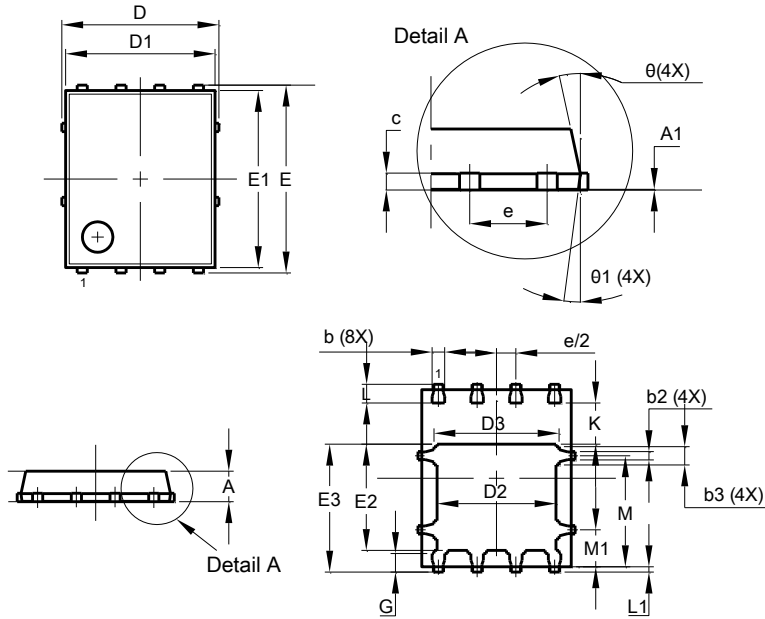

Figure 13. Transient Thermal Resistance

Package Outline Dimensions

Please see <http://www.diodes.com/package-outlines.html> for the latest version.

PowerDI5060-8



| PowerDI5060-8 | | | |
|----------------------|----------|-------|-------|
| Dim | Min | Max | Typ |
| A | 0.90 | 1.10 | 1.00 |
| A1 | 0.00 | 0.05 | - |
| b | 0.33 | 0.51 | 0.41 |
| b2 | 0.200 | 0.350 | 0.273 |
| b3 | 0.40 | 0.80 | 0.60 |
| c | 0.230 | 0.330 | 0.277 |
| D | 5.15 BSC | | |
| D1 | 4.70 | 5.10 | 4.90 |
| D2 | 3.70 | 4.10 | 3.90 |
| D3 | 3.90 | 4.30 | 4.10 |
| E | 6.15 BSC | | |
| E1 | 5.60 | 6.00 | 5.80 |
| E2 | 3.28 | 3.68 | 3.48 |
| E3 | 3.99 | 4.39 | 4.19 |
| e | 1.27 BSC | | |
| G | 0.51 | 0.71 | 0.61 |
| K | 0.51 | - | - |
| L | 0.51 | 0.71 | 0.61 |
| L1 | 0.100 | 0.200 | 0.175 |
| M | 3.235 | 4.035 | 3.635 |
| M1 | 1.00 | 1.40 | 1.21 |
| θ | 10° | 12° | 11° |
| θ1 | 6° | 8° | 7° |
| All Dimensions in mm | | | |

Suggested Pad Layout

Please see <http://www.diodes.com/package-outlines.html> for the latest version.

PowerDI5060-8

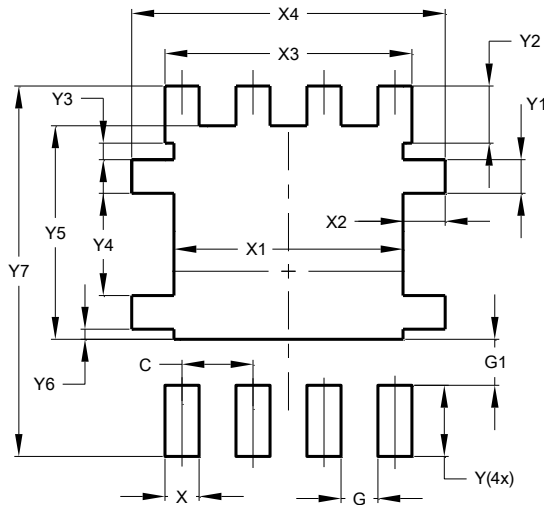

| Dimensions | Value (in mm) |
|------------|---------------|
| C | 1.270 |
| G | 0.660 |
| G1 | 0.820 |
| X | 0.610 |
| X1 | 4.100 |
| X2 | 0.755 |
| X3 | 4.420 |
| X4 | 5.610 |
| Y | 1.270 |
| Y1 | 0.600 |
| Y2 | 1.020 |
| Y3 | 0.295 |
| Y4 | 1.825 |
| Y5 | 3.810 |
| Y6 | 0.180 |
| Y7 | 6.610 |

IMPORTANT NOTICE

DIODES INCORPORATED MAKES NO WARRANTY OF ANY KIND, EXPRESS OR IMPLIED, WITH REGARDS TO THIS DOCUMENT, INCLUDING, BUT NOT LIMITED TO, THE IMPLIED WARRANTIES OF MERCHANTABILITY AND FITNESS FOR A PARTICULAR PURPOSE (AND THEIR EQUIVALENTS UNDER THE LAWS OF ANY JURISDICTION).

Diodes Incorporated and its subsidiaries reserve the right to make modifications, enhancements, improvements, corrections or other changes without further notice to this document and any product described herein. Diodes Incorporated does not assume any liability arising out of the application or use of this document or any product described herein; neither does Diodes Incorporated convey any license under its patent or trademark rights, nor the rights of others. Any Customer or user of this document or products described herein in such applications shall assume all risks of such use and will agree to hold Diodes Incorporated and all the companies whose products are represented on Diodes Incorporated website, harmless against all damages.

Diodes Incorporated does not warrant or accept any liability whatsoever in respect of any products purchased through unauthorized sales channel. Should Customers purchase or use Diodes Incorporated products for any unintended or unauthorized application, Customers shall indemnify and hold Diodes Incorporated and its representatives harmless against all claims, damages, expenses, and attorney fees arising out of, directly or indirectly, any claim of personal injury or death associated with such unintended or unauthorized application.

Products described herein may be covered by one or more United States, international or foreign patents pending. Product names and markings noted herein may also be covered by one or more United States, international or foreign trademarks.

This document is written in English but may be translated into multiple languages for reference. Only the English version of this document is the final and determinative format released by Diodes Incorporated.

LIFE SUPPORT

Diodes Incorporated products are specifically not authorized for use as critical components in life support devices or systems without the express written approval of the Chief Executive Officer of Diodes Incorporated. As used herein:

A. Life support devices or systems are devices or systems which:

1. are intended to implant into the body, or
2. support or sustain life and whose failure to perform when properly used in accordance with instructions for use provided in the labeling can be reasonably expected to result in significant injury to the user.

B. A critical component is any component in a life support device or system whose failure to perform can be reasonably expected to cause the failure of the life support device or to affect its safety or effectiveness.

Customers represent that they have all necessary expertise in the safety and regulatory ramifications of their life support devices or systems, and acknowledge and agree that they are solely responsible for all legal, regulatory and safety-related requirements concerning their products and any use of Diodes Incorporated products in such safety-critical, life support devices or systems, notwithstanding any devices- or systems-related information or support that may be provided by Diodes Incorporated. Further, Customers must fully indemnify Diodes Incorporated and its representatives against any damages arising out of the use of Diodes Incorporated products in such safety-critical, life support devices or systems.

Copyright © 2018, Diodes Incorporated

www.diodes.com

Mouser Electronics

Authorized Distributor

Click to View Pricing, Inventory, Delivery & Lifecycle Information:

[Diodes Incorporated:](#)

[DMTH10H015SPS-13](#)