

PNP PRE-BIASED SMALL SIGNAL DUAL SURFACE MOUNT TRANSISTOR
Features

- Epitaxial Planar Die Construction
- Complementary NPN Types Available (DDC)
- Built-In Biasing Resistors
- **Totally Lead-Free & Fully RoHS Compliant (Notes 1 & 2)**
- **Halogen and Antimony Free. "Green" Device (Note 3)**
- **Qualified to AEC-Q101 Standards for High Reliability**
- **PPAP Capable (Note 4)**

Part Number	R1 (NOM)	R2 (NOM)
DDA124EU	22kΩ	22kΩ
DDA144EU	47kΩ	47kΩ
DDA114YU	10kΩ	47kΩ
DDA123JU	2.2kΩ	47kΩ
DDA114EU	10kΩ	10kΩ

Mechanical Data

- Case: SOT363
- Case Material: Molded Plastic, "Green" Molding Compound
- UL Flammability Classification Rating 94V-0
- Moisture Sensitivity: Level 1 per J-STD-020
- Terminals: Finish – Matte Tin Plated Leads, Solderable per MIL-STD-202, Method 208 Ⓢ3
- Weight: 0.006 grams (Approximate)

Part Number	R1 Only
DDA113TU	1kΩ
DDA143TU	4.7kΩ
DDA114TU	10kΩ



Top View

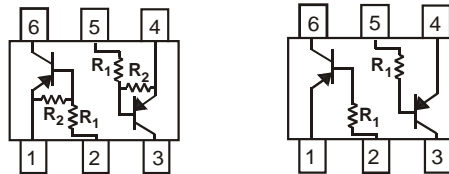

R1, R2

R1 Only

Device Schematic

Ordering Information (Notes 4, 5 & 6)

Product	Status	Compliance	Marking	Reel Size (inches)	Tape Width (mm)	Quantity per Reel
DDA124EU-7-F	Active	AEC-Q101	P17	7	8	3,000
DDA124EUQ-7-F	Active	Automotive	P17	7	8	3,000
DDA124EUQ-13-F	Active	Automotive	P17	13	8	10,000
DDA144EU-7-F	Active	AEC-Q101	P20	7	8	3,000
DDA144EUQ-7-F	Active	Automotive	P20	7	8	3,000
DDA114YU-7-F	Active	AEC-Q101	P14	7	8	3,000
DDA114YUQ-7-F	NRND (Use ADA114YUQ)	Automotive	P14	7	8	3,000
DDA123JU-7-F	Active	AEC-Q101	P06	7	8	3,000
DDA114EU-7-F	Active	AEC-Q101	P13	7	8	3,000
DDA114EUQ-7-F	NRND (Use ADA114EUQ)	Automotive	P13	7	8	3,000
DDA113TU-7-F	Active	AEC-Q101	P01	7	8	3,000
DDA143TU-7-F	Active	AEC-Q101	P07	7	8	3,000
DDA143TUQ-7-F	Active	Automotive	P07	7	8	3,000
DDA143TUQ-13-F	Active	Automotive	P07	13	8	10,000
DDA114TU-7-F	Active	AEC-Q101	P12	7	8	3,000
DDA114TUQ-7-F	Active	Automotive	P12	7	8	3,000
DDA114TUQ-13-F	Active	Automotive	P12	13	8	10,000

- Notes:
1. No purposely added lead. Fully EU Directive 2002/95/EC (RoHS), 2011/65/EU (RoHS 2) & 2015/863/EU (RoHS 3) compliant.
 2. See <https://www.diodes.com/quality/lead-free/> for more information about Diodes Incorporated's definitions of Halogen- and Antimony-free, "Green" and Lead-free.
 3. Halogen- and Antimony-free "Green" products are defined as those which contain <900ppm bromine, <900ppm chlorine (<1500ppm total Br + Cl) and <1000ppm antimony compounds.
 4. Automotive products are AEC-Q101 qualified and are PPAP capable. Automotive, AEC-Q101 and standard products are electrically and thermally the same, except where specified. For more information, please refer to <http://www.diodes.com/quality/>.
 5. For packaging details, go to our website at <https://www.diodes.com/design/support/packaging/diodes-packaging/>.
 6. NRND = Not Recommended for New Design.

Marking Information

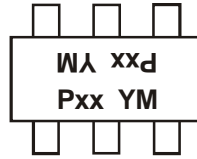

Pxx = Product Type Marking Code (See Ordering Information)
 YM = Date Code Marking
 Y = Year (ex: F = 2018)
 M = Month (ex: 9 = September)

Date Code Key

Year	2018	2019	2020	2021	2022	2023	2024	2025	2026	2027	2028	2029	2030	2031
Code	F	G	H	I	J	K	L	M	N	O	P	Q	R	S
Month	Jan	Feb	Mar	Apr	May	Jun	Jul	Aug	Sep	Oct	Nov	Dec		
Code	1	2	3	4	5	6	7	8	9	O	N	D		

Absolute Maximum Ratings (@T_A = +25°C, unless otherwise specified.)

Characteristic	Symbol	Value	Unit
Supply Voltage (1) to (6) and (4) to (3)	V _{CC}	-50	V
Input Voltage (1) to (2) and (4) to (5)	V _{IN}	+10 to -40 +10 to -40 +6 to -40 +5 to -12 +10 to -40 +5V Max +5V Max +5V Max	V
Output Current	I _O	-30 -30 -70 -100 -50 -100 -100 -100	mA
Output Current	I _{C(MAX)}	-100	mA

Thermal Characteristics (@T_A = +25°C, unless otherwise specified.)

Characteristic	Symbol	Value	Unit
Power Dissipation (Notes 7 & 8)	P _D	200	mW
Thermal Resistance, Junction to Ambient Air (Note 7)	R _{θJA}	625	°C/W
Operating and Storage Temperature Range	T _J , T _{STG}	-55 to +150	°C

Notes: 7. Mounted on FR-4 PC Board with minimum recommended pad layout.
 8. 150mW per element must not be exceeded.

Electrical Characteristics (@T_A = +25°C, unless otherwise specified.)

Characteristic (DDA113TU & DDA143TU & DDA114TU only)	Symbol	Min	Typ	Max	Unit	Test Condition
Collector-Base Breakdown Voltage	BV _{CBO}	-50	—	—	V	I _C = -50μA
Collector-Emitter Breakdown Voltage	BV _{CEO}	-50	—	—	V	I _C = -1mA
Emitter-Base Breakdown Voltage	BV _{EBO}	-5	—	—	V	I _E = -50μA
Collector Cutoff Current	I _{CBO}	—	—	-0.5	μA	V _{CB} = -50V
Emitter Cutoff Current	I _{EBO}	—	—	-0.5	μA	V _{EB} = -4V
Collector-Emitter Saturation Voltage	V _{CE(SAT)}	—	—	-0.3	V	I _C /I _B = -2.5mA / -0.25mA DDA143TU I _C /I _B = -1mA / -0.1mA DDA114TU I _C /I _B = -10mA / -1mA DDA113TU
DC Current Transfer Ratio	h _{FE}	100 160	250 —	600 —	—	I _C = -1mA, V _{CE} = -5V I _C = -1mA, V _{CE} = -5V DDA143TUQ
Input Resistor (R ₁) Tolerance	ΔR ₁	-30	—	+30	%	—
Gain-Bandwidth Product (Note 9)	f _T	—	250	—	MHz	V _{CE} = -10V, I _E = 5mA, f = 100MHz

Characteristic	Symbol	Min	Typ	Max	Unit	Test Condition	
Input Voltage	V _{I(OFF)}	DDA124EU	-0.5	-1.1	—	V	V _{CC} = -5V, I _O = -100μA
		DDA144EU	-0.5	-1.1			
DDA114YU		-0.3	—				
DDA123JU		-0.5	—				
DDA114EU		-0.5	-1.1				
Input Voltage	V _{I(ON)}	DDA124EU	—	-1.9	-3.0	V	V _O = -0.3, I _O = -5mA V _O = -0.3, I _O = -2mA V _O = -0.3, I _O = -1mA V _O = -0.3, I _O = -5mA V _O = -0.3, I _O = -10mA
		DDA144EU	—	-1.9	-3.0		
		DDA114YU	—	—	-1.4		
		DDA123JU	—	—	-1.1		
		DDA114EU	—	-1.9	-3.0		
Output Voltage	V _{O(ON)}	—	-0.1	-0.3	V	I _O /I _I = -10mA / -0.5mA I _O /I _I = -10mA / -0.5mA I _O /I _I = -5mA / -0.25mA I _O /I _I = -5mA / -0.25mA I _O /I _I = -10mA / -0.5mA	
Input Current	I _I	—	—	-0.36 -0.18 -0.88 -3.6 -0.88	mA	V _I = -5V	
Output Current	I _{O(OFF)}	—	—	-0.5	μA	V _{CC} = -50V, V _I = -0V	
DC Current Gain	G _I	56 60 68 68 80 30	—	—	—	V _O = -5V, I _O = -5mA V _O = -5V, I _O = -5mA V _O = -5V, I _O = -5mA V _O = -5V, I _O = -10mA V _O = -5V, I _O = -10mA V _O = -5V, I _O = -5mA	
Input Resistor (R ₁) Tolerance	ΔR ₁	-30	—	+30	%	—	
Resistance Ratio Tolerance	R ₂ /R ₁	-20	—	+20	%	—	
Gain-Bandwidth Product	f _T	—	250	—	MHz	V _{CE} = -10V, I _E = -5mA, f = 100MHz	

Note: 9. Transistor - For Reference Only.

Typical Curves – DDA123JU (@ $T_A = +25^\circ\text{C}$, unless otherwise specified.)

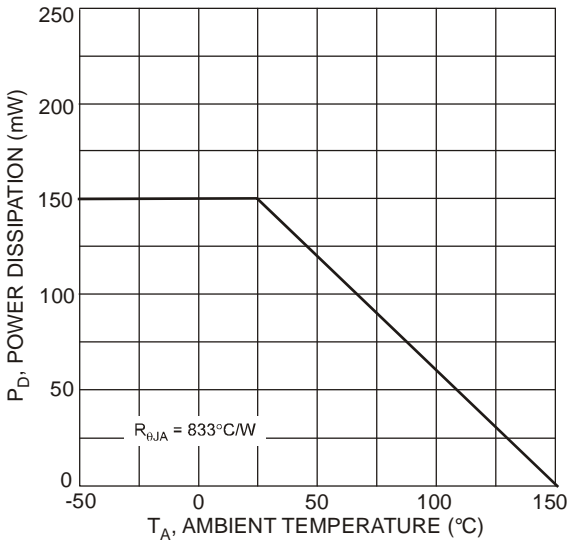

Fig. 1 Power Dissipation vs. Ambient Temperature

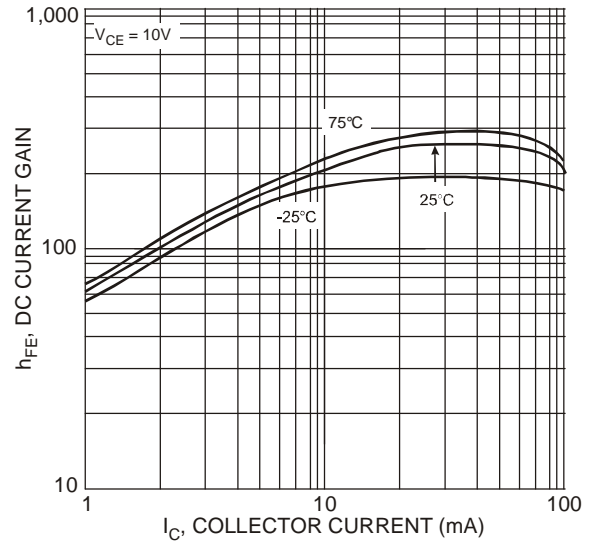

Fig. 2 Typical DC Current Gain vs. Collector Current

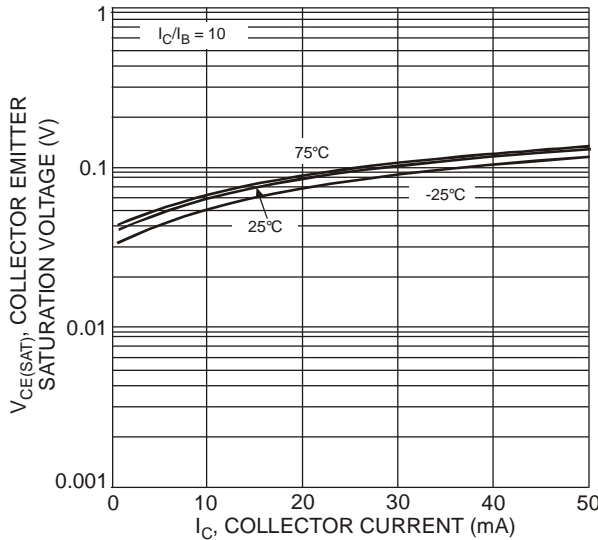

Fig. 3 Typical Collector Emitter Saturation Voltage vs. Collector Current

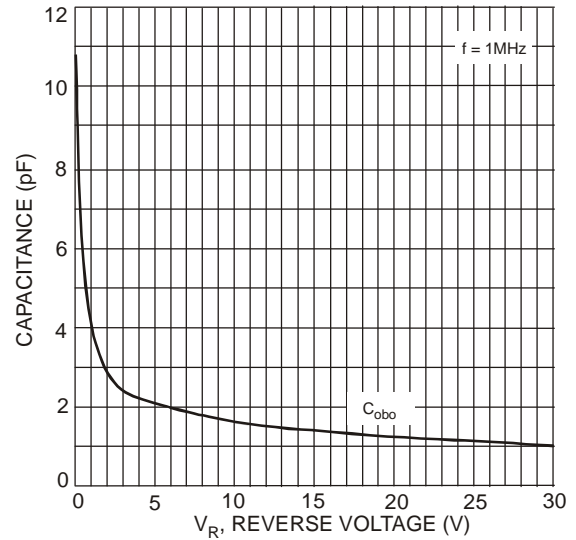

Fig. 4 Typical Capacitance Characteristics

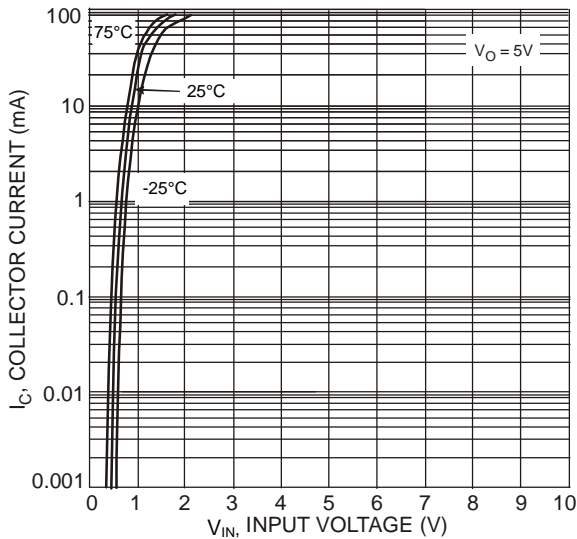

Fig. 5 Collector Current vs. Input Voltage

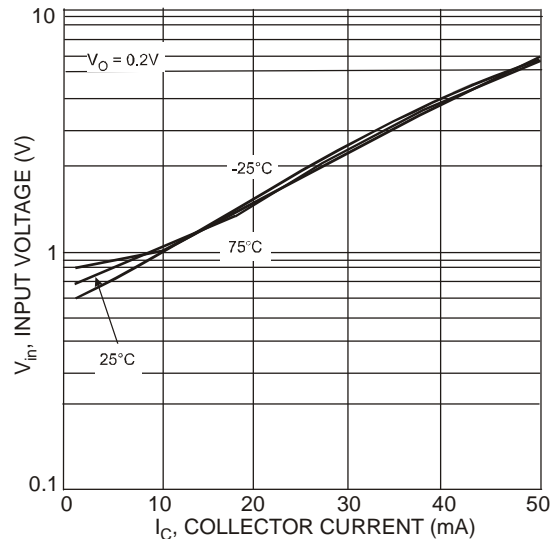

Fig. 6 Input Voltage vs. Collector Current

Typical Curves – DDA114TU (@ $T_A = +25^\circ\text{C}$, unless otherwise specified.)

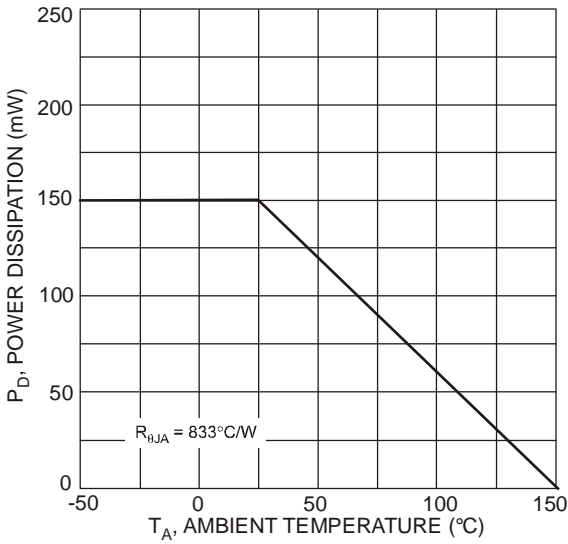

Fig.7 Power Dissipation vs. Ambient Temperature

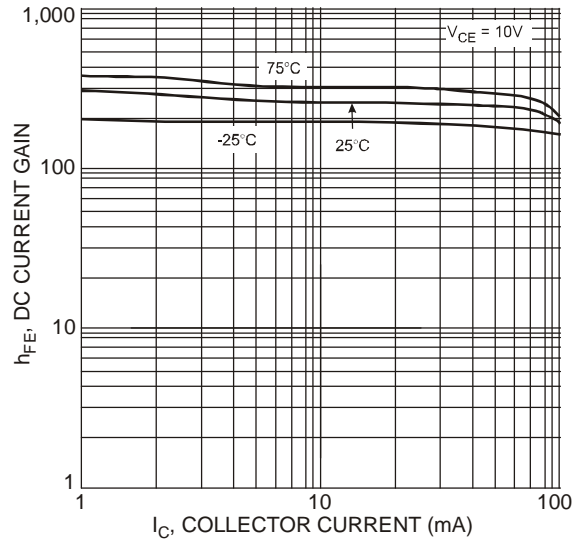

Fig.8 Typical DC Current Gain vs. Collector Current

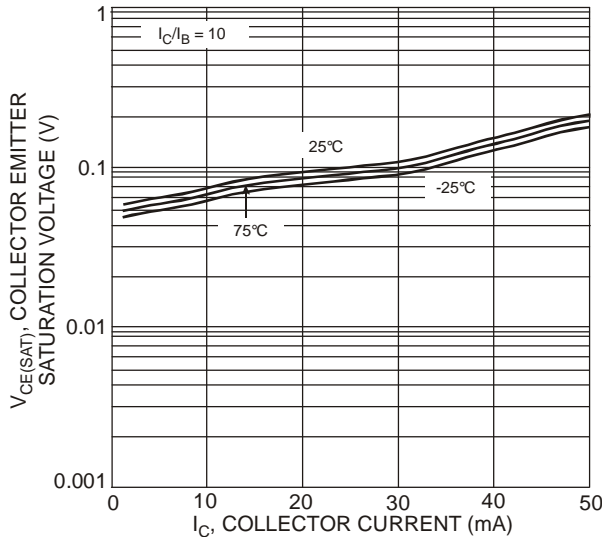

Fig.9 Typical Collector Emitter Saturation Voltage vs. Collector Current

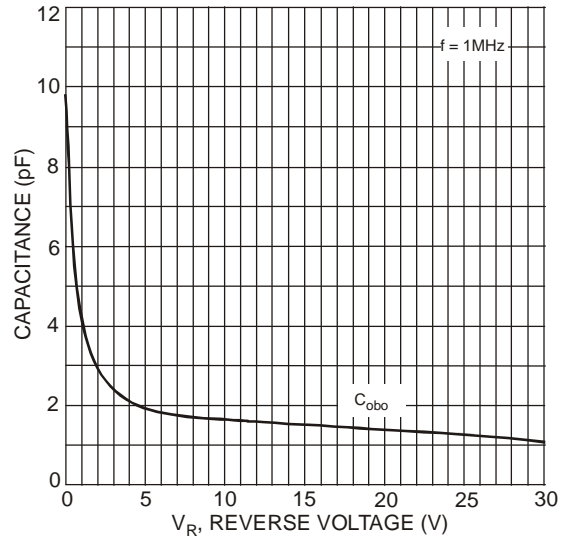

Fig.10 Typical Capacitance Characteristics

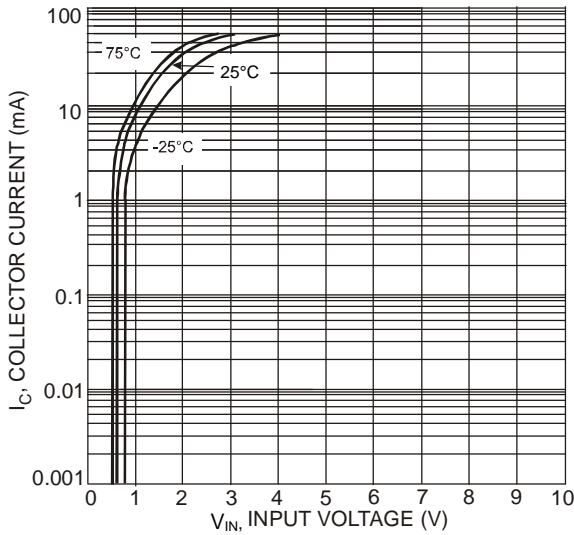

Fig.11 Collector Current vs. Input Voltage

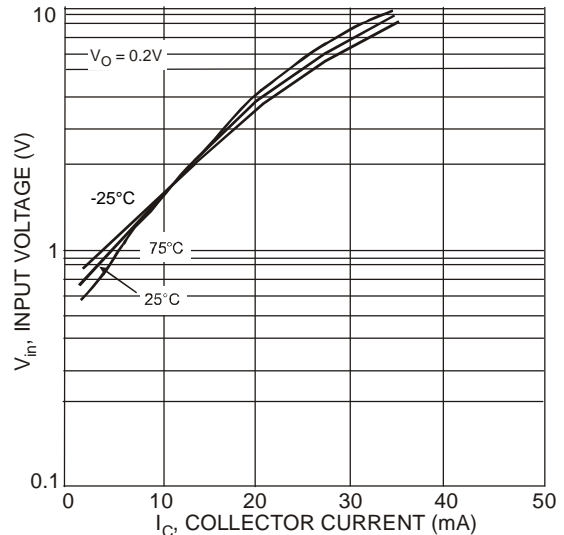
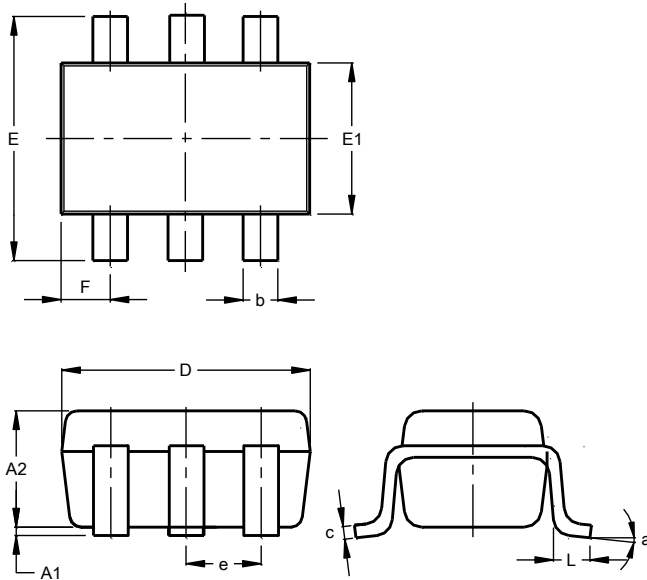

Fig.12 Input Voltage vs. Collector Current

Package Outline Dimensions

Please see <http://www.diodes.com/package-outlines.html> for the latest version.

SOT363



SOT363			
Dim	Min	Max	Typ
A1	0.00	0.10	0.05
A2	0.90	1.00	0.95
b	0.10	0.30	0.25
c	0.10	0.22	0.11
D	1.80	2.20	2.15
E	2.00	2.20	2.10
E1	1.15	1.35	1.30
e	0.650 BSC		
F	0.40	0.45	0.425
L	0.25	0.40	0.30
a	0°	8°	--
All Dimensions in mm			

Suggested Pad Layout

Please see <http://www.diodes.com/package-outlines.html> for the latest version.

SOT363

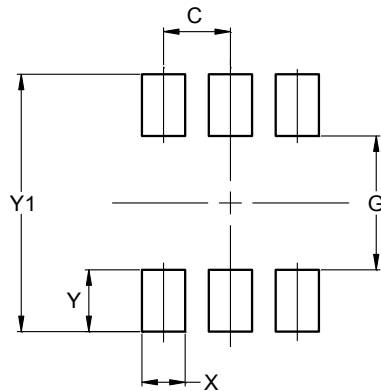

Dimensions	Value (in mm)
C	0.650
G	1.300
X	0.420
Y	0.600
Y1	2.500

IMPORTANT NOTICE

DIODES INCORPORATED MAKES NO WARRANTY OF ANY KIND, EXPRESS OR IMPLIED, WITH REGARDS TO THIS DOCUMENT, INCLUDING, BUT NOT LIMITED TO, THE IMPLIED WARRANTIES OF MERCHANTABILITY AND FITNESS FOR A PARTICULAR PURPOSE (AND THEIR EQUIVALENTS UNDER THE LAWS OF ANY JURISDICTION).

Diodes Incorporated and its subsidiaries reserve the right to make modifications, enhancements, improvements, corrections or other changes without further notice to this document and any product described herein. Diodes Incorporated does not assume any liability arising out of the application or use of this document or any product described herein; neither does Diodes Incorporated convey any license under its patent or trademark rights, nor the rights of others. Any Customer or user of this document or products described herein in such applications shall assume all risks of such use and will agree to hold Diodes Incorporated and all the companies whose products are represented on Diodes Incorporated website, harmless against all damages.

Diodes Incorporated does not warrant or accept any liability whatsoever in respect of any products purchased through unauthorized sales channel. Should Customers purchase or use Diodes Incorporated products for any unintended or unauthorized application, Customers shall indemnify and hold Diodes Incorporated and its representatives harmless against all claims, damages, expenses, and attorney fees arising out of, directly or indirectly, any claim of personal injury or death associated with such unintended or unauthorized application.

Products described herein may be covered by one or more United States, international or foreign patents pending. Product names and markings noted herein may also be covered by one or more United States, international or foreign trademarks.

This document is written in English but may be translated into multiple languages for reference. Only the English version of this document is the final and determinative format released by Diodes Incorporated.

LIFE SUPPORT

Diodes Incorporated products are specifically not authorized for use as critical components in life support devices or systems without the express written approval of the Chief Executive Officer of Diodes Incorporated. As used herein:

A. Life support devices or systems are devices or systems which:

1. are intended to implant into the body, or
2. support or sustain life and whose failure to perform when properly used in accordance with instructions for use provided in the labeling can be reasonably expected to result in significant injury to the user.

B. A critical component is any component in a life support device or system whose failure to perform can be reasonably expected to cause the failure of the life support device or to affect its safety or effectiveness.

Customers represent that they have all necessary expertise in the safety and regulatory ramifications of their life support devices or systems, and acknowledge and agree that they are solely responsible for all legal, regulatory and safety-related requirements concerning their products and any use of Diodes Incorporated products in such safety-critical, life support devices or systems, notwithstanding any devices- or systems-related information or support that may be provided by Diodes Incorporated. Further, Customers must fully indemnify Diodes Incorporated and its representatives against any damages arising out of the use of Diodes Incorporated products in such safety-critical, life support devices or systems.

Copyright © 2018, Diodes Incorporated

www.diodes.com

Mouser Electronics

Authorized Distributor

Click to View Pricing, Inventory, Delivery & Lifecycle Information:

Diodes Incorporated:

[DDA114YU-7-F](#) [DDA143TU-7-F](#) [DDA114EU-7-F](#) [DDA113TU-7-F](#) [DDA114TU-7-F](#) [DDA123JU-7-F](#) [DDA124EU-7-F](#)
[DDA144EU-7-F](#) [DDA114EUQ-7-F](#) [DDA114TUQ-13-F](#) [DDA114TUQ-7-F](#) [DDA114YUQ-7-F](#) [DDA124EUQ-13-F](#)
[DDA124EUQ-7-F](#) [DDA143TUQ-13-F](#) [DDA143TUQ-7-F](#) [DDA144EUQ-7-F](#)