

6.5Gbps 4-Lane SAS2/SATA/XAUI ReDriver™ with Equalization & De-emphasis

Features

- Up to 6.5Gbps SAS2/SATA/XAUI ReDriver™
- Supporting 8 differential channels or 4 lanes
- Independent channel configuration
- Pin strapped and I²C configuration controls (3.3V Tolerant)
- Adjustable receiver equalization
- Adjustable transmitter amplitude and de-emphasis
- Adjustable input threshold level
- 50-Ohm input/output termination
- Mux/Demux and loop-back features
- OOB fully supported
- Single supply voltage, 1.2V ± 5%
- Active Current per channel - 95mA (typical)
- Automatic slumber mode power savings
 - Slumber current per channel -10mA (typical)
- Power down Standby Mode
 - Standby current -1mA (typical)
- Industrial temperature range: -40°C to 85°C
- Packaging (Pb-free & Green):
 - 100-contact LPGA (11mm x11mm)

Description

Diodes' PI2EQX6814 is a 6.5Gbps low power, 4 lane (8 channel) SAS2, SATA, XAUI signal ReDriver™. The device provides programmable equalization, amplification, and de-emphasis by either pin strapping or I²C control, select bits, to optimize performance over a variety of physical mediums by reducing Inter-symbol interference.

PI2EQX6814 supports eight 100-Ohm Differential CML data I/O's between the Protocol ASIC to a switch fabric, across a back-plane, or extends the signals across other distant data pathways on the user's platform.

The integrated equalization circuitry provides flexibility with signal integrity of the signal before the ReDriver, whereas the integrated de-emphasis circuitry provides flexibility with signal integrity of the signal after the ReDriver.

In addition to providing signal re-conditioning, Diodes' PI2EQX6814 also provides power management Stand-by mode operated by a Power Down pin, or through I²C register.

In addition, the device performs automatic Slumber Mode (Disable Transmit) during idle conditions on the receiver.

Block Diagram

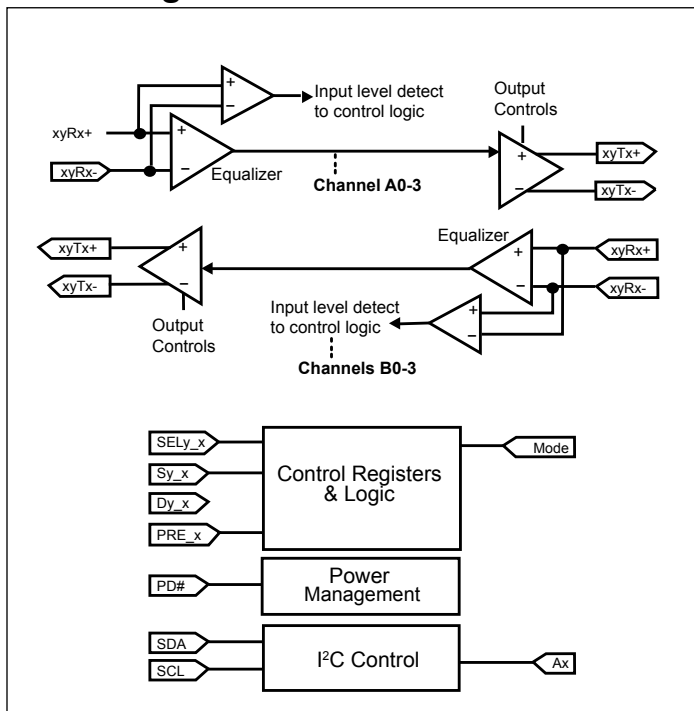

Pin Configuration (Top-Side View)

	1	2	3	4	5	6	7	8	9	10
A	VDD	B0TX-	B0TX+	VDD	SCL	SDA	VDD	B0RX+	B0RX-	VDD
B	A1RX+	GND	GND	A0RX-	DE_A	VDD	A0TX-	GND	GND	A1TX+
C	A1RX-	GND	GND	A0RX+	NC	PD#	A0TX+	GND	GND	A1TX-
D	VDD	B1TX+	B1TX-	VDD	D2_A	GND	VDD	B1RX-	B1RX+	VDD
E	SEL0_A	SEL1_A	SEL2_A	GND	D1_A	S0_A	NC	S1_A	SIG_A	NC
F	NC	SIG_B	S1_B	NC	S0_B	A1	SEL2_B	LB#	SEL1_B	SEL0_B
G	VDD	A2RX-	A2RX+	VDD	MODE	GND	VDD	A2TX+	A2TX-	VDD
H	B2TX+	GND	GND	B3TX-	DE_B	A0	B3RX-	GND	GND	B2RX+
J	B2TX-	GND	GND	B3TX+	NC	D1_B	B3RX+	GND	GND	B2RX-
K	VDD	A3RX+	A3RX-	VDD	D2_B	A4	VDD	A3TX-	A3TX+	VDD

Pin Description

Pin #	Pin Name	Type	Description
Data Signals			
C4 B4	A0RX+, A0RX-	I I	CML inputs for Channel A0, with internal 50-Ohm pull-down. Goes to high-impedance during power-down (PD#=0).
C7 B7	A0TX+, A0TX-	O O	CML outputs for Channel A0, with internal 50-Ohm pull-up. Goes to high-impedance during power-down (PD#=0).
B1 C1	A1RX+, A1RX-	I I	CML inputs for Channel A1, with internal 50-Ohm pull-down. Goes to high-impedance during power-down (PD#=0).
B10 C10	A1TX+, A1TX-	O O	CML outputs for Channel A1, with internal 50-Ohm pull-up. Goes to high-impedance during power-down (PD#=0).
G3 G2	A2RX+, A2RX-	I I	CML inputs for Channel A2, with internal 50-Ohm pull-down. Goes to high-impedance during power-down (PD#=0).
G8 G9	A2TX+, A2TX-	O O	CML outputs for Channel A2, with internal 50-Ohm pull-up. Goes to high-impedance during power-down (PD#=0).
K2 K3	A3RX+, A3RX-	I I	CML inputs for Channel A3 with internal 50-Ohm pull-down. Goes to high-impedance during power-down (PD#=0).
K9 K8	A3TX+, A3TX-	O O	CML outputs for Channel A3, with internal 50-Ohm pull-up. Goes to high-impedance during power-down (PD#=0).
A8 A9	B0RX+, B0RX-	I I	CML inputs for Channel B0, with internal 50-Ohm pull-down. Goes to high-impedance during power-down (PD#=0).
A3 A2	B0TX+, B0TX-	O O	CML outputs for Channel B0, with internal 50-Ohm pull-up. Goes to high-impedance during power-down (PD#=0).
D9 D8	B1RX+, B1RX-	I I	CML inputs for Channel B1, with internal 50-Ohm pull-down. Goes to high-impedance during power-down (PD#=0).
D2 D3	B1TX+, B1TX-	O O	CML outputs for Channel B1, with internal 50-Ohm pull-up. Goes to high-impedance during power-down (PD#=0).
H10 J10	B2RX+, B2RX-	I I	CML inputs for Channel B2, with internal 50-Ohm pull-down. Goes to high-impedance during power-down (PD#=0).
H1 J1	B2TX+, B2TX-	O O	CML outputs for Channel B2, with internal 50-Ohm pull-up. Goes to high-impedance during power-down (PD#=0).
J7 H7	B3RX+, B3RX-	I I	CML inputs for Channel B3, with internal 50-Ohm pull-down. Goes to high-impedance during power-down (PD#=0).
J4 H4	B3TX+, B3TX-	O O	CML outputs for Channel B3, with internal 50-Ohm pull-up. Goes to high-impedance during power-down (PD#=0).
Control Signals			
H6, F6, K6	A0, A1, A4	I	I ² C programmable address bit A0, A1 and A4 with 100K-Ohm internal pull up
E5 D5	D1_A D2_A	I	Selection pins for Channel Ax de-emphasis (See de-emphasis Configuration Table) w/ 100K-Ohm internal pull up

Pin #	Pin Name	Type	Description
J6 K5	D1_B D2_B	I	Selection pins for Channel Bx de-emphasis (See de-emphasis Configuration Table) w/ 100K-Ohm internal pull up
B5	DE_A	I	De-emphasis enable input for Channel A0, A1, A2 and A3 with internal 100K-Ohm pull-up resistor. Set high selects output pre-de-emphasis and set low selects output de-emphasis.
H5	DE_B	I	De-emphasis enable input for Channel B0, B1, B2 and B3 with internal 100K-Ohm pull-up resistor. Set high selects output pre-de-emphasis and set low selects output de-emphasis.
F8	LB#	I	Input with internal 100K-Ohm pull-up resistor. LB# = High or open for normal operation. LB# = Low for loopback connection of A_RX to A_TX and B_TX.
G5	MODE	I	Input switch between pin control and I ² C control with internal 100k-ohm pull-up resistor. A LVCMOS high level selects input pin control, and disables I ² C operation. Note, during startup, input status of the control pin (LB#, PD#, SEL0-2_A/B, D1-2_A/B, S0-1_A/B, DE_A/B) will be latched to the initial state of some I ² C control bits only once.
C5, E7, E10, F1, F4, J5	NC		Do Not Connect (Reserved for future use.)
C6	PD#	I	Input with internal 100K-Ohm pull-up resistor, PD# =High or open is normal operation, PD# =Low disable the IC, and set IC to power down mode, both input and output go Hi-Z.
E6 E8	S0_A S1_A	I	Selection pins for Channel Ax output level (see Output Swing Configuration Table) w/ 100K-Ohm internal pull up
F5 F3	S0_B S1_B	I	Selection pins for Channel Bx output level (see Output Swing Configuration Table) w/ 100K-Ohm internal pull up
A5	SCL	I	I ² C SCL clock input. Up to 3.3V input tolerance.
A6	SDA	I/O	I ² C SDA data input/output. Up to 3.3V input tolerance
E1, E2, E3	SEL[0:2]_A	I	Selection pins for Channel Ax Equalization (see Equalizer Configuration Table) w/ 100K-Ohm internal pull up
F10, F9, F7	SEL[0:2]_B	I	Selection pins for Channel Bx Equalization (see Equalizer Configuration Table) w/ 100K-Ohm internal pull up
E9	SIG_A	O	Signal detect output pin for Channel A0. SIG_A=High represents a input signal > threshold at the differential inputs.
F2	SIG_B	O	Signal detect output pin for Channel B0. SIG_B=High represents a input signal > threshold at the differential inputs.
Power Pins			
B2, B3, B8, B9, C2, C3, C8, C9, D6, E4, G6, H2, H3, H8, H9, J2, J3, J8, J9	GND	PWR	Supply Ground
A1, A4, A7, A10, B6, D1, D4, D7, D10, G1, G4, G7, G10, K1, K4, K7, K10	V _{DD}	PWR	1.2V Supply Voltage

Description of Operation

Configuration Modes

Device configuration can be performed in two ways depending on the state of the MODE input. MODE determines whether IC configuration is from the input pins or via I²C control. Note that the MODE pin is not latched, and is always active to enable or disable I²C access. When MODE is set high, the configuration input pins determine the configuration operating state and changes to the input configuration pins will change the operating mode.

When the MODE pin is low, programming of all control registers via I²C is allowed. During initial power-on, the value at the configuration input pins: LB#, PD#, DE_A, DE_B, SEL0_A, SEL1_A, SEL2_A, D1_A, D2_A, S0_A, S1_A, SEL0_B, SEL1_B, SEL2_B, D1_B, D2_B, S0_B, S1_B, will be latched to the configuration registers as initial startup states.

Equalizer Configuration

The PI2EQX6814 input equalizer compensates for signal attenuation and Inter-Symbol Interference (ISI) resulting from long signal traces or cables, vias, signal crosstalk and other factors, by boosting the gain of high-frequency signal components. Because either too little, or too much, signal compensation may be non-optimal eight levels are provided to adjust for any application.

Equalizer configuration is performed in two ways determined by the state of the MODE pin. In MODE=1 (Input pin control), each group of 4 channels, A and B, has separate equalization control, and all four channels within the group are assigned the same configuration state through SELx_[A:B] input pins. In MODE=0 (I2C control), individual channel equalizer configuration can be controlled independently. The Equalizer selection table below describes pin strapping options and associated operation of the equalizer. Refer to the section on I2C programming for information on software configuration of the equalizer.

Equalizer Selection

SEL2_[A:B]	SEL1_[A:B]	SEL0_[A:B]	@1.5GHz	@3.0GHz
0	0	0	0.8dB	1.5dB
0	0	1	1.0dB	1.9dB
0	1	0	1.5dB	3.2dB
0	1	1	2.5dB	5.2dB
1	0	0	3.5dB	6.9dB
1	0	1	4.4dB	8.3dB
1	1	0	5.9dB	10.4dB
1	1	1	8.7dB	13.8dB

Output Configuration

The PI2EQX6814 provides flexible output swing and de-emphasis controls to provide the optimum signal to pre-compensate for losses across long trace or noisy environments so that the receiver gets a clean eye opening. In MODE = I (Input pin Control), Control of output configuration is grouped for the A and B channels, so that each channel within the group has the same setting. In MODE = 0 (I²C control), each channel is independently controlled for output swing and output de-emphasis.

Output Swing Control

When the device first powers up, the S[1:0]_X = 00 is set. If the MODE pin is low, reprogramming of these control registers Bit 2 and 1 of Byte 5,6, 7, 8, 9, 10, 11,12 control register via I²C is allowed on a per channel basis.

S1_[A:B]	S0_[A:B]	Swing (Differential)
0	0	1.1V (Available for Pin Strap only)
0	1	0.5V
1	0	0.8V
1	1	1.0V

The Output Swing Control table shows available configuration settings for output level control, as specified using registers. Output swing settings are independent of the data rate.

Output De-emphasis Width Adjustment

De-emphasis settings are determined by the state of the configuration registers (Bits 4, 3 of control Registers 5, 6, 7, 8, 9, 10, 11, 12) or pins D1_A, D2_A, D1_B, D2_B, as shown in the Output De-emphasis Adjustment table below. De-emphasis-half-bit is selected as the default power-on mode, but can be changed to De-emphasis-full-bit via reprogramming the Loopback and De-emphasis Control register (Bit 2 and 3 of Byte 2) using the I²C interface. Output De-emphasis settings are independent of the data rate.

Output De-emphasis Adjustment

D2_[A:B]	D1_[A:B]	De-emphasis
0	0	0dB
0	1	3.5dB
1	0	5.5dB
1	1	7.5dB

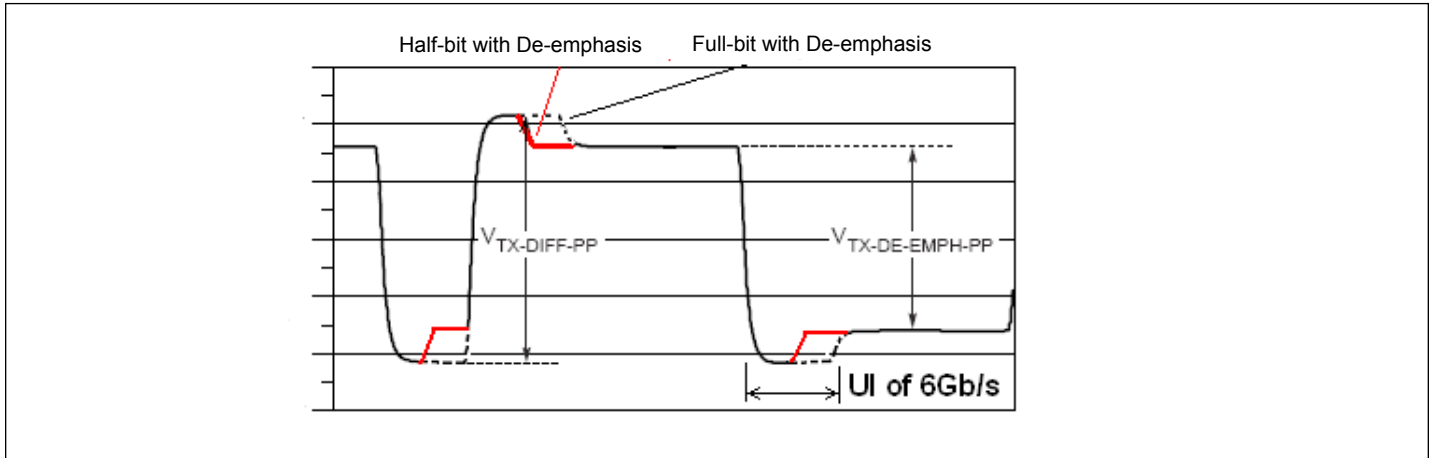

Choice of half-bit or full-bit de-emphasis depends on the need for more de-emphasis (longer trace) or less de-emphasis (shorter trace) respectively.

Input Level Detect

An input level detect and output squelch function is provided on each channel to eliminate re-transmission of input noise. A continuous signal level below the V_{th} threshold causes the output driver to drive both the plus and minus signal pair to the common mode voltage.

The input sensitivity can be adjusted via the input level threshold register for special requirements.

Input Threshold Configuration

Bit	Threshold (mVppd)
7	180
6	160
5	140
4	120 (Default)
3	100
2	80
1	60
0	40

Loopback Operation

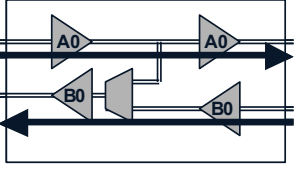
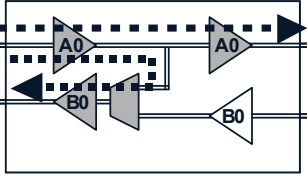
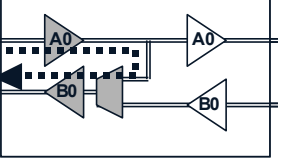
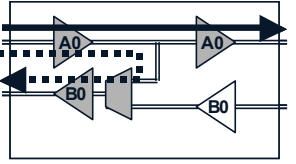
Loopback Modes	CONDITIONS
 <p>NORMAL MODE A0Rx to A0Tx, B0Rx to B0Tx</p>	<p>LB_A0B0# = 1 INDIS_A0 = 0 OUTDIS_A0 = 0 INDIS_B0 = 0 OUTDIS_B0 = 0</p>
 <p>BROADCAST MODE A0Rx to A0Tx and B0Tx</p>	<p>LB_A0B0# = 0 INDIS_A0 = 0 OUTDIS_A0 = 0 INDIS_B0 = 1 OUTDIS_B0 = 0</p>
 <p>LOOPBACK MODE A0Rx to B0Tx</p>	<p>LB_A0B0# = 0 INDIS_A0 = 0 OUTDIS_A0 = 1 INDIS_B0 = 1 OUTDIS_B0 = 0</p>
 <p>DEMUX MODE Solid Line A0Rx to A0Tx</p> <p>DEMUX MODE Dashed Line A0Rx to B0Tx</p>	<p>LB_A0B0# = 1 INDIS_A0 = 0 OUTDIS_A0 = 0 INDIS_B0 = 1 OUTDIS_B0 = 1</p> <p>LB_A0B0# = 0 INDIS_A0 = 0 OUTDIS_A0 = 1 INDIS_B0 = 1 OUTDIS_B0 = 0</p>
	<p>MUX MODE Solid Line B0Rx to B0Tx</p> <p>MUX MODE Dashed Line A0Rx to B0Tx</p>

Each lane provides a loopback mode for test purposes which is controlled by a strapping pin and I²C register bit. The LB# pin controls all lanes together. When this pin is high normal data mode is enabled. When LB# is low the loopback feature is enabled. The adjacent figure diagrams this operation. Loopback is not intended to be dynamically switched, and the normal system application is to initialize to one configuration or the other.

The Loopback mode can also support mux/demux operation. Using I²C configuration, unused inputs and outputs can be disabled to minimize power and noise.

I²C Operation

The integrated I²C interface operates as a slave device, supporting standard rate operation of 100Kbps, with 7-bit addressing mode. The data byte format is 8 bit bytes, and supports the format of indexing to be compatible with other bus devices. The index, or dummy byte will have no effect on the PI2EQX6814 operation. The bytes must be accessed in sequential order from the lowest to the highest byte with the ability to stop after any complete byte has been transferred. Address bits A4, A1 and A0 are programmable to support multiple chips environment. The Data is loaded until a Stop sequence is issued.

Note that the I²C inputs, SCL and SDA operate at 1.2V logic levels, and are 3.3V tolerant.

Configuration Register Summary

Byte	Mnemonic	Function
0	SIG	Signal Detect, indicates valid input signal level
1	RSVD	Reserved for future use
2	LBEC	Loopback and De-emphasis Control, provides for control of the loopback function and de-emphasis mode (pre-de-emphasis or de-emphasis)
3	INDIS	Channel Input Disable, controls whether s channels input buffer is enabled or disabled
4	OUTDIS	Channel Output Disable, controls whether a channel output buffer is enabled or disabled.
5	A0	Channel A0 configuration
6	B0	Channel B0 configuration
7	A1	Channel A1 configuration
8	B1	Channel B1 configuration
9	A2	Channel A2 configuration
10	B2	Channel B2 configuration
11	A3	Channel A3 configuration
12	B3	Channel B3 configuration
13	VTH	Input level threshold configuration
14	RSVD	Reserved for future use

Register Description

BYTE 0 - Signal Detect (SIG)

SIG_{xy}=0=low input signal, SIG_{xy}=1=valid input signal

Bit	7	6	5	4	3	2	1	0
Name	SIG_A0	SIG_B0	SIG_A1	SIG_B1	SIG_A2	SIG_B2	SIG_A3	SIG_B3
Type	R	R	R	R	R	R	R	R
Power-on State	X	X	X	X	X	X	X	X

Note: R=Read only, W=Write only, R/W=Read and Write, X=Undefined, rsvd=reserved for future use

The Signal Detect register provides information on the instantaneous status of the channel input from the Input Level Threshold Detect circuit. If the input level falls below the V_{th}- level the relevant SIG_{xy} bit will be 0, indicating a low-level noise or electrical idle input, resulting in the outputs going to the high-impedance off state or squelch mode. If the input level is above V_{th}-, then SIG_{xy} is 1, indicating a valid input signal, and active signal recovery operation.

BYTE 1 - Reserved

Reserved Byte 1 is visible via the I²C interface. This is a read-only byte with an undefined initial state after power-up. This byte is reserved for future use.

BYTE 2 - Loopback and De-emphasis Control Register (LBEC)

LB_{xyxy}#=0=loopback mode, LB_{xyxy}#=1=normal mode,

Slumber = 1 = auto-power down slumber enabled,

Slumber = 0 = auto power down disabled

DE_x = 0 Full-bit de-emphasis, DE_x = 1 Half-bit de-emphasis,

Bit	7	6	5	4	3	2	1	0
Name	LB_A0B0#	LB_A1B1#	LB_A2B2#	LB_A3B3#	DE_A	DE_B	Slumber	Bypass
Type	R/W	R/W	R/W	R/W	R/W	R/W	R/W	R/W
Power-on State	LB#	LB#	LB#	LB#	DE_A	DE_B	1	0

Note: R=Read only, W=Write only, R/W=Read and Write, X=Undefined, rsvd=reserved for future use

Individual control for each lane is provided for the loopback function via this register. Slumber mode, auto power down for all channels is enabled by slumber. For details on Full-bit de-emphasis and Half-bit de-emphasis, refer to Output De-emphasis Width Adjustment section description. Bypass is for IC manufacturing test only, and should always be set to "0" for normal operation.

BYTE 3 - Channel Input Disable (INDIS)

INDIS_{xy}=0=enable input, INDIS_{xy}=1=disable input

Bit	7	6	5	4	3	2	1	0
Name	INDIS_A0	INDIS_B0	INDIS_A1	INDIS_B1	INDIS_A2	INDIS_B2	INDIS_A3	INDIS_B3
Type	R/W	R/W	R/W	R/W	R/W	R/W	R/W	R/W
Power-on State	0	0	0	0	0	0	0	0

Note: R=Read only, W=Write only, R/W=Read and Write, X=Undefined, rsvd=reserved for future use

The Channel Input Disable register, provides control over the input buffer of each channel independently. When an INDIS_{xy} bit is logic 1, then the input buffer is switched off and the input termination is high impedance. This feature can be used for PCB testing, and when only one input is used during Loopback as a demux function. When INDIS_{xy} is at a logic 0 state then the input buffer is enabled (normal operating mode).

BYTE 4 - Channel Output Disable (OUTDIS)

ODIS_{xy}=0=enable output, ODIS_{xy}=1=disable output

Bit	7	6	5	4	3	2	1	0
Name	ODIS_A0	ODIS_B0	ODIS_A1	ODIS_B1	ODIS_A2	ODIS_B2	ODIS_A3	ODIS_B3
Type	R/W	R/W	R/W	R/W	R/W	R/W	R/W	R/W
Power-on State	0	0	0	0	0	0	0	0

Note: R=Read only, W=Write only, R/W=Read and Write, X=Undefined, rsvd=reserved for future use

The Channel Output Disable register, allows control over the output buffer of each channel independently. When an OUTDIS_{xy} bit is logic 1, then the output buffer is switched off and the termination is high impedance. This feature can be used for PCB testing, and when only one output is used during Loopback as a mux function. When INDIS_{xy} is at a logic 0 state then the input buffer is enabled (normal operating mode).

- BYTE 5 - A0 Channel Configuration**
- BYTE 6 - B0 Channel Configuration**
- BYTE 7 - A1 Channel Configuration**
- BYTE 8 - B1 Channel Configuration**
- BYTE 9 - A2 Channel Configuration**
- BYTE 10 - B2 Channel Configuration**
- BYTE 11 - A3 Channel Configuration**

BYTE 12 - B3 Channel Configuration

SEL_x_B: Equalizer configuration (see Equalizer Configuration Table)
 Dx_B: De-emphasis control (see De-emphasis Configuration Table)
 Sx_B: Output level control (see Output Swing Configuration Table)

Bit	7	6	5	4	3	2	1	0
Name	SEL0_XX	SEL1_XX	SEL2_XX	D1_XX	D2_XX	S0_XX	S1_XX	PD#
Type	R/W	R/W	R/W	R/W	R/W	R/W	R/W	R/W
Power-on State	SEL0_XX	SEL1_XX	SEL2_XX	D1_XX	D2_XX	S0_XX	S1_XX	PD#

Note: R=Read only, W=Write only, R/W=Read and Write, X=Undefined, rsvd=reserved for future use

The Ax/Bx-Channel configuration registers are used to control the input equalizer and output de-emphasis, swing levels and power-down. These register bits are loaded from the input configuration pins of the same name at power-on. These bits may be changed if the PGM# input is set low to allow I²C configuration. Please refer to the tables (1) Equalizer Configuration, (2) Output Swing Configuration and (3) Output De-emphasis Configuration earlier in this document for setting information.

BYTE 13 - Input Level Threshold Configuration

Bit	7	6	5	4	3	2	1	0
Name	VTH7	VTH6	VTH5	VTH4	VTH3	VTH2	VTH1	VTH0
Type	R/W	R/W	R/W	R/W	R/W	R/W	R/W	R/W
Power-on State	1	1	1	0	1	1	1	1

Note:
 R=Read only, W=Write only, R/W=Read and Write, X=Undefined, rsvd=reserved for future use
 Only 1 bit can be enabled at a time
 0 = enable level, 1 = disable level,
 Refer to Input Threshold Table for configuration information.

BYTE 14 - Reserved

Reserved Byte 14 is visible via the I²C interface. This byte is R/W, is in an undefined state at power up, and should not be changed for normal operation.

Transferring Data

Every byte put on the SDA line must be 8-bits long. Each byte has to be followed by an acknowledge bit. Data is transferred with the most significant bit (MSB) first (see the I²C Data Transfer diagram). The PI2EQX6814 will never hold the clock line SCL LOW to force the master into a wait state.

Note: Byte-write and byte-read transfers have a fixed offset of 0x00, because of the very small number of configuration bytes. An offset byte presented by a host to the PI2EQX6814 is not used.

Addressing

Up to eight PI2EQX6814 devices can be connected to a single I²C bus. The PI2EQX6814 supports 7-bit addressing, with the LSB indicating either a read or write operation. The address for a specific device is determined by the A0, A1 and A4 input pins.

Address Assignment							
A6	A5	A4	A3	A2	A1	A0	R/W
1	1	Program	0	0	Programmable		1=R, 0=W

Acknowledge

Data transfer with acknowledge is required from the master. When the master releases the SDA line (HIGH) during the acknowledge clock pulse, the PI2EQX6814 will pull down the SDA line during the acknowledge clock pulse so that it remains stable LOW during the HIGH period of this clock pulse as indicated in the I²C Data Transfer diagram. The PI2EQX6814 will generate an acknowledge after each byte has been received.

Data Transfer

A data transfer cycle begins with the master issuing a start bit. After recognizing a start bit, the PI2EQX6814 will watch the next byte of information for a match with its address setting. When a match is found it will respond with a read or write of data on the following clocks. Each byte must be followed by an acknowledge bit, except for the last byte of a read cycle which ends with a stop bit. For a write cycle, the first data byte following the address byte is a dummy or fill byte that is not used by the PI2EQX6814. This byte is provided to provided compatibility with systems implementing 10-bit addressing. Data is transferred with the most significant bit (MSB) first.

I²C Data Transfer

Start & Stop Conditions

A HIGH to LOW transition on the SDA line while SCL is HIGH indicates a START condition. A LOW to HIGH transition on the SDA line while SCL is HIGH defines a STOP condition, as shown in the figure below.

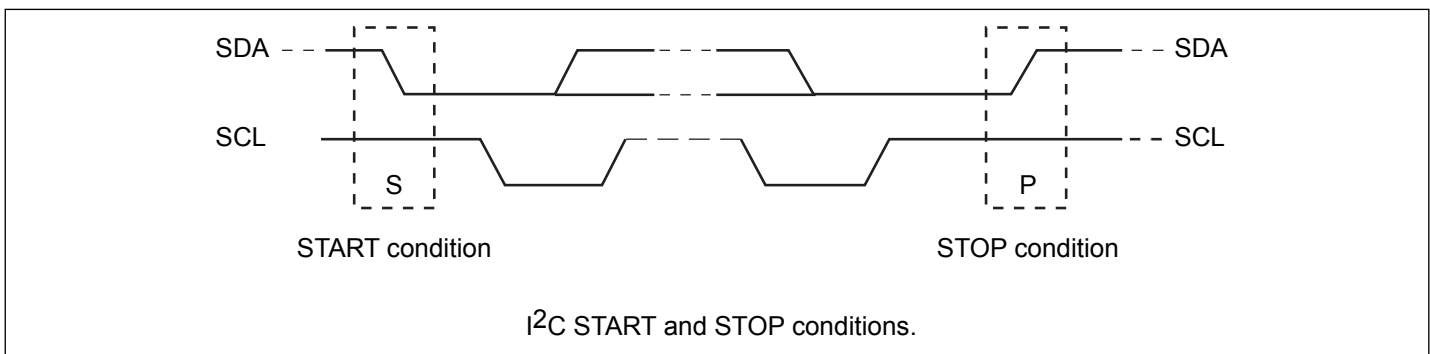

I²C Data Transfer

1. Read sequence

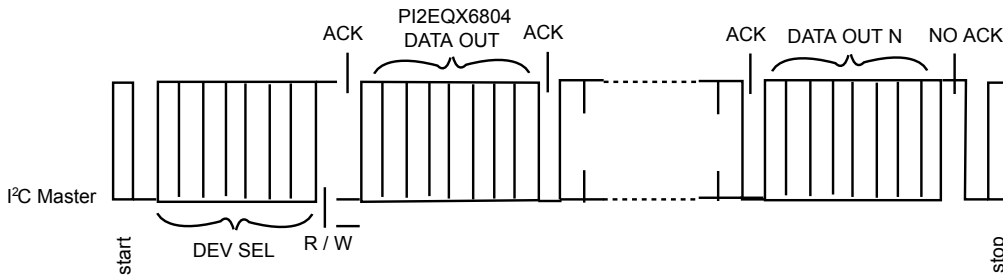

2. Write sequence

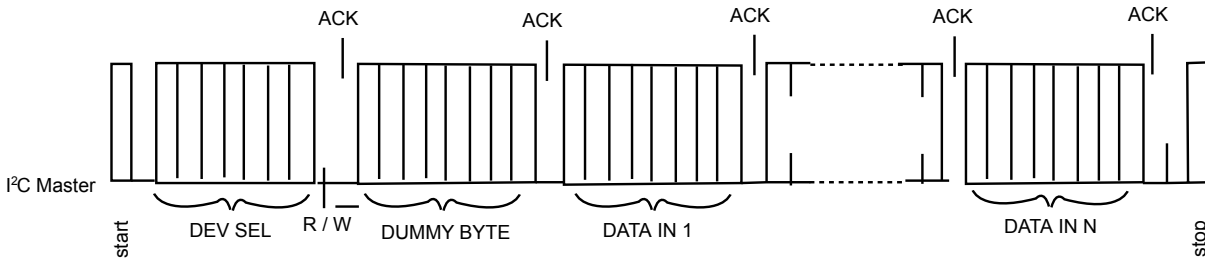

3. Combined sequence

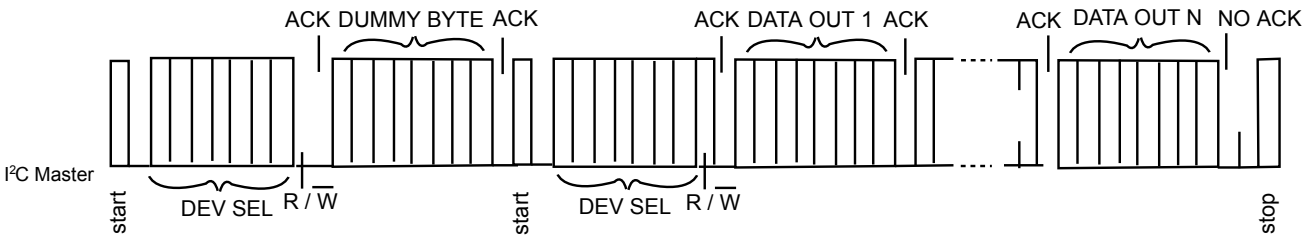

Notes:

1. only block read and block write from the lowest byte are supported for this application.
2. for some I²C application, an offset address byte will be presented at the second byte in write command, which is called dummy byte here and will be simply ignored in this application for correct interoperation.

Maximum Ratings

(Above which useful life may be impaired. For user guidelines, not tested.)

Storage Temperature	-65°C to +150°C
Supply Voltage to Ground Potential	-0.5V to +1.45V
DC SIG Voltage	-0.5V to VDD +0.5V
Output Current	-25mA to +25mA
Power Dissipation Continuous	1W
Operating Temperature	-40 to +85°C
ESD, HBM,	-2kV to +2kV

Note:

Stresses greater than those listed under MAXIMUM RATINGS may cause permanent damage to the device. This is a stress rating only and functional operation of the device at these or any other conditions above those indicated in the operational sections of this specification is not implied. Exposure to absolute maximum rating conditions for extended periods may affect reliability.

AC/DC Electrical Characteristics

Power Supply Characteristics ($V_{DD} = 1.2V \pm 5\%$, $T_A = -40 TO 85^\circ C$)

Symbol	Parameter	Conditions	Min.	Typ.	Max.	Units
$I_{DDactive}$	Power supply current - active	All channels switching @ 6.5 Gbps			900	mA
$I_{DDstandby}$	Power supply current - standby	PD# = 0		1	5	
$I_{DDslumber}$	Power supply current - per channel, Slumber			10		
$I_{DD-channel}$	Power supply current - per channel, Active			95		

AC Performance Characteristics ($V_{DD} = 1.2V \pm 5\%$, $T_A = -40 TO 85^\circ C$)

Symbol	Parameter	Conditions	Min.	Typ.	Max.	Units
T_{pd}	Channel latency from input to output			750		ps

CML Receiver Input ($V_{DD} = 1.2V \pm 5\%$, $T_A = -40$ TO $85^\circ C$)

Symbol	Parameter	Conditions	Min.	Typ.	Max.	Units
CML Receiver Input						
Z_{RX-DC}	DC Input Impedance		40			Ohm
$Z_{RX-DIFF-DC}$	DC Differential Input Impedance		85	100	115	
$V_{RX-DIFFP-P}$	Differential Input Peak-to-peak Voltage		240		1000	mV
$V_{RX-CM-ACP}$	AC Peak Common Mode Input Voltage				100	
V_{TH-SD}	OOB Signal detect input Threshold		75		200 ⁽¹⁾	mVppd
Equalization						
T_J	Total Jitter	Measured at 6Gbps/500			0.37	Ulp-p
D_J	Deterministic Jitter	Measured at 6Gbps/500			0.19	psrms

Note:

- Using Compliance test at 1.5Gbps and 3Gbps. Also using OOB (OOB is formed by ALIGNp primitive or D24.3) test patterns at 1.5Gbps. The ALIGN primitive (K28.5+D10.2+D27.3 = 0011111010+0101010101+0010011100). The D24.3 = 00110011001100110011

CML Transmitter Output ($V_{DD} = 1.2V \pm 5\%$, $T_A = -40$ TO $85^\circ C$)

Symbol	Parameter	Conditions	Min.	Typ.	Max.	Units
$Z_{TX-DIFF-DC}$	DC Differential TX Impedance		80	100	120	Ohms
$V_{TX-DIFFP-P0}$	Differential Peak-to-peak Output Voltage $V_{TX-DIFFP-P} = 2 * V_{TX-D+} - V_{TX-D-} $	S[1:0] = 00, 0dB de-emphasis	0.9	1.1	1.3	V
		S[1:0] = 01, 0dB de-emphasis	0.3	0.5	0.7	
		S[1:0] = 10, 0dB de-emphasis	0.6	0.8	1	
		S[1:0] = 11, 0dB de-emphasis	0.8	1	1.2	
V_{TX-C}	Common-Mode Voltage $ V_{TX-D+} + V_{TX-D-} / 2$			$V_{DD} - 0.6$		V
t_F, t_R	Transition Time	20% to 80%			150	ps
$t_F - t_R$	Mismatch Transition Time	@3Gbps			35	%
V_{amp_bal}	TX amplitude imbalance	@3Gbps			10	
T_{skew}	TX differential skew				20	ps
V_{cm_ac}	TX AC common mode voltage	@3Gbps			50	mVpp
V_{cmOOB}	OOB common mode delta voltage				50	mV
$V_{diffOOB}$	OOB differential delta voltage				25	

Digital I/O DC Specifications ($V_{DD} = 1.2V \pm 5\%$, $T_A = -40$ TO $85^\circ C$)

Symbol	Parameter	Conditions	Min.	Typ.	Max.	Units
V_{IH}	DC input logic high		$V_{DD}/2 + 0.2$		$V_{DD} + 0.3$	V
V_{IL}	DC input logic low		-0.3		$V_{DD}/2 - 0.2$	
V_{OH}	DC output logic high	$I_{OH} = -4mA$	$V_{DD} - 0.4$			
V_{OL}	DC output logic low	$I_{OL} = 4mA$			0.4	
V_{hys}	Hysteresis of Schmitt trigger input		0.1			
$I_{IH}^{(1)}$	Input high current				250	μA
$I_{IL1}^{(2)}$	Input low current		-250			
$I_{IL2}^{(3)}$	Input low current		-250			

Notes:

1. Includes input signals A1, A2, A4, Dx_[A:B], DE_[A:B], LB#, MODE#, PD#, Sx_[A:B], SCL, SDA, SEL_x[A:B]
2. For control inputs without pullups: SCL, SDA
3. Control inputs with pull-ups include: Dx_[A:B], DE_[A:B], LB#, MODE#, PD#, Sx_[A:B], SEL_x[A:B], A1, A2, A4

SDA and SCL I/O for I²C-bus ($V_{DD} = 1.2V \pm 5\%$, $T_A = -40$ TO $85^\circ C$)

Symbol	Parameter	Conditions	Min.	Typ.	Max.	Units
V_{IH}	DC input logic high		$0.85 \times V_{DD}$		3.6	V
V_{IL}	DC input logic low		-0.3		0.4	
V_{OL}	DC output logic low	$I_{OL} = 3mA$			0.4	
V_{hys}	Hysteresis of Schmitt trigger input		0.2			

Characteristics of the SDA and SCL bus lines for Standard Mode I²C-bus devices⁽¹⁾

Symbol	Parameter	Conditions	Min.	Typ.	Max.	Units
f _{SCL}	SCL clock frequency		0		100	kHz
t _{HD;STA}	Hold time (repeated) START condition. After this period, the first clock pulse is generated.		4.0		–	μs
t _{LOW}	LOW period of the SCL clock		4.7		–	
t _{HIGH}	HIGH period of the SCL clock		4.0		–	
t _{SU;STA}	Set-up time for a repeated START condition		4.7		–	
t _{HD;DAT}	Data hold time		10		–	ns
t _{SU;DAT}	Data set-up time		250		–	ns
t _r	Rise time of both SDA and SCL signals		-		1000	
t _f	Fall time of both SDA and SCL signals				300	
t _{SU;STO}	Set-up time for STOP condition		4.0		–	μs
t _{BUF}	Bus free time between a STOP and STOP condition		4.7		–	
C _b	Capacitive load for each bus line		-		400	pF

Notes:

1. All values referred to VIH min and VIL max levels

PI2EQX6814

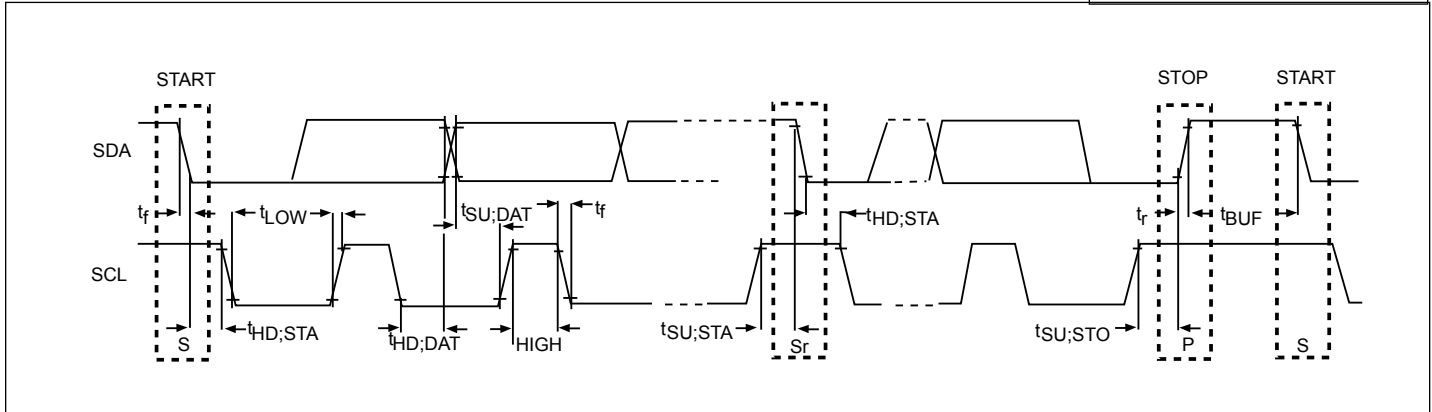

I²C Timing

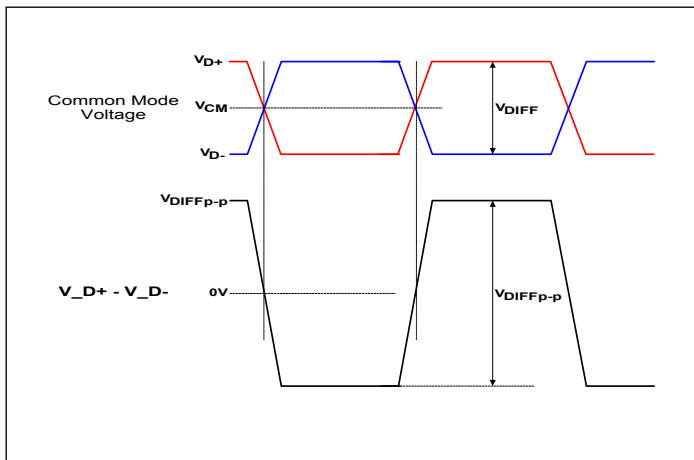

Definition of Differential Voltage and Differential Voltage Peak-to-Peak

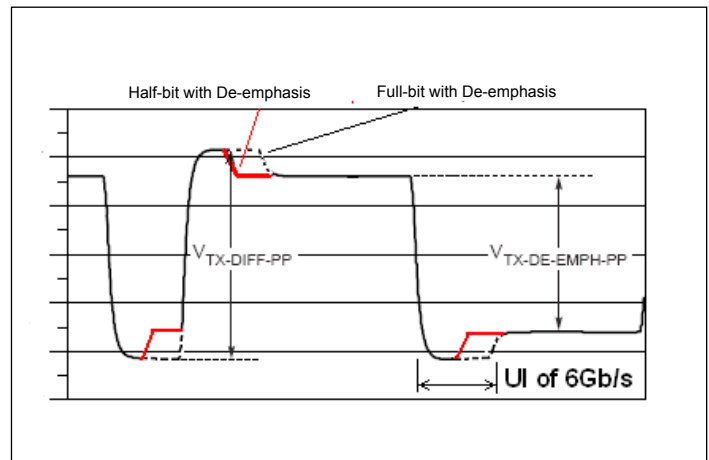

Definition of De-emphasis

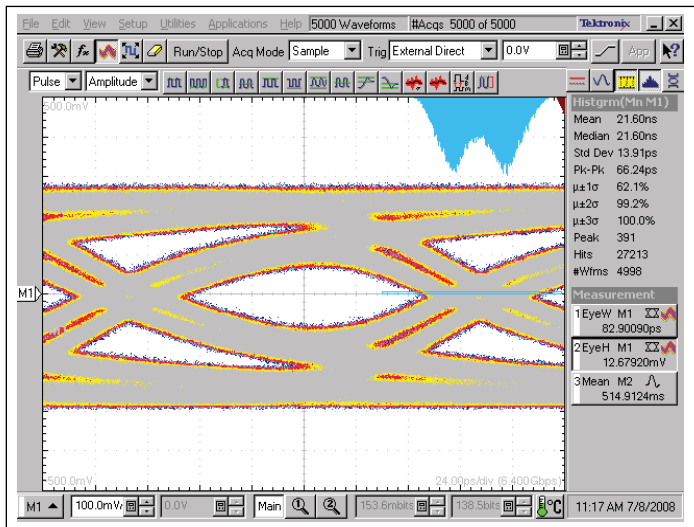

Input Eye

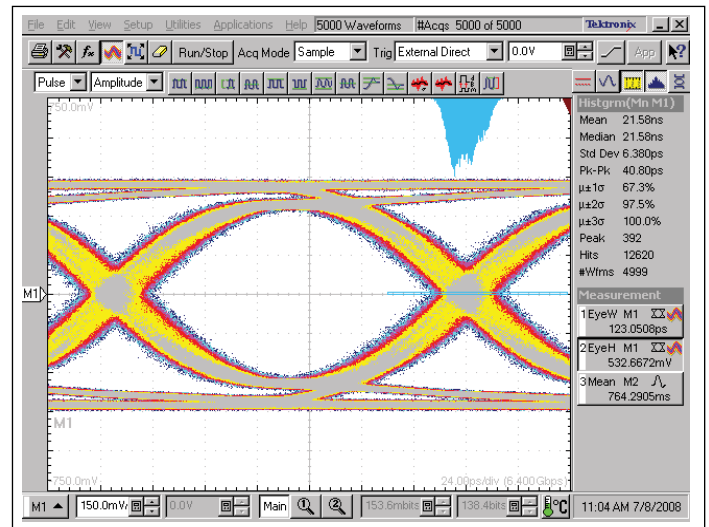

Output Eye

Signal Eyes @10dB input equalization, 24 inch FR4 input trace, 36 inch output cable

PI2EQX6814

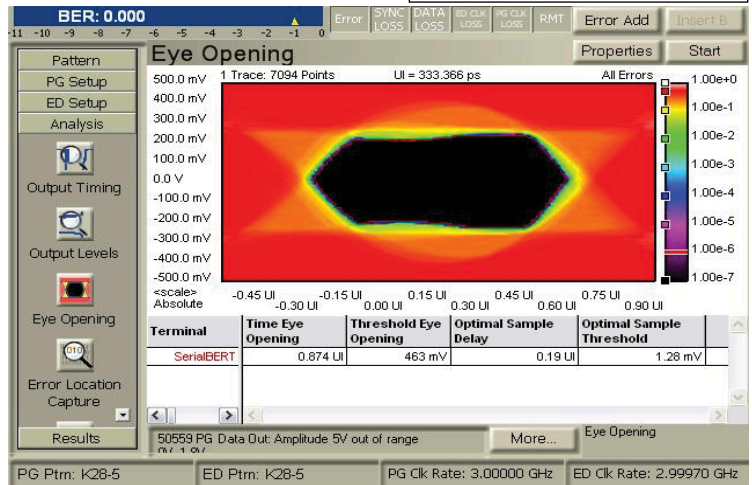
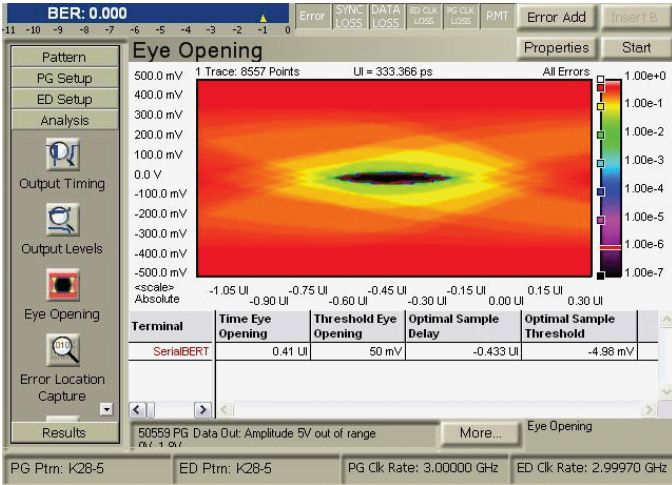

Signal Eyes at 13.8dB Input Equalization (EQ=111), 48" FR4 Input Trace and 36" Output Coax cable.

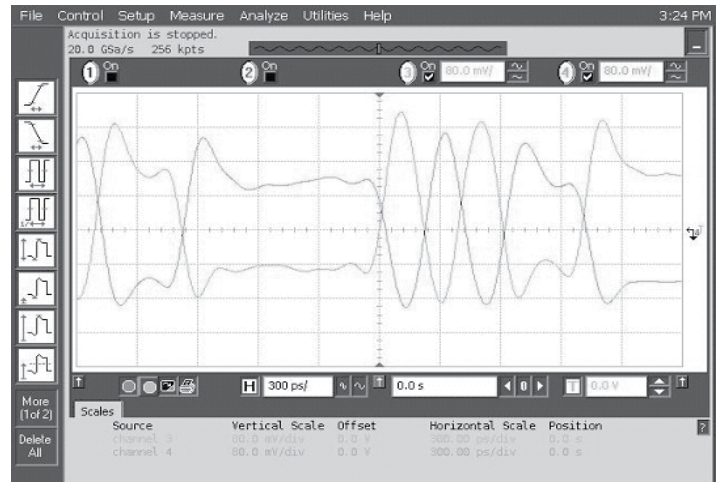

Data Waveforms, 3.0Gbps (left) & 6.0Gbps (right)

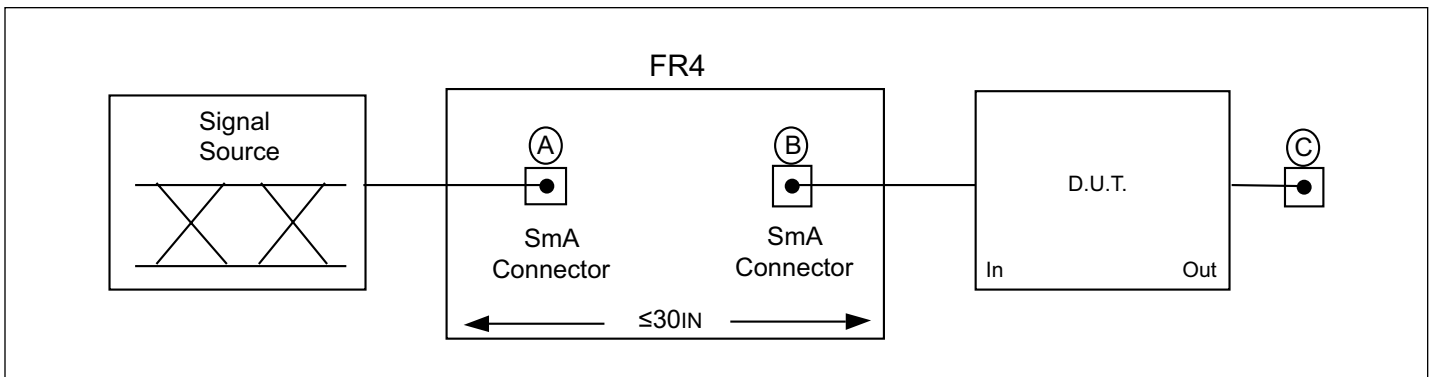

AC Test Circuit Referenced in the Electrical Characteristic Table

PI2EQX6814

Packaging Mechanical: 100-Contact LBGA (NJ)

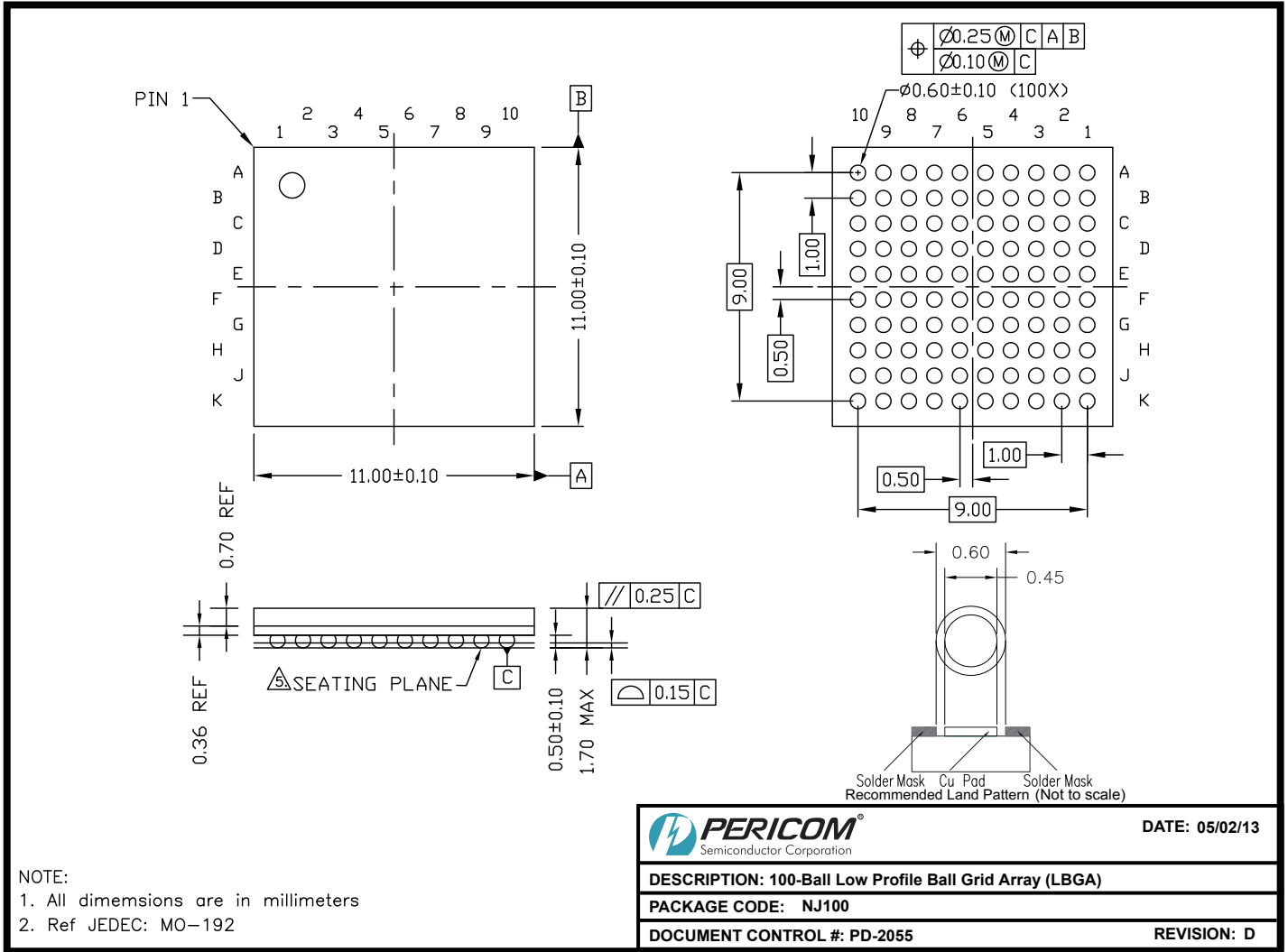

13-0083

Note: For latest package info, please check: <http://www.pericom.com/products/packaging/mechanicals.php>

Ordering Information

Ordering Number	Package Code	Package Description
PI2EQX6814NJE	NJ	100-Ball Low Profile Ball Grid Array (LBGA)
PI2EQX6814NJEX	NJ	100-Ball Low Profile Ball Grid Array (LBGA), Tape & Reel

Notes:

- Thermal characteristics can be found on the company web site at www.pericom.com/packaging/
- E = Pb-free and Green
- X suffix = Tape/Reel

Mouser Electronics

Authorized Distributor

Click to View Pricing, Inventory, Delivery & Lifecycle Information:

[Diodes Incorporated:](#)

[PI2EQX6814NJEX](#) [PI2EQX6814NJE](#)