

## Description

The AL8820 is a highly integrated high performance LED driver optimized for MR16/AR111 and other similar LED lamp applications. With a proprietary control scheme, the LED driver is compatible with many commonly used electronic transformers and meets High Power Factor (PF) and low Total Harmonic Distortion (THD) requirements for these applications.

The device integrates two DC/DC converters. The Two stage design offers superior performance for MR16/AR111 applications. The first stage is a boost PFC stage which improves PF, reduces EMI, powers up the Buck stage and the compatibility of Electronic Transformers. The Buck stage regulates the LED current thru the setting of external sense resistor. The integrated low  $R_{DS(ON)}$  of integrated MOSFETs reduce the conduction power loss. A compact thermally efficient SO-8EP package, the AL8820 provides an ideal solution for MR16/AR111 applications.

## Features

- Wide Input Voltage Range: 5V to 36V
- Internal 40V NDMOS Switch
- 2A Output Current
- Continuous Conduction Mode (CCM) Operation
- Up to 1MHz Switching Frequency
- High PF > 0.9 and Low THD < 30% and Low Ripple < 20%
- Internal Protections
  - Under Voltage Lock Out (UVLO)
  - Output Open/Short Protection
  - Over Temperature Protection (OTP)
- SO-8EP
- **Totally Lead-Free & Fully RoHS Compliant (Notes 1 & 2)**
- **Halogen and Antimony Free. "Green" Device (Note 3)**

Notes:

1. No purposely added lead. Fully EU Directive 2002/95/EC (RoHS), 2011/65/EU (RoHS 2) & 2015/863/EU (RoHS 3) compliant.
2. See <https://www.diodes.com/quality/lead-free/> for more information about Diodes Incorporated's definitions of Halogen- and Antimony-free, "Green" and Lead-free.
3. Halogen- and Antimony-free "Green" products are defined as those which contain <900ppm bromine, <900ppm chlorine (<1500ppm total Br + Cl) and <1000ppm antimony compounds.

## Pin Assignments

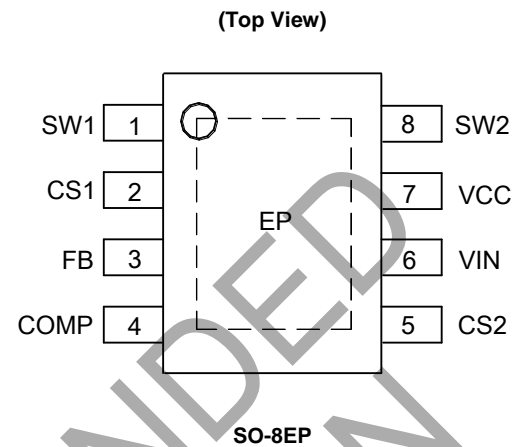

## Applications

- MR16 Lamps
- AR111
- General Illumination Lamps

## Typical Applications Circuit

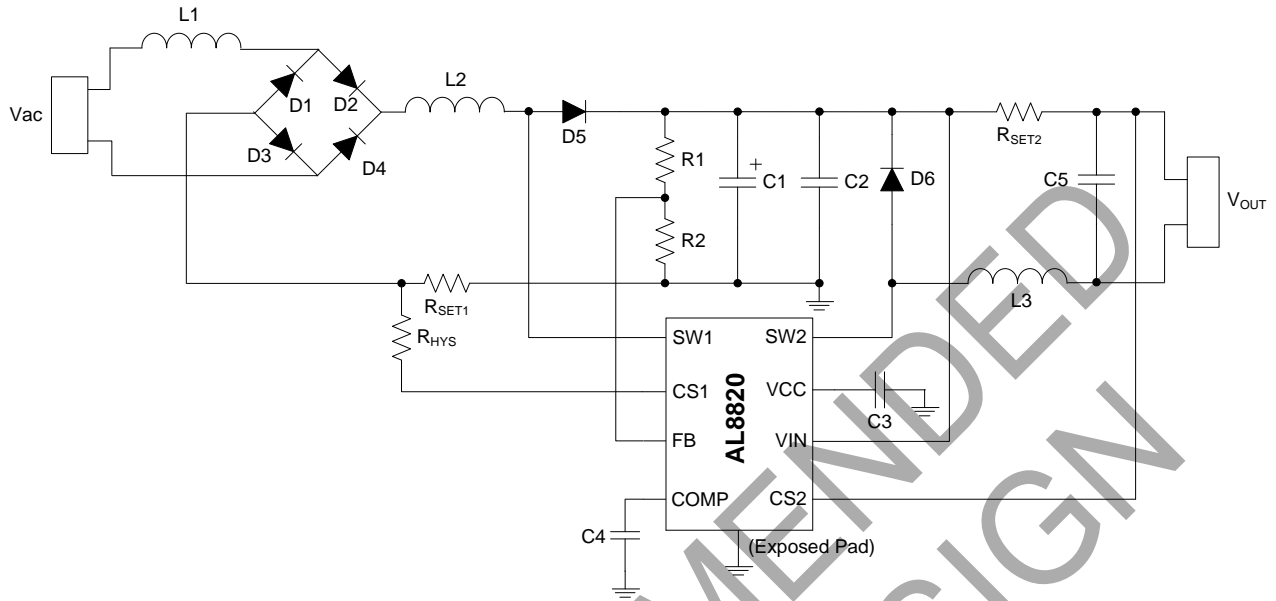

## Pin Descriptions

Pin Number	Pin Name	Function
1	SW1	Integrated Boost MOS Drain
2	CS1	Boost Input Current Sense Pin
3	FB	Boost Output Voltage Feedback Pin
4	COMP	Soft-start and Boost Control Loop Compensation
5	CS2	Buck Output Current Sense Pin
6	VIN	IC Input Voltage, Adding from Boost Output Voltage
7	VCC	Supply Voltage For Internal Circuit
8	SW2	Integrated Buck MOS Drain
9	Exposed Pad	Connected To Ground

## Functional Block Diagram

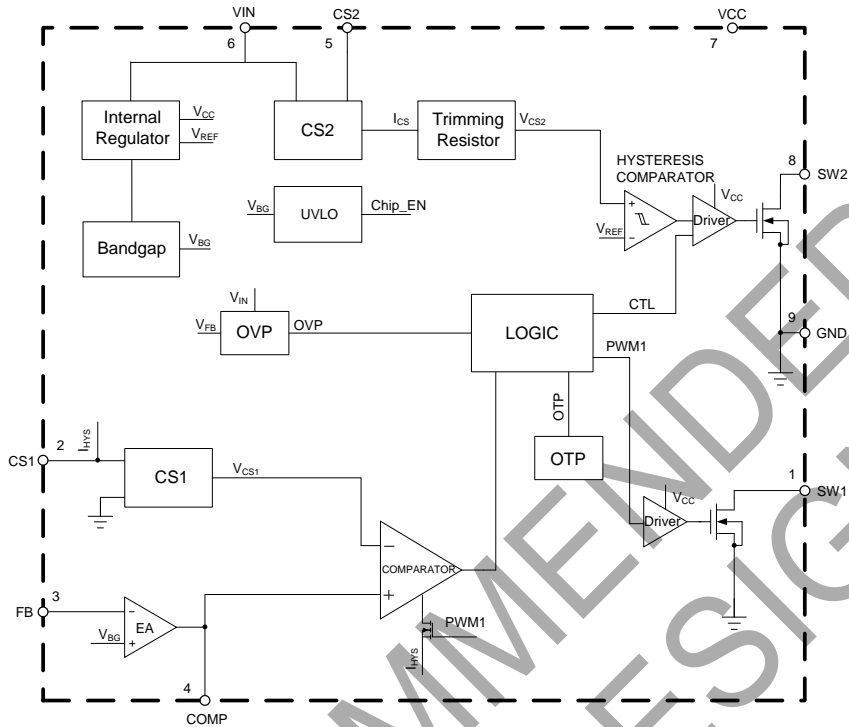

## Absolute Maximum Ratings (@T<sub>A</sub> = +25°C, unless otherwise specified. Note 4)

Parameter	Symbol	Value	Unit
VIN Pin Voltage	V <sub>IN</sub>	-0.3 to 40	V
SW1 Pin Voltage	V <sub>SW1</sub>	-0.3 to 40	V
SW2 Pin Voltage	V <sub>SW2</sub>	-0.3 to 40	V
COMP Pin Voltage	V <sub>COMP</sub>	-0.3 to 6	V
CS1 Pin Voltage	V <sub>CS1</sub>	-0.3 to 6	V
CS2 Pin Voltage	V <sub>CS2</sub>	-0.3 to 40	V
FB Pin Voltage	V <sub>FB</sub>	-0.3 to 6	V
VCC Pin Voltage	V <sub>CC</sub>	-0.3 to 6	V
Operating Junction Temperature	T <sub>J</sub>	+150	°C
Storage Temperature	T <sub>STG</sub>	-65 to +150	°C
Thermal Resistance (Junction To Ambient) (Note 5)	θ <sub>JA</sub>	66	°C/W
Lead Temperature (Soldering, 10sec)	T <sub>LEAD</sub>	+300	°C
ESD (Machine Model)	—	200	V
ESD (Human Body Model)	—	2000	V

- Notes:
- Stresses greater than those listed under "Absolute Maximum Ratings" may cause permanent damage to the device. These are stress ratings only and functional operation of the device at these or any other conditions beyond those indicated under "Recommended Operating Conditions" is not implied. Exposure to "Absolute Maximum Ratings" for extended periods may affect device reliability.
  - Device mounted on FR-4 PCB (51mm x 51mm) 2oz copper, minimum recommended pad layout on top layer and thermal vias to bottom layer ground plane. For better thermal performance, larger copper pad for heat-sink is needed.

## Recommended Operating Conditions

Symbol	Parameter	Min	Max	Unit
V <sub>IN</sub>	VIN Pin Voltage	5	36	V
T <sub>A</sub>	Ambient Temperature	-40	+105	°C

## Electrical Characteristics (@T<sub>A</sub> = +25°C, unless otherwise specified.)

Parameters	Symbol	Conditions	Min	Typ	Max	Unit
<b>Input Supply</b>						
VIN Pin Voltage	V <sub>IN</sub>	—	5	—	36	V
Quiescent Current	I <sub>Q</sub>	No switching	—	1	—	mA
Under-Voltage Lockout Voltage	V <sub>UVLO</sub>	V <sub>IN</sub> Rising	—	4.2	—	V
UVLO Hysteresis	V <sub>HYS</sub>	—	—	500	—	mV
<b>VCC Regulator</b>						
VCC Pin Voltage	V <sub>CC</sub>	—	4.5	5	5.5	V
Source Current Capability	—	V <sub>CC</sub> = 5V	10	—	—	mA
Load Regulation	—	—	—	4	—	%
<b>Integrated NMOS_BUCK</b>						
MOS Voltage Stress (Note 6)	V <sub>DS1</sub>	—	—	40	—	V
MOS Current Stress (Note 6)	I <sub>DS1</sub>	—	—	2	—	A
MOS R <sub>DS(on)</sub>	R <sub>DS(on)1</sub>	—	—	250	—	mΩ
<b>Integrated NMOS_BOOST</b>						
MOS Voltage Stress (Note 6)	V <sub>DS2</sub>	—	—	40	—	V
MOS Current Stress (Note 6)	I <sub>DS2</sub>	—	—	2	—	A
MOS R <sub>DS(on)</sub>	R <sub>DS(on)2</sub>	—	—	250	—	mΩ
<b>Compensation and Soft Start (COMP Pin)</b>						
Error Amplifier Trans-conductance	GEA	—	—	1000	—	μA/V
Sourcing Current	I <sub>O_H</sub>	V <sub>COMP</sub> = 0.5V	—	68	—	μA
Sinking Current	I <sub>O_L</sub>	V <sub>COMP</sub> = 4.5V	—	68	—	μA
FB Pin Voltage	V <sub>FB</sub>	—	1.18	1.22	1.26	V
FB OVP Voltage	V <sub>OVP</sub>	—	1.59	1.66	1.75	V
FB OVP Voltage Hysteresis	V <sub>OVP_HYS</sub>	—	0.15	0.2	0.25	V

**Electrical Characteristics** (Cont. @T<sub>A</sub> = +25°C, unless otherwise specified.)

Parameters	Symbol	Conditions	Min	Typ	Max	Unit
<b>Hysteresis Competitor (Boost)</b>						
Boost Sense Voltage Low Level	V <sub>CS1_MIN</sub>	V <sub>COMP</sub> = 0V	—	-90	—	mV
Hysteresis Current	I <sub>HYS</sub>	—	85	100	115	μA
<b>Hysteresis Competitor (Buck)</b>						
Buck Sense Voltage High Level	V <sub>CSH</sub>	—	—	115	—	mV
Buck Sense Voltage Low Level	V <sub>CSL</sub>	—	—	85	—	mV
Buck Sense Voltage Average Level	V <sub>CS2_AVE</sub>	—	95	100	105	mV
<b>Over-Temperature Protection</b>						
Thermal Shutdown (Note 6)	T <sub>OTSD</sub>	—	+140	+160	—	°C
Thermal Shutdown Hysteresis (Note 6)	T <sub>HYS</sub>	—	—	+40	—	°C

Note 6: These parameters, although guaranteed by design, are not 100% tested in production.

NOT RECOMMENDED FOR NEW DESIGN

**Performance Characteristics**

**Quiescent Current vs. VIN Pin Voltage**

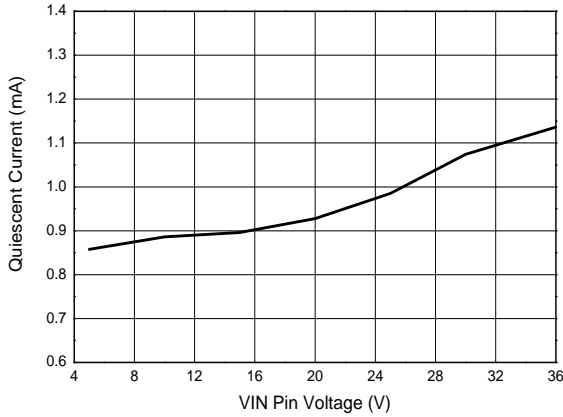

**Quiescent Current vs. Ambient Temperature**

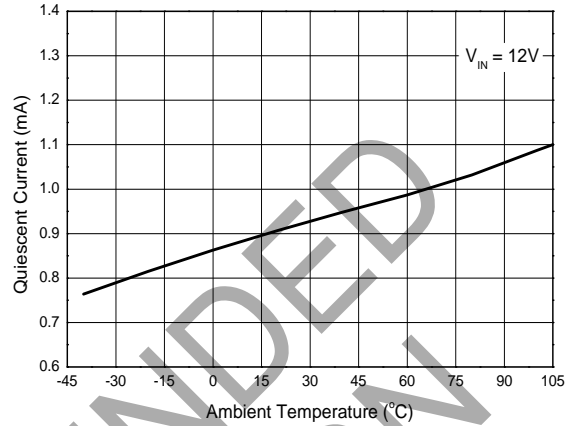

**VCC Pin Voltage vs. VIN Pin Voltage**

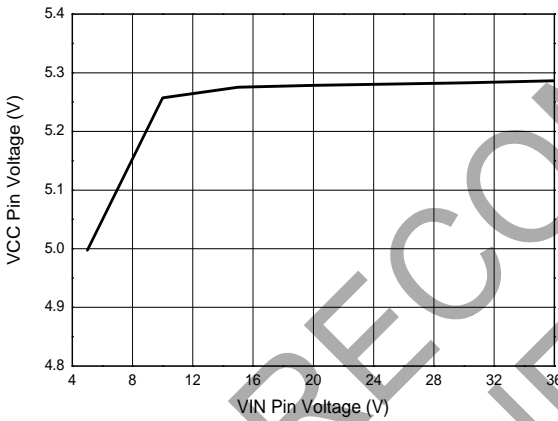

**VCC Pin Voltage vs. Ambient Temperature**

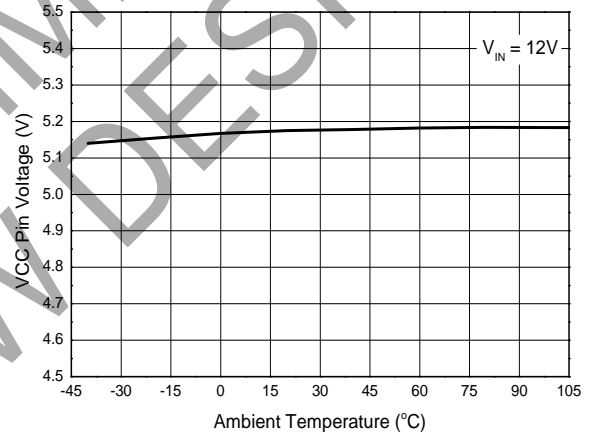

**FB Pin Voltage vs. VIN Pin Voltage**

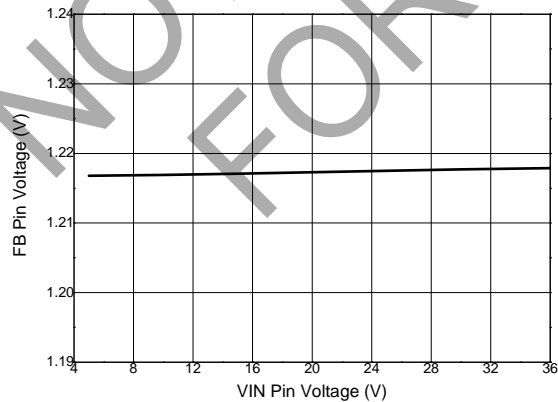

**FB Pin Voltage vs. Ambient Temperature**

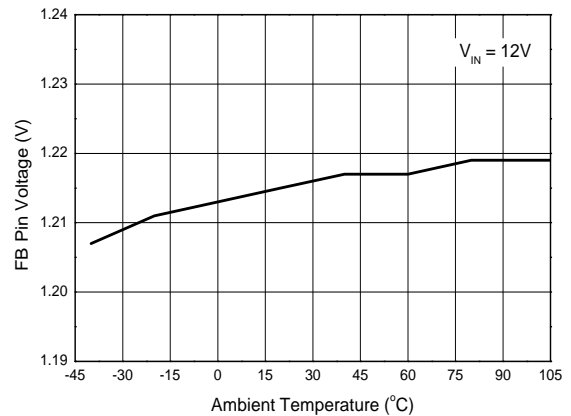

**Performance Characteristics (Cont.)**

**Boost Sense Voltage Low Level vs. VIN Pin Voltage**

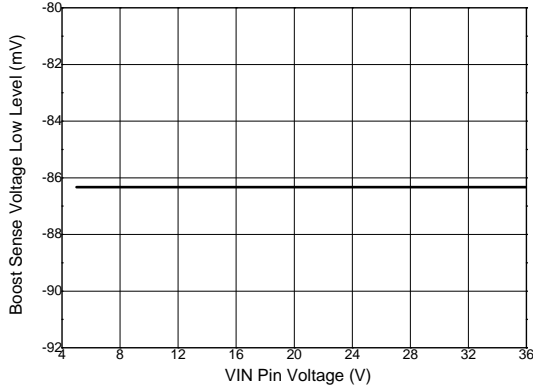

**Boost Sense Voltage Low Level vs. Ambient Temperature**

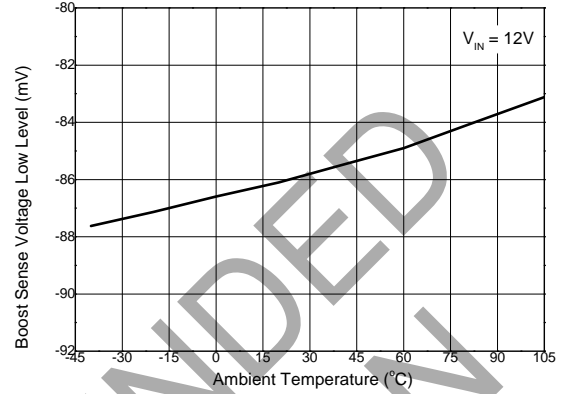

**Hysteresis Current vs. VIN Pin Voltage**

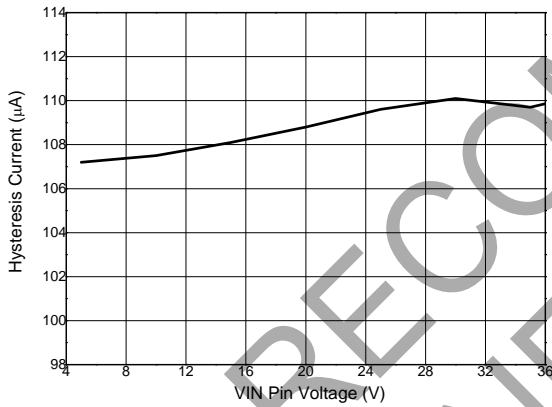

**Hysteresis Current vs. Ambient Temperature**

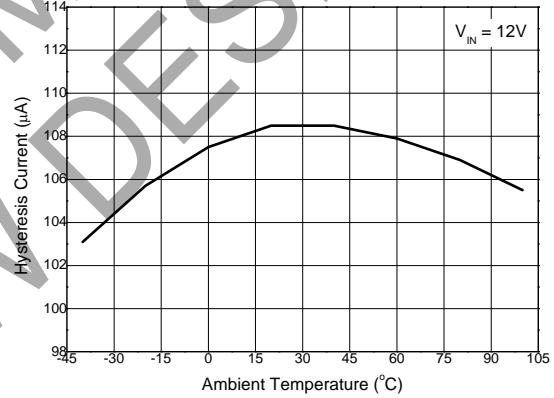

**Buck Sense Voltage Average Level vs. VIN Pin Voltage**

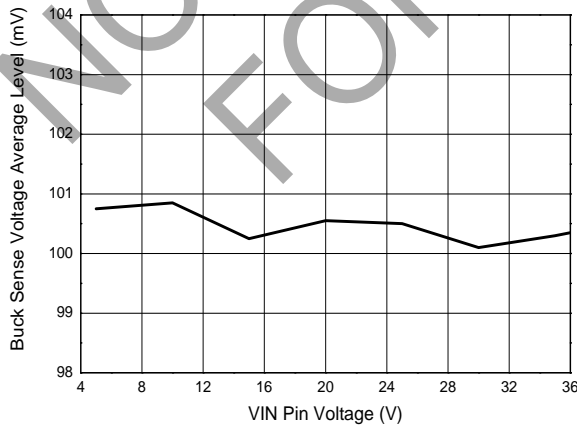

**Buck Sense Voltage Average Level vs. Ambient Temperature**

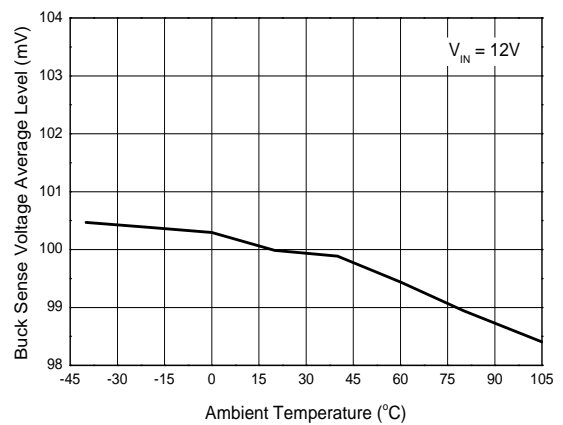

**Application Information**

**AL8820 Operation**

The device integrates two DC/DC regulators. This two stage design offers superior performance for MR16/AR111 applications. The first stage is a boost PFC stage which improves PF, reduces EMI and conditions the input to be compatible with many of the most commonly used Electronic Transformers (ET). This input stage also provides power for the second stage buck converter which provides regulated constant output current for the LEDs.

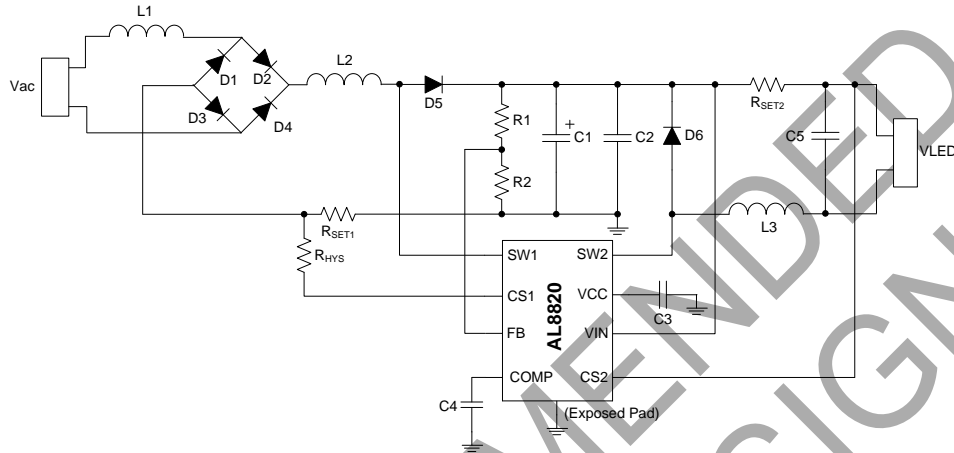

Figure 1. Typical Application Circuit

**V<sub>IN</sub> Voltage Setting**

V<sub>IN</sub> Voltage is the output voltage of boost section and is also the input voltage of the buck section. Therefore V<sub>IN</sub> must be set sufficiently higher than the output voltage of buck section. For the Boost application, the output voltage can be defined as:

$$V_{IN} = 1.22V \times \frac{R1 + R2}{R2}$$

**R<sub>SET1</sub> and R<sub>HYS</sub> Setting**

The Boost converter of the AL8820 operates at continuous conduction mode and is based on hysteresis schematic which has lower threshold and upper threshold. Refer to Figure 2 depicting the inductor current waveform.

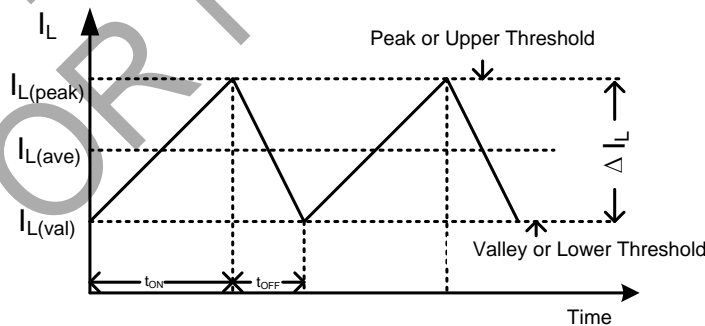

Figure 2. Inductor Current

When switch SW1 is turned on, the inductor current flows through R<sub>SET1</sub> and ramps up linearly. The rising current produces a voltage ramp across R<sub>SET1</sub>. When the voltage across R<sub>SET1</sub> reaches the upper threshold, switch SW1 is turned off. The inductor current continues to flow through R<sub>SET1</sub> but decays. The decaying current produces a falling voltage at R<sub>SET1</sub>. When the voltage across R<sub>SET1</sub> falls to the lower threshold, switch SW1 is turned on again.

The lower threshold voltage V<sub>LT</sub> depends on the voltage V<sub>COMP</sub> at COMP pin that varies with the input voltage and output load. The equation is shown as below.



## Application Information (Cont.)

$$V_{LT} = \begin{cases} \frac{(V_{COMP} - 1.5) \times 0.6 + 1.4}{16} mV, & 1.5V \leq V_{COMP} \leq 5V \\ 88mV, & 0V \leq V_{COMP} \leq 1.5V \end{cases}$$

The range of  $V_{COMP}$  is from 0V to 5V.

The upper threshold depends on the lower threshold and the hysteresis value. The hysteresis value is set by external resistor  $R_{HYS}$ . It is defined as below.

$$V_{HYS} = R_{HYS} \times 100\mu A$$

According to the operation principle, the peak to peak current  $\Delta I_L$  and the valley current  $I_{L(val)}$  can be obtained by the below equations.

$$I_{L(val)} = \frac{V_{LT}}{R_{SET1}}$$

$$\Delta I_L = \frac{V_{HYS}}{R_{SET1}}$$

Where:

$\Delta I_L$  is the peak to peak current of inductor.

$I_{L(val)}$  is the valley current of inductor.

From the Figure 2, the relationship between  $I_{L(peak)}$ ,  $I_{L(val)}$ ,  $I_{L(ave)}$  and  $\Delta I_L$  can be obtained as below.

$$I_{L(peak)} = I_{L(val)} + \Delta I_L$$

$$I_{L(ave)} = I_{L(val)} + \frac{1}{2} \times \Delta I_L$$

Where:

$I_{L(peak)}$  is the peak current of inductor.

$I_{L(ave)}$  is the average current of inductor.

As we know the average current  $I_{L(ave)}$  depends on the output power, rated input voltage  $V_{IN1}$  of boost converter and total efficiency  $\eta$ . So the average current  $I_{L(ave)}$  can be obtained by the below equation.

$$I_{L(ave)} = \frac{V_{LED} \times I_{LED}}{\eta \times V_{IN1}}$$

Where:

## Application Information (Cont.)

$V_{LED}$  is the output voltage of Buck converter.

$I_{LED}$  is the output current of Buck converter.

Set ratio of  $\Delta I_L$  to  $I_{L(peak)}$  as K.

$$K = \frac{\Delta I_L}{I_{L(peak)}}$$

$R_{SET1}$  and  $R_{HYS}$  can be obtained from above equations:

$$R_{SET1} = \begin{cases} \frac{((V_{COMP} - 1.5) \times 0.6 + 1.4) \times (2 - K) \times \eta \times V_{IN1} \times 10^{-3}}{32 \times V_{LED} \times I_{LED} \times (1 - K)} & 1.5V \leq V_{COMP} \leq 5V \\ \frac{44 \times (2 - K) \times \eta \times V_{IN1} \times 10^{-3}}{V_{LED} \times I_{LED} \times (1 - K)} & 0V \leq V_{COMP} \leq 1.5V \end{cases}$$

$$R_{HYS} = \frac{2 \times V_{LED} \times I_{LED} \times K \times R_{SET1} \times 10^4}{\eta \times V_{IN1} \times (2 - K)}$$

When the value of K,  $\eta$  and  $V_{COMP}$  are provided, the value of resistor  $R_{SET1}$  and  $R_{HYS}$  can be calculated according to these above equations. In order to get appropriate efficiency and Electronic Transformer (ET) compatibility, generally K is set between 0.4 and 0.8. Due to the range of  $V_{COMP}$  is from 0V to 5V, in order to get output voltage regulation, generally  $V_{COMP}$  is set as 3V at rated input voltage.

### Step-Up Converter Inductor Selection

Because of the using of the hysteretic control scheme, the switching frequency in a boost configuration can be adjusted in accordance to the value of the inductor being used. The value of the inductor can be determined by using the following equation:

$$L_2 = \frac{[V_{IN1} - (R_{SET1} + R_L + R_{DSO1}) \times I_{L(ave)}] \times [V_{IN} - V_{IN1} - V_F - (R_L + R_{SET1}) \times I_{L(ave)}]}{\Delta I_L [V_{IN} - V_F - (2R_{SET1} + 2R_L - R_{DSO1}) \times I_{L(ave)}] \times f_{SW1}}$$

Where:

$L_2$  is the coil inductance.

$R_L$  is the coil resistance.

$R_{SET1}$  is the current sense resistance.

$R_{DSO1}$  is the switch SW1 resistance.

$V_{IN1}$  is the rated input voltage of the boost converter.

$V_{IN}$  is the output voltage of boost converter.

$V_F$  is the diode forward voltage at the required load current.

$f_{SW1}$  is the desired switching frequency.

## Application Information (Cont.)

Low switching frequency can decrease the switching loss but need to choose higher inductor values that will result in larger size in order to meet the saturation current. For example, the relationship between switching frequency and inductor value is shown as below Table 1 in the same application system. Considering these factors, 500kHz switching frequency is recommended in typical application.

Inductance Value of L2 @ Vac = 12Vac, VIN = 22V, VOUT = 10V, IOUT = 650mA	Operation Frequency of SW1 at Peak Voltage of Vac
10μH	637kHz
15μH	500kHz
27μH	373kHz

Table 1

### LED Current Control

The LED current is controlled by the resistor RSET2 in Figure 1.

Connected between VIN pin and CS2 pin, the nominal average output current in the LED(s) is defined as:

$$I_{LED} = \frac{100mV}{R_{SET2}}$$

### Buck Converter Inductor Selection

The inductance L3 in Buck converter is determined by the following factors: inductor ripple current, switching frequency, VLED/VIN ratio, internal FET, and component parameter. The inductance L3 is calculated according to the following equation:

$$L3 \geq \frac{V_{IN} - V_{LED} - (R_{SET2} + R_{DSON2} + R_{COIL}) \times I_{LED}}{\Delta I_{LED}} \times \frac{V_{LED}}{V_{IN}} \times \frac{1}{f_{SW2}}$$

Where:

VIN is the output voltage of Boost converter.

VLED is the output voltage of Buck converter.

RSET2 is the current sense resistance.

RDSO2 is the switch resistance (=0.25Ω).

RCOIL is the coil resistance of inductor L3.

ΔILED is the coil peak-peak ripple current, internally set to 0.25 x ILED.

fSW2 is the switching frequency.

The low switching frequency fSW2 is recommended in order to minimize errors due to switching delays which will result in increased ripple and lower efficiency. Higher switching frequency can choose smaller inductor value that has smaller size in order to meet the saturation current but will increase the switching loss. For example, the relationship between switching frequency and inductor value is shown as below Table 2 in the same application system. Considering these factors, about 300kHz switching frequency is recommended in typical application.

## Application Information (Cont.)

Inductance Value of L3 @ $V_{IN} = 22V_{ac}$ , $V_{OUT} = 10V$ , $I_{OUT} = 650mA$	Operation Frequency of SW2
33 $\mu$ H	756kHz
47 $\mu$ H	568kHz
68 $\mu$ H	397kHz
100 $\mu$ H	257kHz

Table 2

### VIN OVP Protection

The AL8820 has two kinds of Over-voltage (OVP) protection both of which turn off the power switch SW1. When the voltage at the FB pin exceeds threshold approximately 1.66V, the power switch of step-up stage is turned off. The power switch of boost section can be turned on again once the voltage at the FB pin drops below 1.46V.

The AL8820 additionally has an internal over voltage protection to protect the AL8820 from excessive input voltage. When the voltage applied at VIN pin exceeds 39V, it will turn off the power switch SW1. The power switch will turn on once the voltage at VIN drops below 34V.

### VCC Regulator

The VCC pin requires a capacitor for stable operation and to store the charge for the large GATE switching currents. Choose a 10V rated low ESR, X7R or X5R, ceramic capacitor for best performance. A 4.7 $\mu$ F capacitor will be adequate for many applications. Place the capacitor close to the IC to minimize the trace length between the VCC pin and the exposed pad.

An internal current limit on the VCC output protects against excessive on-chip power dissipation. The VCC pin has set the output to 5V (typ.) to protect the internal FETs from excessive power dissipation caused by not being fully enhanced. If the VCC pin is used to drive extra circuits beside the AL8820, the extra loads should be limited to less than 8mA.

### Output Capacitor C1 and C2 of Boost

The capacitor C1 is used to hold the bus voltage when the electronic transformer has no output. For most applications, it is recommended to use an aluminum electrolytic capacitor with greater than 220 $\mu$ F capacitance.

The output capacitor C2 is selected to handle the output ripple noise requirements. For the best performance, it is recommended to use X7R or better grade ceramic capacitor greater than 1 $\mu$ F capacitance.

### Compensation Capacitor C4

In applications powered by electronic transformer, the input voltage can change roughly in one cycle of AC power frequency. A 1 $\mu$ F ceramic capacitor C4 connected from COMP pin to ground help to stabilize the control loop of the Boost regulator.

### Output Capacitor C5 of Buck

Higher LED current ripple will shorten the LED life time and increase heat accumulation of LED. To reduce the LED current ripple, an output capacitor in parallel with the LED should be added. Lower ripple can be achieved with higher capacitor values. For most applications, a value of 4.7 $\mu$ F is recommended.

### Diode Selection

For maximum efficiency and performance, the rectifiers (D5, D6) should be fast low capacitance Schottky diodes with low reverse leakage at maximum operating voltage and temperature. With its low power dissipation, the Schottky diode outperforms other silicon diodes and increases overall efficiency.

### Over Temperature Protection

A over temperature protection feature is to protect the AL8820 from excessive internal temperature. When the junction temperature exceeds +160°C, the internal FETs will be turned off. When junction temperature drops below +120°C, IC will turn on both FETs and return to normal operation.

**Ordering Information**

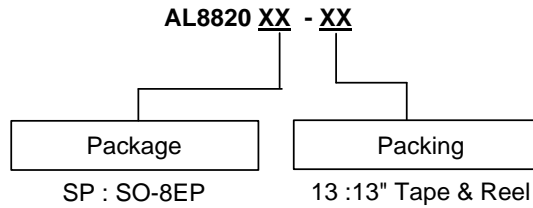

Part Number	Package Code	Package	13" Tape and Reel	
			Quantity	Part Number Suffix
AL8820SP-13	SP	SO-8EP	2500/Tape & Reel	-13

**Marking Information**

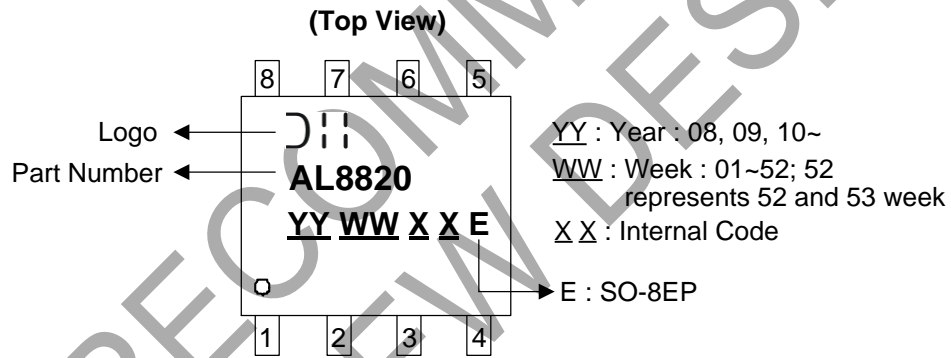

**Package Outline Dimensions** (All dimensions in mm(inch).)

(1) Package Type: SO-8EP

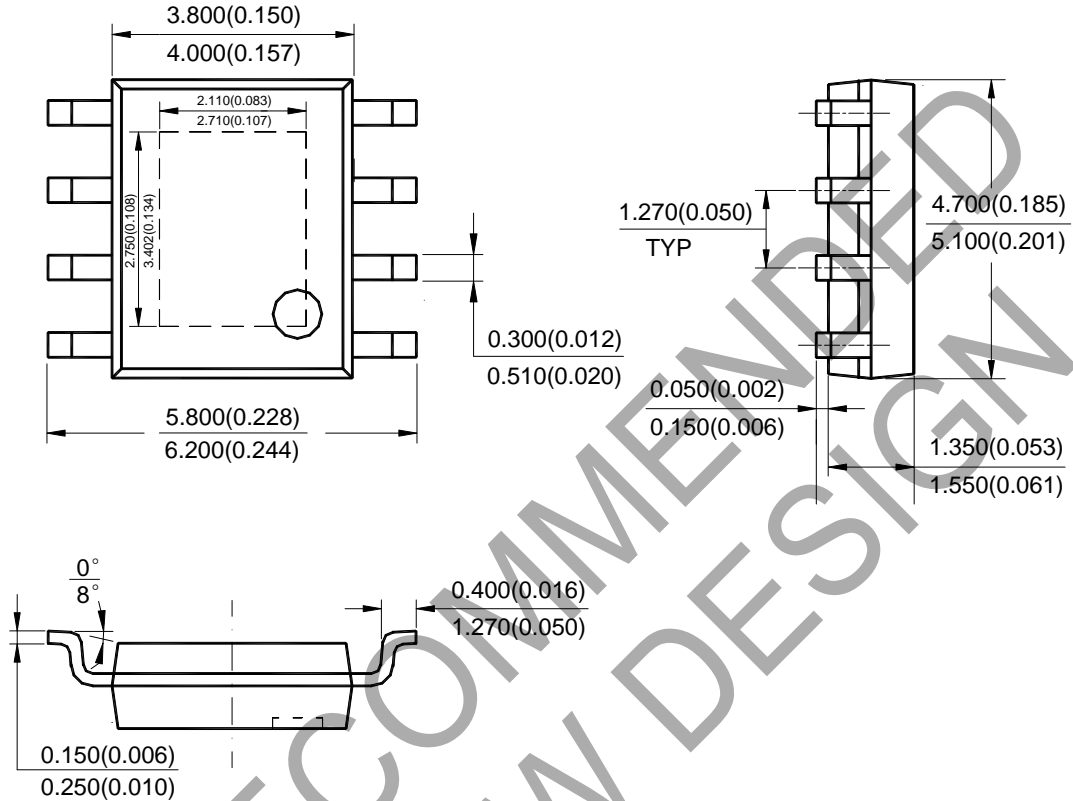

Note: Eject hole, oriented hole and mold mark is optional.

NOT RECOMMENDED FOR NEW DESIGN

**Suggested Pad Layout**

(1) Package Type: SO-8EP

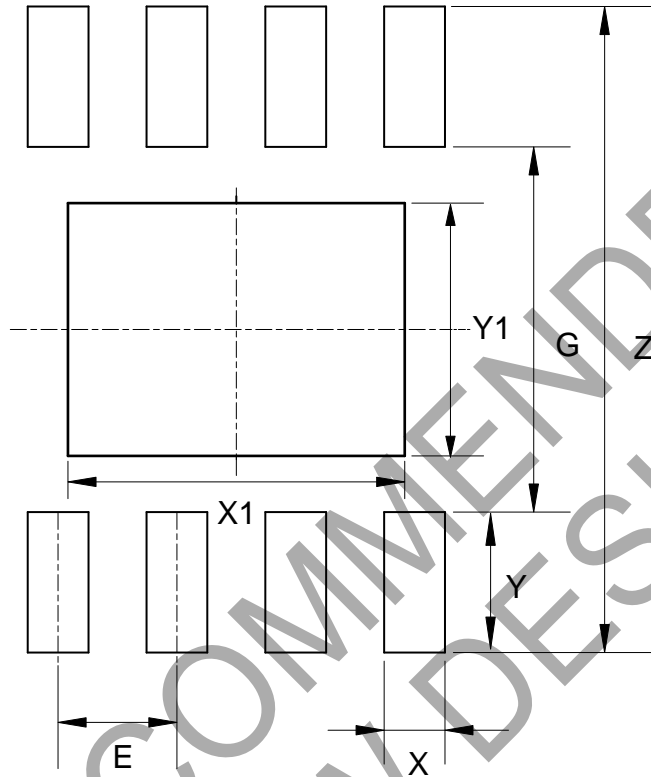

Dimensions	Z (mm)/(inch)	G (mm)/(inch)	X (mm)/(inch)	Y (mm)/(inch)	X1 (mm)/(inch)	Y1 (mm)/(inch)	E (mm)/(inch)
Value	6.900/0.272	3.900/0.154	0.650/0.026	1.500/0.059	3.600/0.142	2.700/0.106	1.270/0.050

**IMPORTANT NOTICE**

DIODES INCORPORATED MAKES NO WARRANTY OF ANY KIND, EXPRESS OR IMPLIED, WITH REGARDS TO THIS DOCUMENT, INCLUDING, BUT NOT LIMITED TO, THE IMPLIED WARRANTIES OF MERCHANTABILITY AND FITNESS FOR A PARTICULAR PURPOSE (AND THEIR EQUIVALENTS UNDER THE LAWS OF ANY JURISDICTION).

Diodes Incorporated and its subsidiaries reserve the right to make modifications, enhancements, improvements, corrections or other changes without further notice to this document and any product described herein. Diodes Incorporated does not assume any liability arising out of the application or use of this document or any product described herein; neither does Diodes Incorporated convey any license under its patent or trademark rights, nor the rights of others. Any Customer or user of this document or products described herein in such applications shall assume all risks of such use and will agree to hold Diodes Incorporated and all the companies whose products are represented on Diodes Incorporated website, harmless against all damages.

Diodes Incorporated does not warrant or accept any liability whatsoever in respect of any products purchased through unauthorized sales channel. Should Customers purchase or use Diodes Incorporated products for any unintended or unauthorized application, Customers shall indemnify and hold Diodes Incorporated and its representatives harmless against all claims, damages, expenses, and attorney fees arising out of, directly or indirectly, any claim of personal injury or death associated with such unintended or unauthorized application.

Products described herein may be covered by one or more United States, international or foreign patents pending. Product names and markings noted herein may also be covered by one or more United States, international or foreign trademarks.

This document is written in English but may be translated into multiple languages for reference. Only the English version of this document is the final and determinative format released by Diodes Incorporated.

**LIFE SUPPORT**

Diodes Incorporated products are specifically not authorized for use as critical components in life support devices or systems without the express written approval of the Chief Executive Officer of Diodes Incorporated. As used herein:

A. Life support devices or systems are devices or systems which:

1. are intended to implant into the body, or
2. support or sustain life and whose failure to perform when properly used in accordance with instructions for use provided in the labeling can be reasonably expected to result in significant injury to the user.

B. A critical component is any component in a life support device or system whose failure to perform can be reasonably expected to cause the failure of the life support device or to affect its safety or effectiveness.

Customers represent that they have all necessary expertise in the safety and regulatory ramifications of their life support devices or systems, and acknowledge and agree that they are solely responsible for all legal, regulatory and safety-related requirements concerning their products and any use of Diodes Incorporated products in such safety-critical, life support devices or systems, notwithstanding any devices- or systems-related information or support that may be provided by Diodes Incorporated. Further, Customers must fully indemnify Diodes Incorporated and its representatives against any damages arising out of the use of Diodes Incorporated products in such safety-critical, life support devices or systems.

Copyright © 2018, Diodes Incorporated

[www.diodes.com](http://www.diodes.com)



# Mouser Electronics

Authorized Distributor

Click to View Pricing, Inventory, Delivery & Lifecycle Information:

[Diodes Incorporated:](#)

[AL8820SP-13](#)