

Product Summary (@T_A = +25°C)

PPK	IFSM (A)	VRWM (V)	PM(AV)
3600W	500	10 to 43	5W

Description and Applications

Suitable to protect sensitive automotive circuits against surges defined in ISO7637-2 and against load dump surge according to ISO16750-2.

Compliance with the following standards:

- ISO 16750-2, Pulse A and Pulse B
- ISO 7637-2 (Note 5)
Pulse 1, Pulse 2a, Pulse 3a, Pulse 3b

Features and Benefits

- 3600W Peak Pulse Power Dissipation
- High Current Capability
- Low Reverse Current
- Low Thermal Resistance
- Low Power Loss and High Efficiency
- Excellent High Temperature Stability
- Meets ISO7637-2 Surge Capability
- Meets ISO16750-2 Surge Specification
- **Lead-Free Finish; RoHS Compliant (Notes 1 & 2)**
- **Halogen and Antimony Free. "Green" Device (Note 3)**
- **The DM5W10AQ-DM5W43AQ are suitable for automotive applications requiring specific change control; these parts are AEC-Q101 qualified, PPAP capable, and manufactured in IATF 16949 certified facilities.**

<https://www.diodes.com/quality/product-definitions/>

Mechanical Data

- Package: DO-218
- Package Material: Molded Plastic.
UL Flammability Classification Rating 94V-0
- Moisture Sensitivity: Level 1 per J-STD-020
- Terminals: Lead-Free Plating (Matte Tin Finish). Solderable per MIL-STD-202, Method 208 (63)
- Polarity Indicator: Heatsink Is Anode
- Weight: 2.74 grams (Approximate)

DO-218 (Type E)



Top View

Polarity: Heatsink is anode

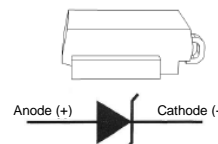

Pin Information

Ordering Information (Note 4)

Part Number	Qualification	Package	Packing	
			Qty.	Carrier
DM5WxxAQ-13	Automotive	DO-218 (Type E)	750	Tape & Reel

*x = Device Voltage, e.g., DM5W10AQ-13

- Notes:
1. EU Directive 2002/95/EC (RoHS), 2011/65/EU (RoHS 2) & 2015/863/EU (RoHS 3) compliant. All applicable RoHS exemptions applied.
 2. See <https://www.diodes.com/quality/lead-free/> for more information about Diodes Incorporated's definitions of Halogen- and Antimony-free, "Green" and Lead-free.
 3. Halogen- and Antimony-free "Green" products are defined as those which contain <900ppm bromine, <900ppm chlorine (<1500ppm total Br + Cl) and <1000ppm antimony compounds.
 4. For packaging details, go to our website at <https://www.diodes.com/design/support/packaging/diodes-packaging/>.
 5. Not applicable to parts with stand-off voltage lower than the average battery voltage (13.5V).

Marking Information



M5WxxA = Product Type Marking Code (i.e. M5W10A for DM5W10AQ-13)
 J|| = Manufacturers' Code Marking
 aa: Wafer source code
 y: Year (M = 2022)
 m: Month (1 – C)
 d: Date (1 – V)
 cc: Lot serial number
 Bar Denotes Cathode Pin, Circle Denotes Anode

Date Code Key

Year	2018	...	2022	2023	2024	2025	2026	2027	2028	2029	2030	2031
Code	I	...	M	N	O	P	Q	R	S	T	U	V

Month	Jan	Feb	Mar	Apr	May	Jun	Jul	Aug	Sep	Oct	Nov	Dec
Code	1	2	3	4	5	6	7	8	9	A	B	C

Date	1	2	3	...	9	10	11	12	...	29	30	31
Code	1	2	3	...	9	A	B	C	...	T	U	V

Maximum Ratings (@T_A = +25°C, unless otherwise specified.)

Characteristic	Symbol	Value	Unit
Peak Pulse Power Dissipation (Non Repetitive Current Pulse Derated above T _A = +25°C) (Note 6)	P _{PK}	10/1000µs Waveform	3600
		10/10000µs Waveform	2800
Peak Forward Surge Current, 8.3ms Single Half Sine-Wave Superimposed on Rated Load (Note 7)	I _{FSM}	500	A
Steady State Power Dissipation @T _C = +25°C	PM _(AV)	5.0	W

Thermal Characteristics

Characteristic	Symbol	Value	Unit
Typical Thermal Resistance, Junction to Case	R _{θJC}	1.1	°C/W
Operating Temperature Range	T _J	-55 to +175	°C
Storage Temperature Range	T _{STG}	-55 to +175	°C

Notes: 6. Valid provided that terminals are kept at ambient temperature.
 7. Measured on 8.3ms single half sine-wave or equivalent square wave. Duty cycle = 4 pulses per minute maximum.

Electrical Characteristics (@T_A = +25°C, unless otherwise specified.)

Part Number	Reverse Standoff Voltage	Breakdown Voltage V _{BR} @ I _T (Note 8)		Test Current	Max. Reverse Leakage @ V _{RWM} (Note 10)	Max. Clamping Voltage @ I _{pp}	Max. Peak Pulse Current I _{pp} at 10/1000µs (Note 9)	Maximum Leakage at V _{WM} T _J = +175°C
	V _{RWM} (V)	Min (V)	Max (V)	I _T (mA)	I _R (µA)	V _C (V)	(A)	I _D (µA)
DM5W10AQ	10	11.1	12.3	5	15	17.0	211	250
DM5W11AQ	11	12.2	13.5	5	10	18.2	198	150
DM5W12AQ	12	13.3	14.7	5	10	19.9	181	150
DM5W13AQ	13	14.4	15.9	5	10	21.5	167	150
DM5W14AQ	14	15.6	17.2	5	10	23.2	155	150
DM5W15AQ	15	16.7	18.5	5	10	24.2	148	150
DM5W16AQ	16	17.8	19.7	5	10	26.0	138	150
DM5W17AQ	17	18.9	20.9	5	10	27.6	130	150
DM5W18AQ	18	20.0	22.1	5	10	29.2	123	150
DM5W20AQ	20	22.2	24.5	5	10	32.4	111	150
DM5W22AQ	22	24.4	26.9	5	10	35.5	101	150
DM5W24AQ	24	26.7	29.5	5	10	38.9	93	150
DM5W26AQ	26	28.9	31.9	5	10	42.1	86	150
DM5W28AQ	28	31.1	34.4	5	10	45.4	79	150
DM5W30AQ	30	33.3	36.8	5	10	48.4	74	150
DM5W33AQ	33	36.7	40.6	5	10	53.3	68	150
DM5W36AQ	36	40.0	44.2	5	10	58.1	62	150
DM5W40AQ	40	44.4	49.1	5	10	64.5	56	150
DM5W43AQ	43	47.8	52.8	5	10	69.4	52	150

- Notes:
- 8. V_{BR} measured with I_T current pulse = 10ms to 15ms.
 - 9. Refer to Figure 3 for the waveform.
 - 10. Short duration pulse test used to minimize the self-heating effect.

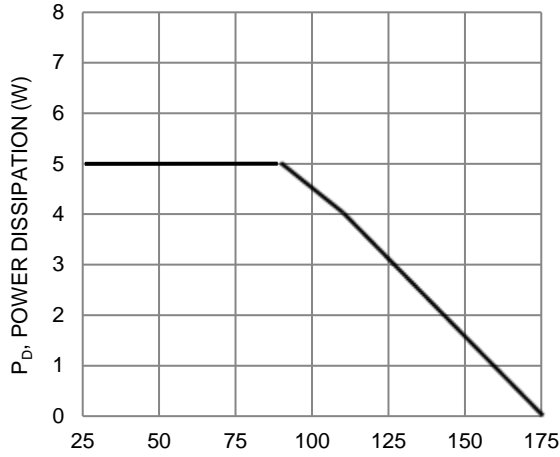

Fig. 1 Power Derating Curve

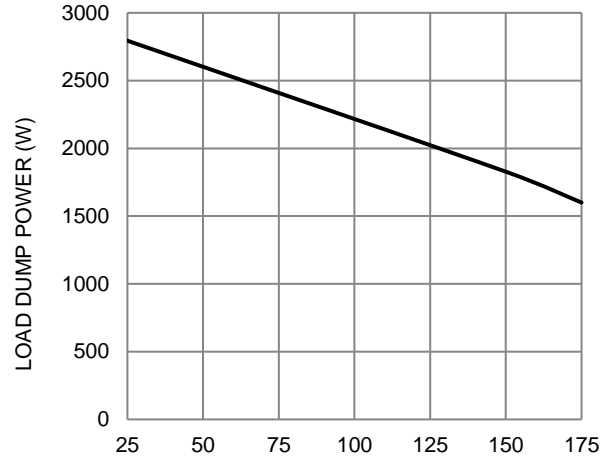

Fig. 2 Load Dump Power Characteristics (10ms Exponential Waveform)

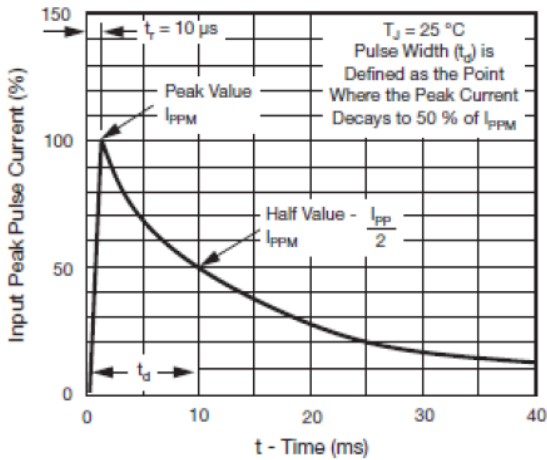

Fig. 3 - Pulse Waveform



Fig. 4 Reverse Power Capability

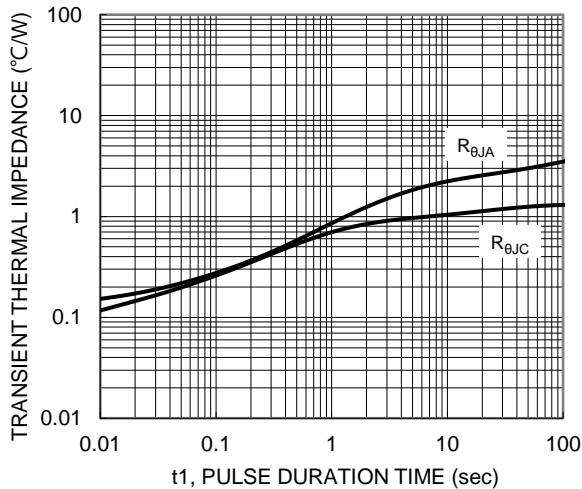

Fig. 5 Typical Transient Thermal Impedance

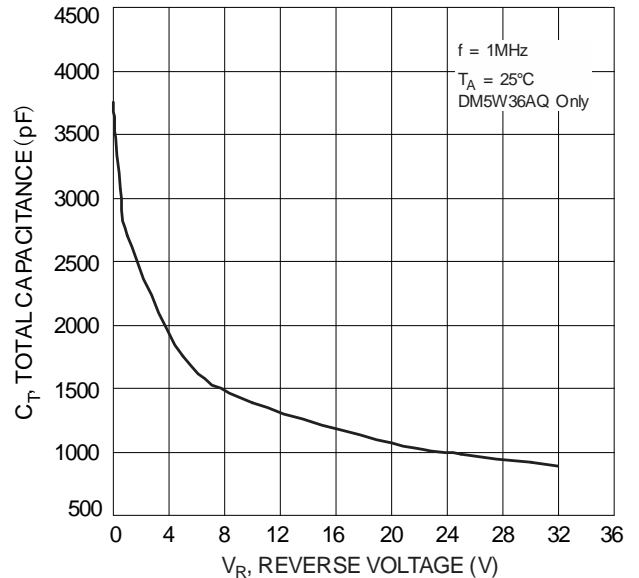
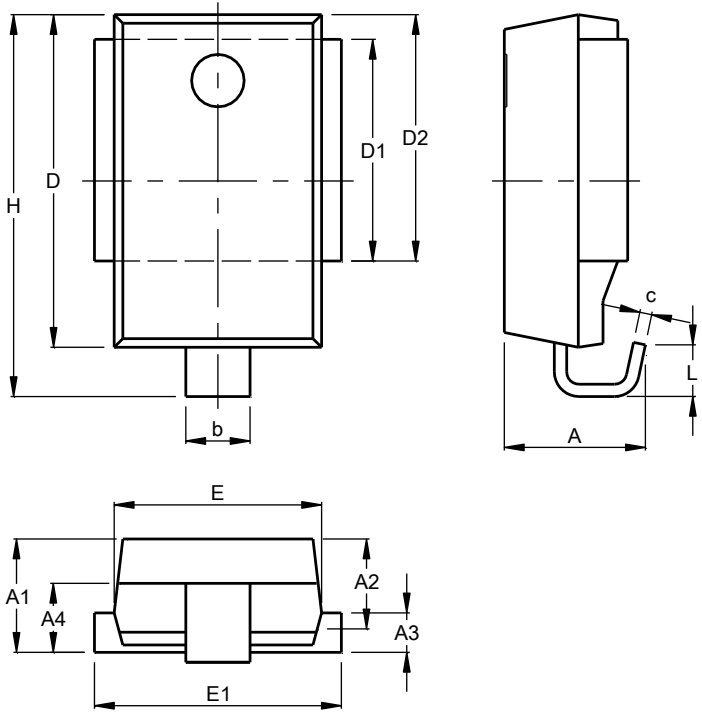

Fig. 6 Typical Total Capacitance

Package Outline Dimensions

Please see <http://www.diodes.com/package-outlines.html> for the latest version.

DO-218 (Type E)



DO-218 (Type E)			
Dim	Min	Max	Typ
A	4.70	5.70	--
A1	4.70	5.25	5.00
A2	3.45	4.26	3.95
A3	1.70	2.50	2.00
A4	2.58	3.55	3.10
b	2.30	3.00	--
c	0.45	0.90	--
D	13.20	13.80	13.50
D1	8.70	9.30	9.00
D2	9.70	10.30	10.00
E	8.20	8.80	8.50
E1	9.50	10.50	--
H	15.00	16.00	15.50
L	1.50	2.50	2.00
All Dimensions in mm			

Suggested Pad Layout

Please see <http://www.diodes.com/package-outlines.html> for the latest version.

DO-218 (Type E)

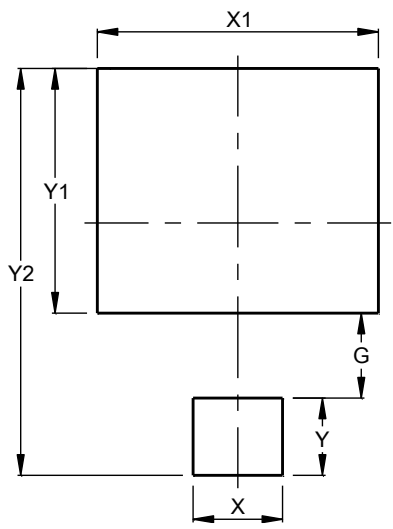

Dimensions	Value (in mm)
G	3.30
X	3.50
X1	11.00
Y	3.00
Y1	9.50
Y2	15.80

IMPORTANT NOTICE

1. DIODES INCORPORATED AND ITS SUBSIDIARIES ("DIODES") MAKE NO WARRANTY OF ANY KIND, EXPRESS OR IMPLIED, WITH REGARDS TO ANY INFORMATION CONTAINED IN THIS DOCUMENT, INCLUDING, BUT NOT LIMITED TO, THE IMPLIED WARRANTIES OF MERCHANTABILITY, FITNESS FOR A PARTICULAR PURPOSE OR NON-INFRINGEMENT OF THIRD PARTY INTELLECTUAL PROPERTY RIGHTS (AND THEIR EQUIVALENTS UNDER THE LAWS OF ANY JURISDICTION).
2. The Information contained herein is for informational purpose only and is provided only to illustrate the operation of Diodes products described herein and application examples. Diodes does not assume any liability arising out of the application or use of this document or any product described herein. This document is intended for skilled and technically trained engineering customers and users who design with Diodes products. Diodes products may be used to facilitate safety-related applications; however, in all instances customers and users are responsible for (a) selecting the appropriate Diodes products for their applications, (b) evaluating the suitability of the Diodes products for their intended applications, (c) ensuring their applications, which incorporate Diodes products, comply the applicable legal and regulatory requirements as well as safety and functional-safety related standards, and (d) ensuring they design with appropriate safeguards (including testing, validation, quality control techniques, redundancy, malfunction prevention, and appropriate treatment for aging degradation) to minimize the risks associated with their applications.
3. Diodes assumes no liability for any application-related information, support, assistance or feedback that may be provided by Diodes from time to time. Any customer or user of this document or products described herein will assume all risks and liabilities associated with such use, and will hold Diodes and all companies whose products are represented herein or on Diodes' websites, harmless against all damages and liabilities.
4. Products described herein may be covered by one or more United States, international or foreign patents and pending patent applications. Product names and markings noted herein may also be covered by one or more United States, international or foreign trademarks and trademark applications. Diodes does not convey any license under any of its intellectual property rights or the rights of any third parties (including third parties whose products and services may be described in this document or on Diodes' website) under this document.
5. Diodes products are provided subject to Diodes' Standard Terms and Conditions of Sale (<https://www.diodes.com/about/company/terms-and-conditions/terms-and-conditions-of-sales/>) or other applicable terms. This document does not alter or expand the applicable warranties provided by Diodes. Diodes does not warrant or accept any liability whatsoever in respect of any products purchased through unauthorized sales channel.
6. Diodes products and technology may not be used for or incorporated into any products or systems whose manufacture, use or sale is prohibited under any applicable laws and regulations. Should customers or users use Diodes products in contravention of any applicable laws or regulations, or for any unintended or unauthorized application, customers and users will (a) be solely responsible for any damages, losses or penalties arising in connection therewith or as a result thereof, and (b) indemnify and hold Diodes and its representatives and agents harmless against any and all claims, damages, expenses, and attorney fees arising out of, directly or indirectly, any claim relating to any noncompliance with the applicable laws and regulations, as well as any unintended or unauthorized application.
7. While efforts have been made to ensure the information contained in this document is accurate, complete and current, it may contain technical inaccuracies, omissions and typographical errors. Diodes does not warrant that information contained in this document is error-free and Diodes is under no obligation to update or otherwise correct this information. Notwithstanding the foregoing, Diodes reserves the right to make modifications, enhancements, improvements, corrections or other changes without further notice to this document and any product described herein. This document is written in English but may be translated into multiple languages for reference. Only the English version of this document is the final and determinative format released by Diodes.
8. Any unauthorized copying, modification, distribution, transmission, display or other use of this document (or any portion hereof) is prohibited. Diodes assumes no responsibility for any losses incurred by the customers or users or any third parties arising from any such unauthorized use.

Copyright © 2022 Diodes Incorporated

www.diodes.com

Mouser Electronics

Authorized Distributor

Click to View Pricing, Inventory, Delivery & Lifecycle Information:

[Diodes Incorporated:](#)

[DM5W12AQ-13](#)