

**Product Summary** (@T<sub>A</sub> = +25°C)

P <sub>PK</sub>	I <sub>FSM</sub> (A)	V <sub>RWM</sub> (V)	PM <sub>(AV)</sub>
3600W	500	10 to 36	5W

**Features and Benefits**

- 3600W Peak Pulse Power Dissipation
- High Current Capability
- Glass Passivated Die Construction
- Low Reverse Current
- Low Thermal Resistance
- Low Power Loss and High Efficiency
- Excellent High Temperature Stability
- Meets ISO7637-2 Surge Capability
- Meets ISO16750-2 Surge Specification
- **Lead-Free Finish; RoHS Compliant (Notes 1 & 2)**
- **Halogen and Antimony Free. "Green" Device (Note 3)**
- **Qualified to AEC-Q101 Standards for High Reliability**
- **An Automotive-Compliant Part is Available Under Separate Datasheet ([DM5W10AQ-DM5W36AQ](#))**

**Description and Applications**

Suitable to protect sensitive automotive circuits against surges defined in ISO7637-2 and against load dump surge according to ISO16750-2.

Compliance with following standards

- ISO 16750-2, Pulse A and Pulse B
- ISO 7637-2 (Note 5)  
Pulse 1, Pulse 2a, Pulse 3a, Pulse 3b

**Mechanical Data**

- Case: DO-218 (Type E)
- Case Material: Molded Plastic.  
UL Flammability Classification Rating 94V-0
- Moisture Sensitivity: Level 1 per J-STD-020
- Terminals: Lead-Free Plating (Matte Tin Finish).
- Solderable per MIL-STD-202, Method 208 Ⓔ3
- Polarity Indicator: Heatsink is Anode
- Weight: 2.74 grams (Approximate)

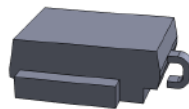
**DO-218 (Type E)**

Top View

Polarity: Heatsink is anode

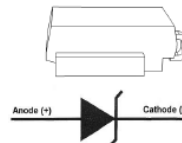

Pin Information

**Ordering Information** (Note 4)

Part Number	Qualification	Case	Packaging
DM5WxxA-13	AEC-Q101	DO-218 (Type E)	750/Tape & Reel

\*x = Device Voltage, e.g., DM5W10A-13

- Notes:
1. EU Directive 2002/95/EC (RoHS), 2011/65/EU (RoHS 2) & 2015/863/EU (RoHS 3) compliant. All applicable RoHS exemptions applied.
  2. See <https://www.diodes.com/quality/lead-free/> for more information about Diodes Incorporated's definitions of Halogen- and Antimony-free, "Green" and Lead-free.
  3. Halogen- and Antimony-free "Green" products are defined as those which contain <900ppm bromine, <900ppm chlorine (<1500ppm total Br + Cl) and <1000ppm antimony compounds.
  4. For packaging details, go to our website at <https://www.diodes.com/design/support/packaging/diodes-packaging/>.
  5. Not applicable to parts with stand-off voltage lower than the average battery voltage (13.5V).

**Marking Information**

M5WxxA = Product Type Marking Code (i.e. M5W10A for DM5W10A-13)  
 J;I = Manufacturers' Code Marking  
 YWW = Date Code Marking  
 Y = Last Digit of Year (ex: 8 for 2018)  
 WW = Week Code (01 to 53)  
 Bar Denotes Cathode Pin, Circle Denotes Anode

**Maximum Ratings** (@T<sub>A</sub> = +25°C, unless otherwise specified.)

Characteristic	Symbol	Value	Unit
Peak Pulse Power Dissipation (Non Repetitive Current Pulse Derated above T <sub>A</sub> = +25°C) (Note 6)	P <sub>PK</sub>	10/1000µs Waveform	3600
		10/10000µs Waveform	2800
Peak Forward Surge Current, 8.3ms Single Half Sine-Wave Superimposed on Rated Load (Notes 6 & 7)	I <sub>FSM</sub>	500	A
Steady State Power Dissipation @ T <sub>C</sub> = +25°C	PM <sub>(AV)</sub>	5.0	W

**Thermal Characteristics**

Characteristic	Symbol	Value	Unit
Typical Thermal Resistance, Junction to Case	R <sub>θJC</sub>	1.1	°C/W
Operating Temperature Range	T <sub>J</sub>	-55 to +175	°C
Storage Temperature Range	T <sub>STG</sub>	-55 to +175	°C

Notes: 6. Valid provided that terminals are kept at ambient temperature.  
7. Measured on 8.3ms single half sine-wave or equivalent square wave. Duty cycle = 4 pulses per minute maximum.

**Electrical Characteristics** (@T<sub>A</sub> = +25°C, unless otherwise specified.)

Part Number	Reverse Standoff Voltage	Breakdown Voltage V <sub>BR</sub> @ I <sub>T</sub> (Note 8)		Test Current	Max. Reverse Leakage @ V <sub>RWM</sub>	Max. Clamping Voltage @ I <sub>pp</sub>	Max. Peak Pulse Current I <sub>pp</sub> at 10/1000µs (Note 9)	Maximum Leakage at V <sub>WM</sub> T <sub>J</sub> = +175°C
	V <sub>RWM</sub> (V)	Min (V)	Max (V)	I <sub>T</sub> (mA)	I <sub>R</sub> (µA)	V <sub>C</sub> (V)	(A)	I <sub>D</sub> (µA)
DM5W10A	10	11.1	12.3	5	15	17.0	211	250
DM5W11A	11	12.2	13.5	5	10	18.2	198	150
DM5W12A	12	13.3	14.7	5	10	19.9	181	150
DM5W13A	13	14.4	15.9	5	10	21.5	167	150
DM5W14A	14	15.6	17.2	5	10	23.2	155	150
DM5W15A	15	16.7	18.5	5	10	24.4	148	150
DM5W16A	16	17.8	19.7	5	10	26.0	138	150
DM5W17A	17	18.9	20.9	5	10	27.6	130	150
DM5W18A	18	20.0	22.1	5	10	29.2	123	150
DM5W20A	20	22.2	24.5	5	10	32.4	111	150
DM5W22A	22	24.4	26.9	5	10	35.5	101	150
DM5W24A	24	26.7	29.5	5	10	38.9	93	150
DM5W26A	26	28.9	31.9	5	10	42.1	86	150
DM5W28A	28	31.1	34.4	5	10	45.4	79	150
DM5W30A	30	33.3	36.8	5	10	48.4	74	150
DM5W33A	33	36.7	40.6	5	10	53.3	68	150
DM5W36A	36	40.0	44.2	5	10	58.1	61	150

Notes: 8. V<sub>BR</sub> measured with I<sub>T</sub> current pulse = 10ms to 15ms.  
9. Refer to Figure 3 for the waveform.

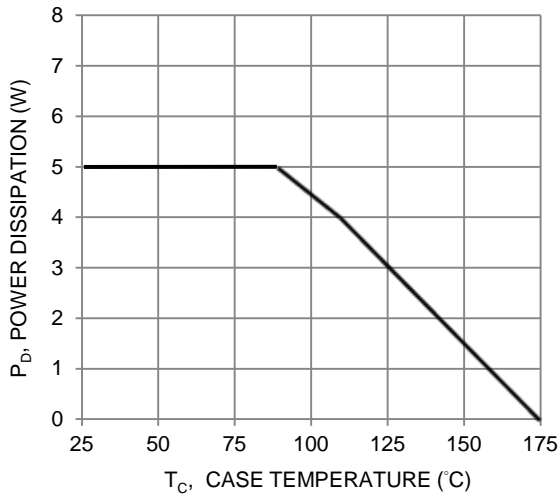

T<sub>C</sub>, CASE TEMPERATURE (°C)  
Fig. 1 Power Derating Curve

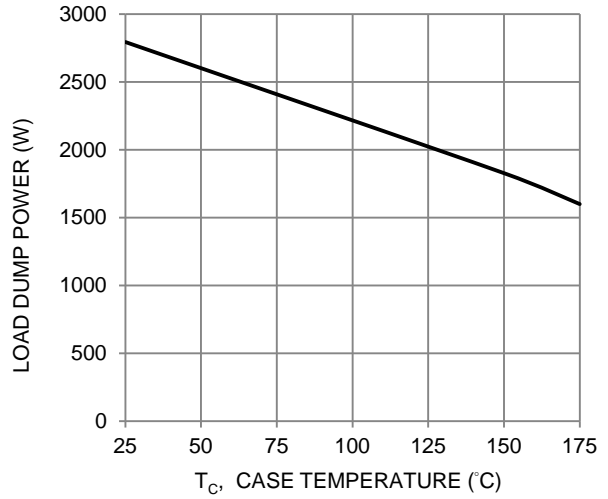

T<sub>C</sub>, CASE TEMPERATURE (°C)  
Fig. 2 Load Dump Power Characteristics  
(10ms Exponential Waveform)

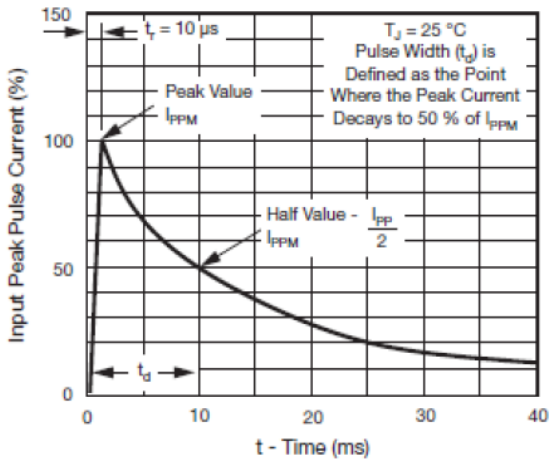

Fig. 3 - Pulse Waveform

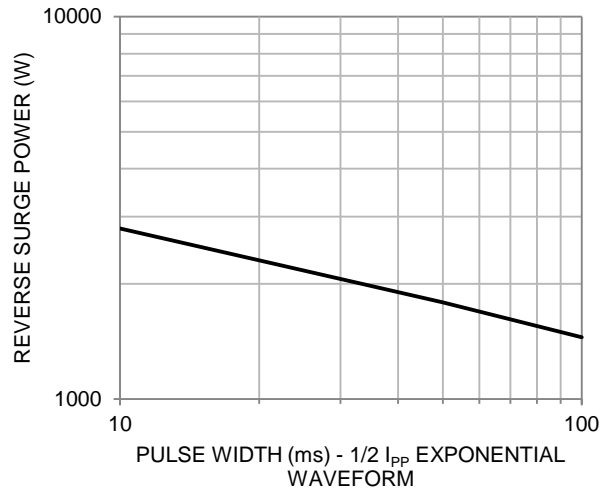

Fig. 4 Reverse Power Capability

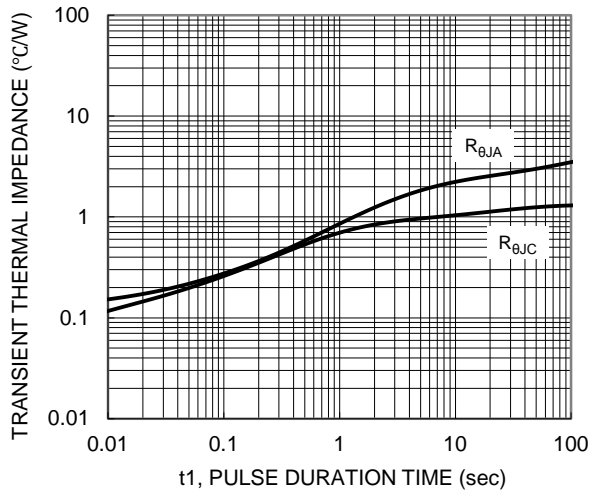

Fig. 5 Typical Transient Thermal Impedance

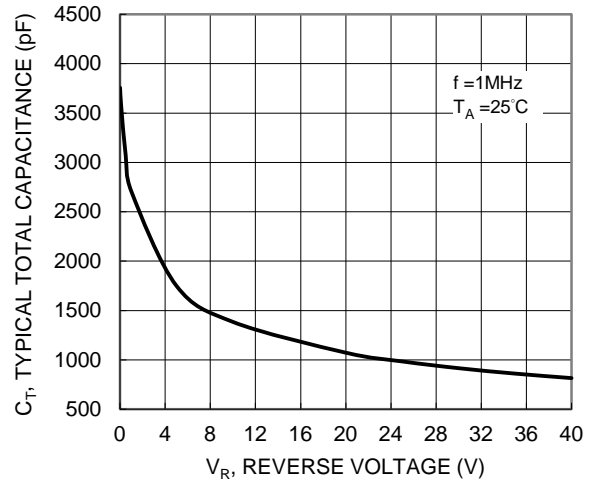

Fig. 6 Typical Total Capacitance

NEW PRODUCT

**Package Outline Dimensions**

Please see <http://www.diodes.com/package-outlines.html> for the latest version.

**DO-218 (Type E)**

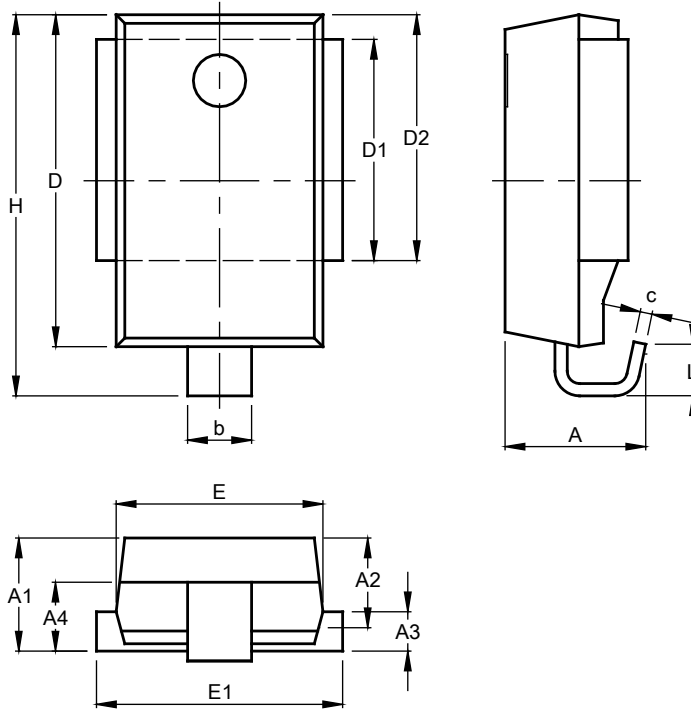

DO-218 (Type E)			
Dim	Min	Max	Typ
A	4.70	5.70	--
A1	4.70	5.25	5.00
A2	3.45	4.25	3.95
A3	1.70	2.50	2.00
A4	2.65	3.55	3.10
b	2.30	3.00	--
c	0.45	0.90	--
D	13.20	13.80	13.50
D1	8.70	9.30	9.00
D2	9.70	10.30	10.00
E	8.20	8.80	8.50
E1	9.50	10.00	--
H	15.00	16.00	15.50
L	1.50	2.50	2.00
All Dimensions in mm			

**Suggested Pad Layout**

Please see <http://www.diodes.com/package-outlines.html> for the latest version.

**DO-218 (Type E)**

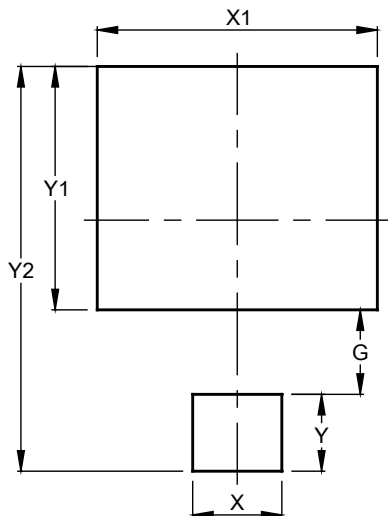

Dimensions	Value (in mm)
G	3.30
X	3.50
X1	11.00
Y	3.00
Y1	9.50
Y2	15.80

**IMPORTANT NOTICE**

DIODES INCORPORATED MAKES NO WARRANTY OF ANY KIND, EXPRESS OR IMPLIED, WITH REGARDS TO THIS DOCUMENT, INCLUDING, BUT NOT LIMITED TO, THE IMPLIED WARRANTIES OF MERCHANTABILITY AND FITNESS FOR A PARTICULAR PURPOSE (AND THEIR EQUIVALENTS UNDER THE LAWS OF ANY JURISDICTION).

Diodes Incorporated and its subsidiaries reserve the right to make modifications, enhancements, improvements, corrections or other changes without further notice to this document and any product described herein. Diodes Incorporated does not assume any liability arising out of the application or use of this document or any product described herein; neither does Diodes Incorporated convey any license under its patent or trademark rights, nor the rights of others. Any Customer or user of this document or products described herein in such applications shall assume all risks of such use and will agree to hold Diodes Incorporated and all the companies whose products are represented on Diodes Incorporated website, harmless against all damages.

Diodes Incorporated does not warrant or accept any liability whatsoever in respect of any products purchased through unauthorized sales channel. Should Customers purchase or use Diodes Incorporated products for any unintended or unauthorized application, Customers shall indemnify and hold Diodes Incorporated and its representatives harmless against all claims, damages, expenses, and attorney fees arising out of, directly or indirectly, any claim of personal injury or death associated with such unintended or unauthorized application.

Products described herein may be covered by one or more United States, international or foreign patents pending. Product names and markings noted herein may also be covered by one or more United States, international or foreign trademarks.

This document is written in English but may be translated into multiple languages for reference. Only the English version of this document is the final and determinative format released by Diodes Incorporated.

**LIFE SUPPORT**

Diodes Incorporated products are specifically not authorized for use as critical components in life support devices or systems without the express written approval of the Chief Executive Officer of Diodes Incorporated. As used herein:

A. Life support devices or systems are devices or systems which:

1. are intended to implant into the body, or
2. support or sustain life and whose failure to perform when properly used in accordance with instructions for use provided in the labeling can be reasonably expected to result in significant injury to the user.

B. A critical component is any component in a life support device or system whose failure to perform can be reasonably expected to cause the failure of the life support device or to affect its safety or effectiveness.

Customers represent that they have all necessary expertise in the safety and regulatory ramifications of their life support devices or systems, and acknowledge and agree that they are solely responsible for all legal, regulatory and safety-related requirements concerning their products and any use of Diodes Incorporated products in such safety-critical, life support devices or systems, notwithstanding any devices- or systems-related information or support that may be provided by Diodes Incorporated. Further, Customers must fully indemnify Diodes Incorporated and its representatives against any damages arising out of the use of Diodes Incorporated products in such safety-critical, life support devices or systems.

Copyright © 2019, Diodes Incorporated

[www.diodes.com](http://www.diodes.com)

# Mouser Electronics

Authorized Distributor

Click to View Pricing, Inventory, Delivery & Lifecycle Information:

## Diodes Incorporated:

[DM5W10A-13](#) [DM5W11A-13](#) [DM5W12A-13](#) [DM5W13A-13](#) [DM5W14A-13](#) [DM5W24A-13](#) [DM5W26A-13](#)  
[DM5W28A-13](#) [DM5W30A-13](#) [DM5W33A-13](#) [DM5W36A-13](#) [DM5W15A-13](#) [DM5W16A-13](#) [DM5W17A-13](#) [DM5W18A-13](#) [DM5W20A-13](#) [DM5W22A-13](#)