

IS280GR / IS280-4GR



DESCRIPTION

The IS280GR single channel and IS280-4GR quad channel optocouplers each channel consist of two infrared emitting diodes in reverse parallel connection optically coupled to an NPN silicon photo transistor.

These devices belong to Isocom Compact Range of Optocouplers.

FEATURES

- Half Pitch 1.27mm
- High AC Isolation voltage 3750V_{RMS}
- Wide Operating Temperature Range -55°C to 110°C
- Pb Free and RoHS Compliant
- UL Approval E91231 Model "AHP"

APPLICATIONS

- Hybrid Substrates with High Density Mounting
- Industrial System Controllers
- Measuring Instruments
- System Appliances

ORDER INFORMATION

- Available in Tape and Reel
 IS280GR : 3000pcs per reel
 IS280-4GR : 2000pcs per reel

IS280GR

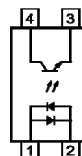

IS280-4GR

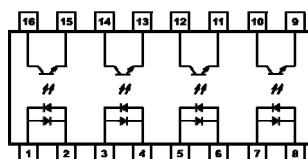

IS280GR	1	Anode / Cathode	3	Emitter
	2	Cathode / Anode	4	Collector
IS280-4GR	1, 3, 5, 7	Anode / Cathode	9, 11, 13, 15	Emitter
	2, 4, 6, 8	Cathode / Anode	10, 12, 14, 16	Collector

ABSOLUTE MAXIMUM RATINGS (T_A = 25°C)

Stresses exceeding the absolute maximum ratings can cause permanent damage to the device. Exposure to absolute maximum ratings for long periods of time can adversely affect reliability.

Input

Forward Current	±50mA
Power dissipation	65mW

Output

Collector to Emitter Voltage BV _{CEO}	80V
Emitter to Collector Voltage BV _{ECO}	7V
Collector Current	50mA
Junction Temperature	125°C
Power Dissipation	IS280GR 150mW IS280-4GR 100mW

Total Package

Isolation Voltage	3750V _{RMS}
Total Power Dissipation	IS280GR 200mW IS280-4GR 170mW
Operating Temperature	-55 to 110 °C
Storage Temperature	-55 to 150 °C
Lead Soldering Temperature (10s)	260°C

ISOCOM COMPONENTS 2004 LTD

Unit 25B, Park View Road West, Park View Industrial Estate
 Hartlepool, Cleveland, TS25 1PE, United Kingdom
 Tel : +44 (0)1429 863 609 Fax : +44 (0)1429 863 581
 e-mail : sales@isocom.co.uk
<http://www.isocom.com>

ISOCOM COMPONENTS ASIA LTD

Hong Kong Office
 Block A, 8/F, Wah Hing Industrial Mansions
 36 Tai Yau Street, San Po Kong, Kowloon, Hong Kong
 Tel : +852 2995 9217 Fax : +852 8161 6292
 e-mail : sales@isocom.com.hk

IS280GR / IS280-4GR

ELECTRICAL CHARACTERISTICS ($T_A = 25^\circ\text{C}$ unless otherwise specified)

INPUT

Parameter	Symbol	Test Condition	Min	Typ.	Max	Unit
Forward Voltage	V_F	$I_F = \pm 20\text{mA}$		1.2	1.4	V
Terminal Capacitance	C_{IN}	$V = 0\text{V}, f = 1\text{KHz}$		60		pF

OUTPUT

Parameter	Symbol	Test Condition	Min	Typ.	Max	Unit
Collector-Emitter Breakdown Voltage	BV_{CEO}	$I_C = 0.1\text{mA}, I_F = 0\text{mA}$	80			V
Emitter-Collector Breakdown Voltage	BV_{ECO}	$I_E = 10\mu\text{A}, I_F = 0\text{mA}$	7			V
Collector-Emitter Dark Current	I_{CEO}	$V_{CE} = 20\text{V}, I_F = 0\text{mA}$			100	nA

COUPLED

Parameter	Symbol	Test Condition	Min	Typ.	Max	Unit
Current transfer ratio	CTR	$I_F = \pm 1\text{mA}, V_{CE} = 5\text{V}$	100		300	%
Collector-Emitter Saturation Voltage	$V_{CE(sat)}$	$I_F = \pm 8\text{mA}, I_C = 2.4\text{mA}$			0.4	V
Floating Capacitance	C_f	$V_F = 0\text{V}, f = 1\text{MHz}$		0.8	1	pF
Output Rise Time	t_r	$V_{CE} = 2\text{V}$ $I_C = \pm 2\text{mA}$ $R_L = 100\Omega$		3	18	μs
Output Fall Time	t_f			4	18	

ISOLATION

Parameter	Symbol	Test Condition	Min	Typ.	Max	Unit
Isolation Voltage	V_{ISO}	R.H. = 40% to 60%, $t = 1\text{min}$ Note 1	3750			V_{RMS}
Input - Output Resistance	R_{I-O}	$V_{I-O} = 500\text{VDC}$ R.H. = 40% to 60% Note 1	5×10^{10}	1×10^{11}		Ω

Note 1 : Measured with input leads shorted together and output leads shorted together.

IS280GR / IS280-4GR

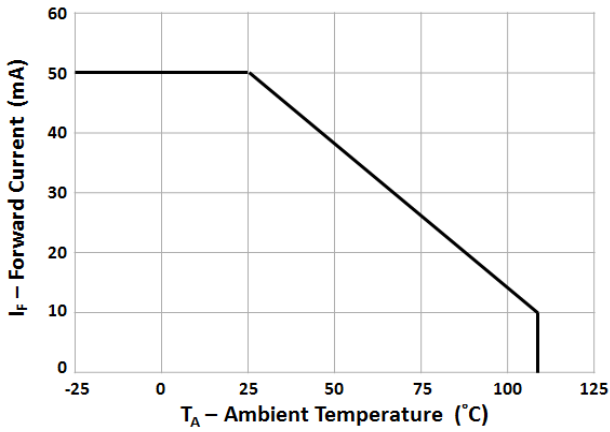

Fig 1 Forward Current vs Ambient Temperature

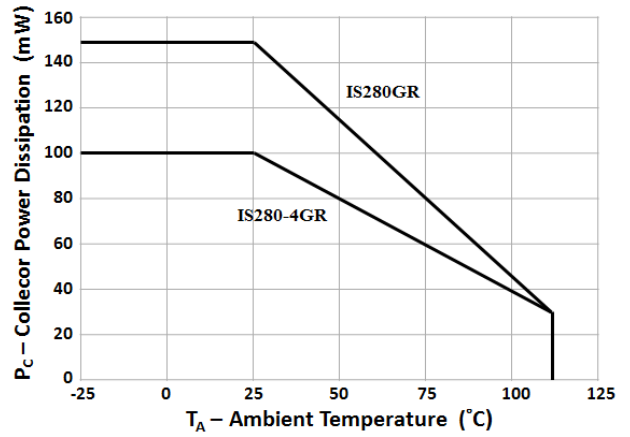

Fig 2 Output Power Dissipation vs Ambient Temperature

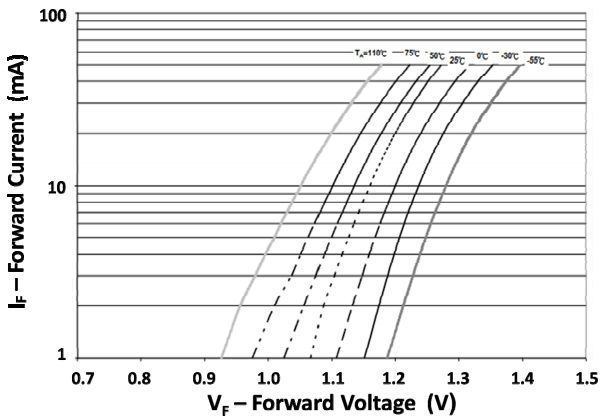

Fig 3 Forward Current vs Forward Voltage

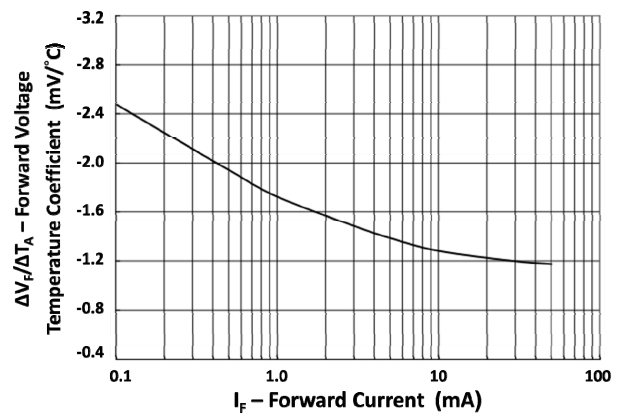

Fig 4 Forward Voltage Temperature Coefficient vs Forward Current

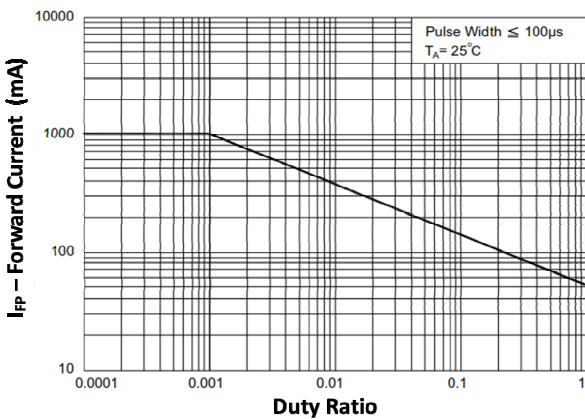

Fig 5 Pulsed Forward Current vs Duty Ratio

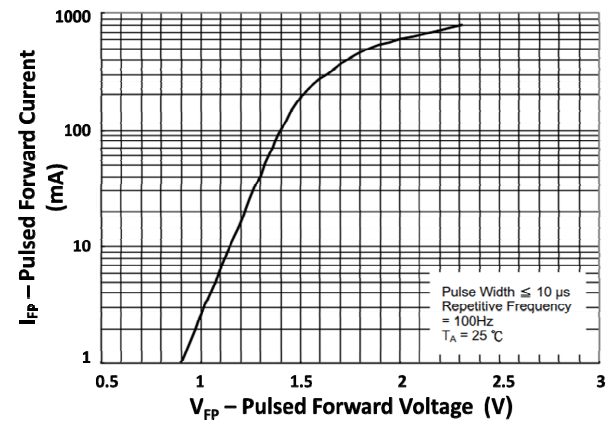

Fig 6 Pulsed Forward Current vs Pulsed Forward Voltage

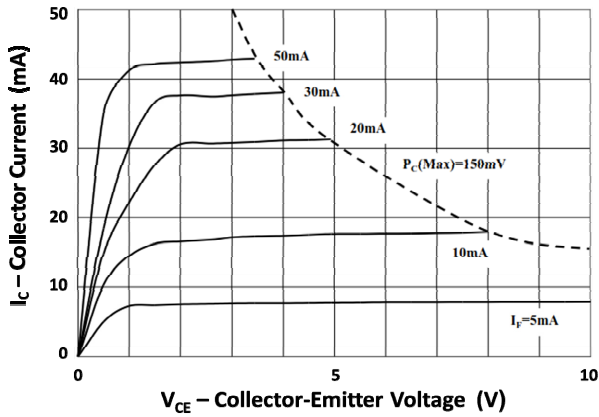

Fig 7 Collector Current vs Collector-Emitter Voltage (1)

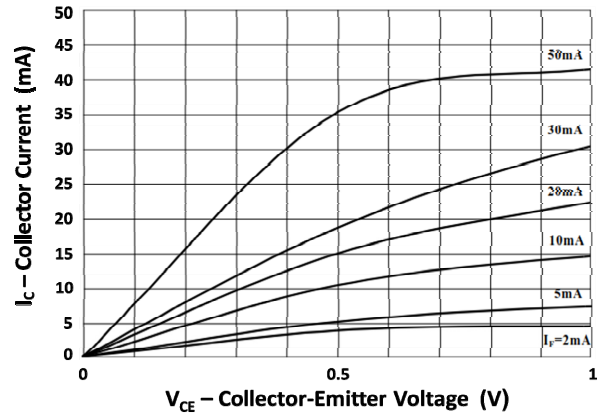

Fig 8 Collector Current vs Collector-Emitter Voltage (2)

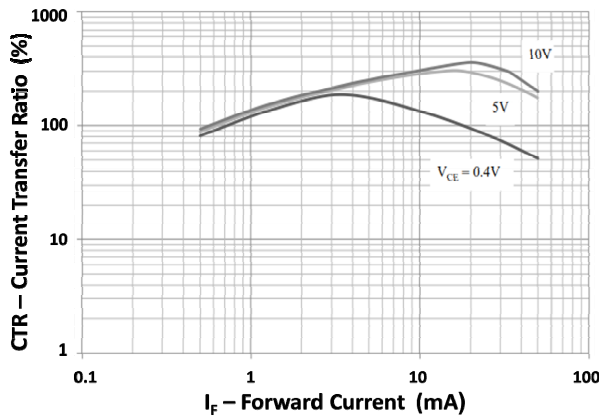

Fig 9 Current Transfer Ratio vs Forward Current

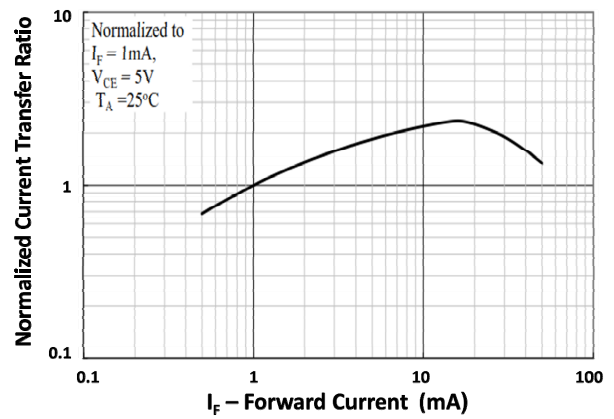

Fig 10 Normalized Current Transfer Ratio vs Forward Current

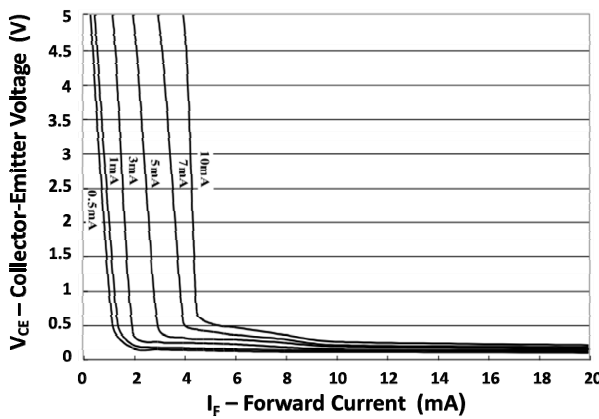

Fig 11 Collector-Emitter Voltage vs Forward Current

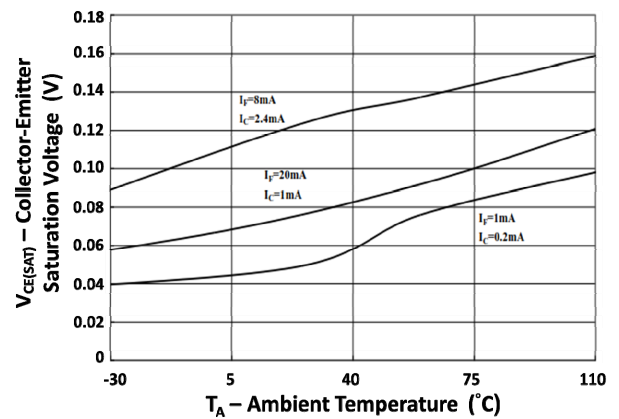

Fig 12 Collector-Emitter Saturation Voltage vs Ambient Temperature

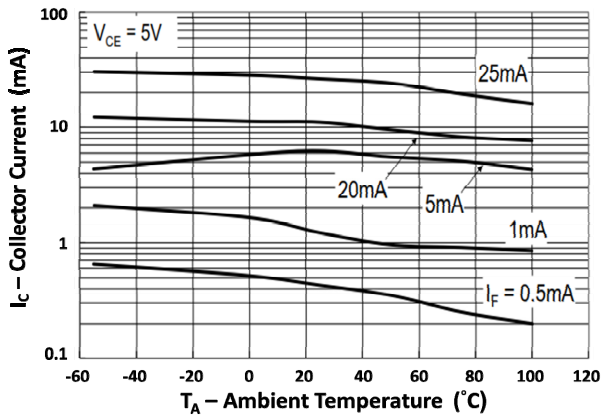

Fig 13 Collector Current vs Ambient Temperature

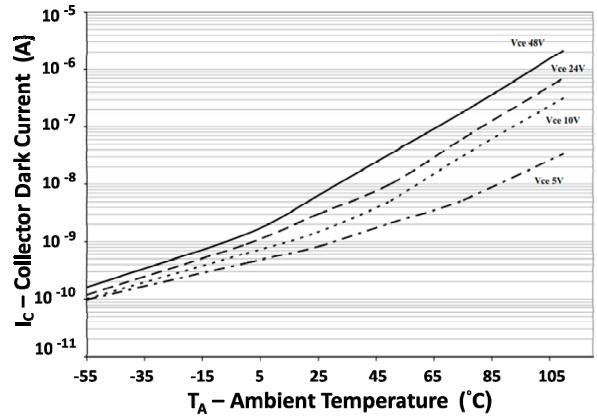

Fig 14 Collector Dark Current vs Ambient Temperature

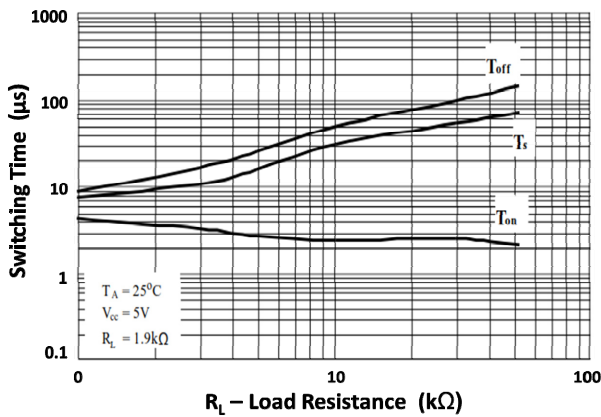

Fig 15 Switching Time vs Load Resistance

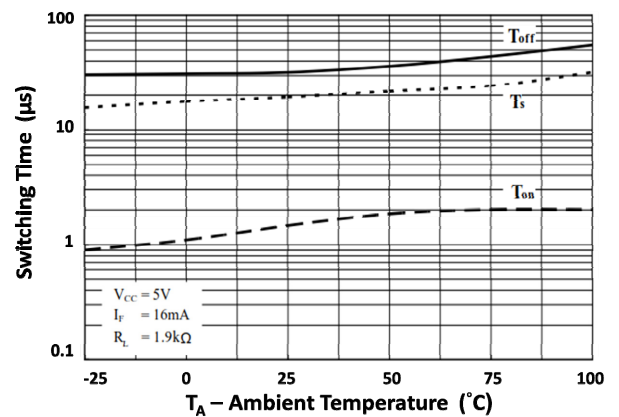

Fig 16 Switching Time vs Ambient Temperature

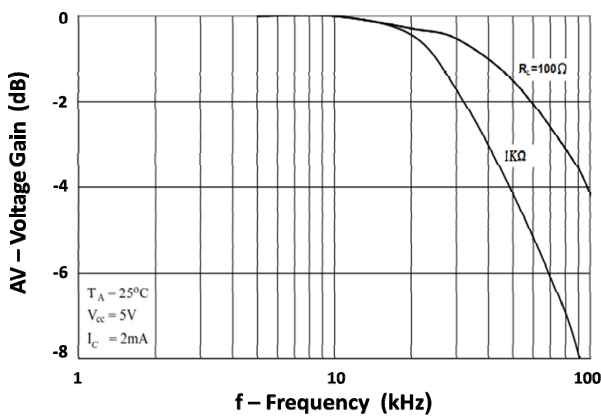
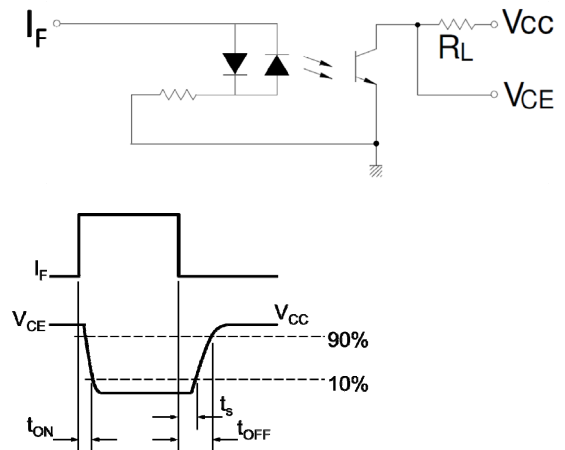

Fig 17 Frequency Response



Switching Time Test Circuit

IS280GR / IS280-4GR

ORDER INFORMATION

IS280GR, IS280-4GR			
After PN	PN	Description	Packing quantity
CTR Grade	IS280GR	Surface Mount Tape & Reel	3000 pcs per reel
CTR Grade	IS280-4GR	Surface Mount Tape & Reel	2000 pcs per reel

DEVICE MARKING

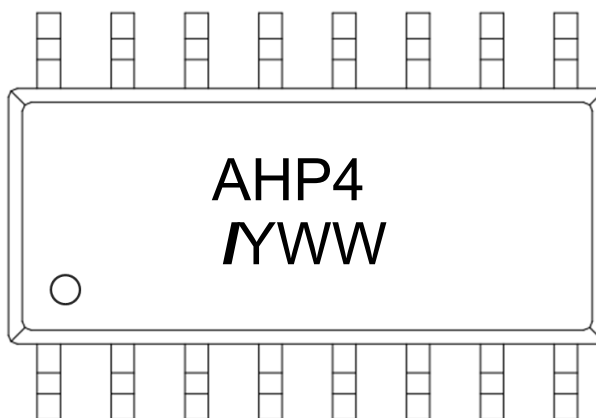
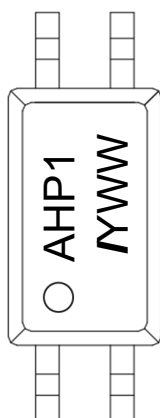

- | | |
|------|---------------------------|
| AHP1 | denotes IS280GR |
| AHP4 | denotes IS280GR-4 |
| I | denotes Isocom |
| Y | denotes 1 digit Year code |
| WW | denotes 2 digit Week code |

IS280GR / IS280-4GR

PACKAGE DIMENSIONS (mm)

IS280GR

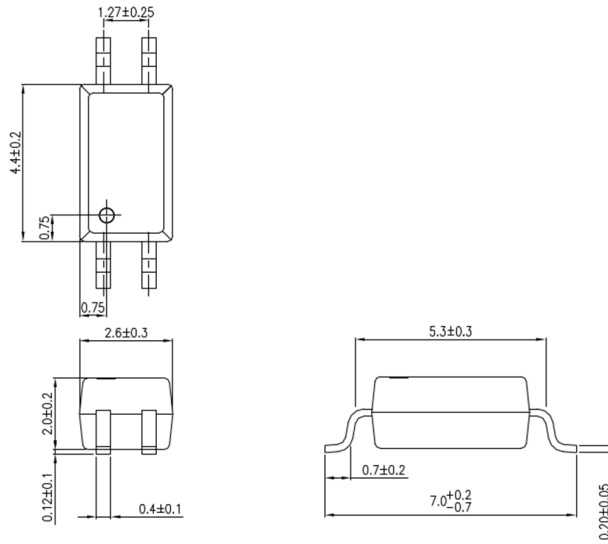

IS280-4GR

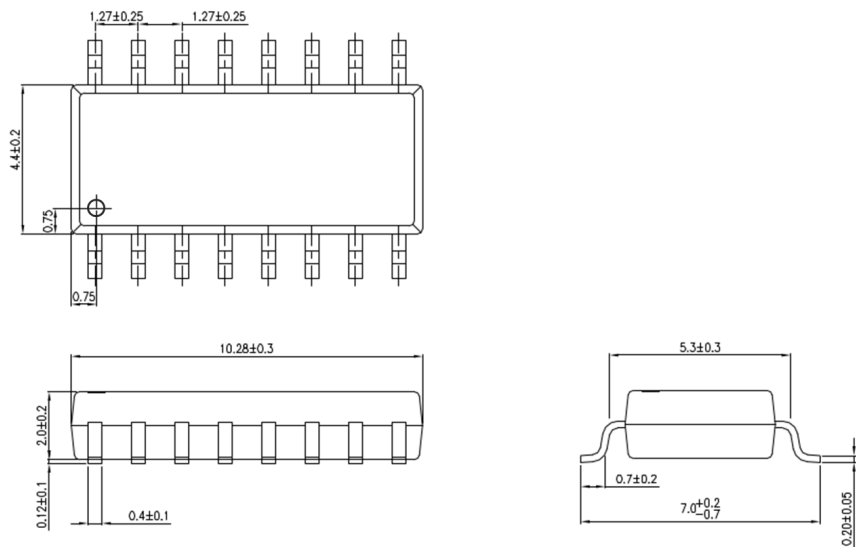

IS280GR / IS280-4GR

RECOMMENDED SOLDER PAD LAYOUT (mm)

IS280GR

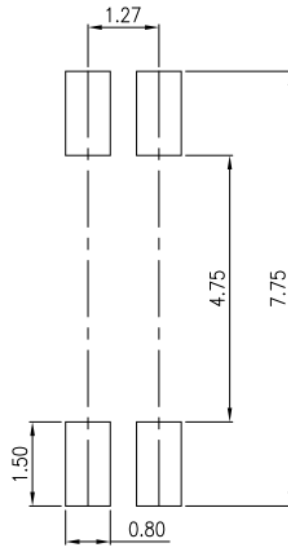

IS280-4GR

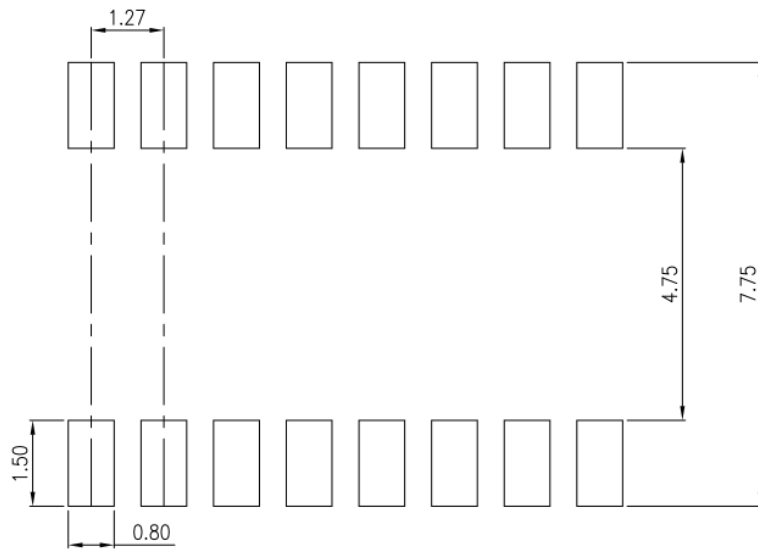

IS280GR / IS280-4GR

TAPE AND REEL PACKAGING

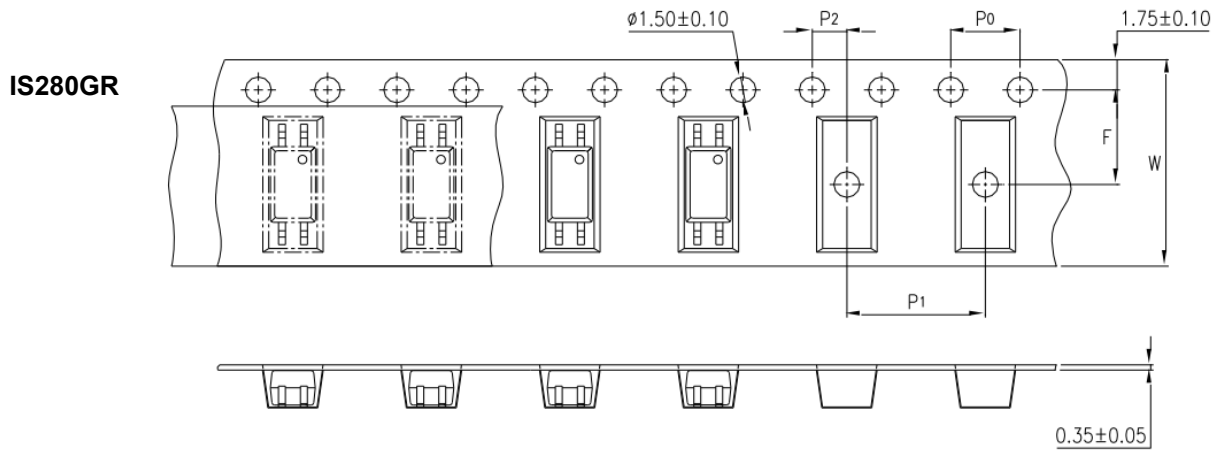

Description	Dimension	mm (inch)
Tape Width	W	12 ± 0.3 (0.47)
Pitch of Sprocket Holes	P0	4 ± 0.1 (0.15)
Distance of Compartment	F	5.5 ± 0.1 (0.217)
	P2	2 ± 0.1 (0.79)
Distance of Compartment to Compartment	P1	8 ± 0.1 (0.315)

IS280GR / IS280-4GR

TAPE AND REEL PACKAGING

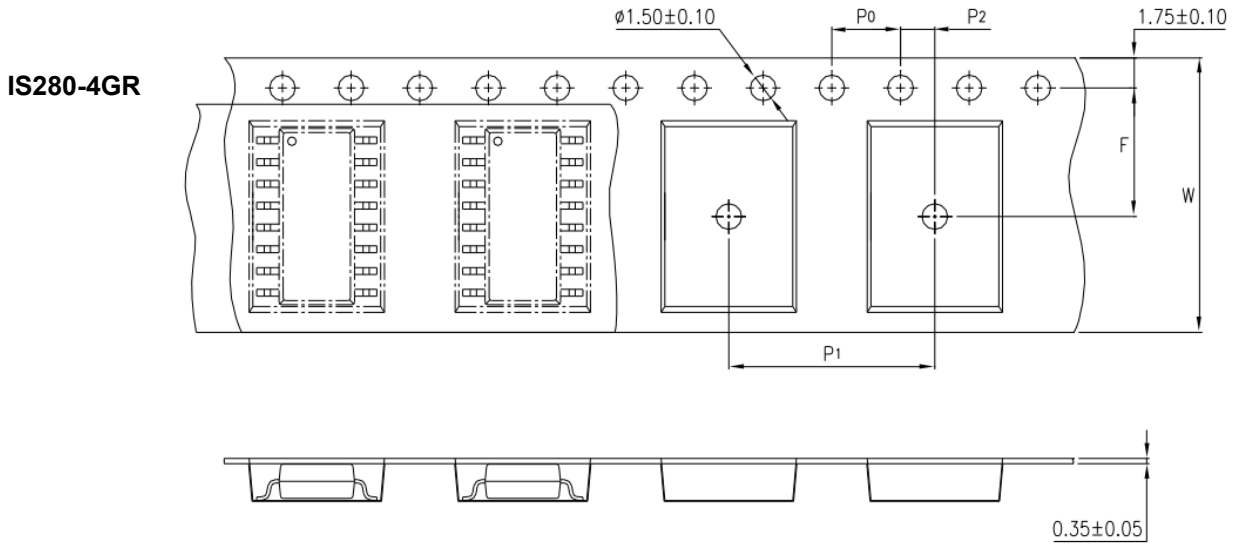

Description	Dimension	mm (inch)
Tape Width	W	16 ± 0.3 (0.63)
Pitch of Sprocket Holes	P0	4 ± 0.1 (0.15)
Distance of Compartment	F	7.5 ± 0.1 (0.295)
	P2	2 ± 0.1 (0.79)
Distance of Compartment to Compartment	P1	12 ± 0.1 (0.472)

IS280GR / IS280-4GR

IR REFLOW SOLDERING TEMPERATURE PROFILE

One Time Reflow Soldering is Recommended.
Do not immerse device body in solder paste.

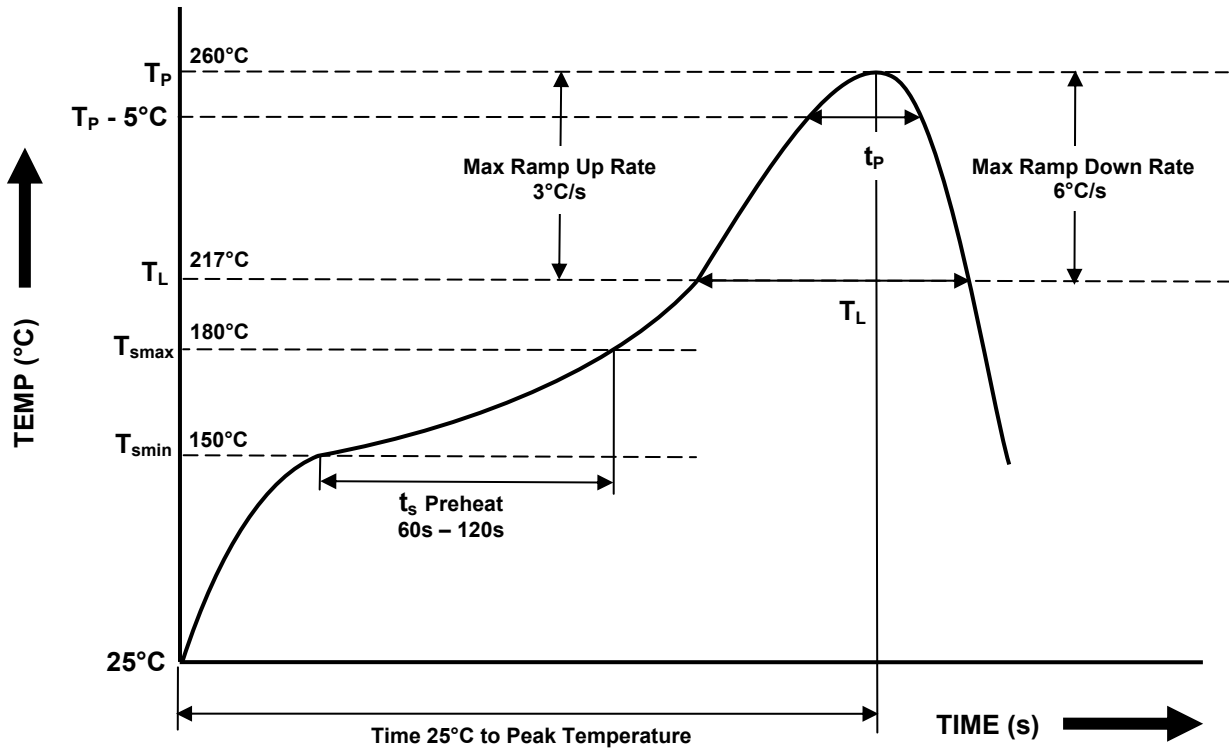

Profile Details	Conditions
Preheat - Min Temperature (T_{smin}) - Max Temperature (T_{smax}) - Time T_{smin} to T_{smax} (t_s)	150°C 180°C 60s - 120s
Soldering Zone - Peak Temperature (T_P) - Liquidous Temperature (T_L) - Time within 5°C of Actual Peak Temperature ($T_P - 5^\circ\text{C}$) - Time maintained above T_L (t_L) - Ramp Up Rate (T_L to T_P) - Ramp Down Rate (T_P to T_L)	260°C 217°C 20s 60s 3°C/s max 3 - 6°C/s
Average Ramp Up Rate (T_{smax} to T_P)	3°C/s max
Time 25°C to Peak Temperature	8 minutes max



DISCLAIMER

Isocom Components is continually working to improve the quality and reliability of its products. Nevertheless, semiconductor devices in general can malfunction or fail due to their inherent electrical sensitivity and vulnerability to physical stress. It is the responsibility of the buyer, when utilizing Isocom Components products, to comply with the standards of safety in making a safe design for the entire system, and to avoid situations in which a malfunction or failure of such Isocom Components products could cause loss of human life, bodily injury or damage to property.

In developing your designs, please ensure that Isocom Components products are used within specified operating ranges as set forth in the most recent Isocom Components products specifications.

The Isocom Components products listed in this document are intended for usage in general electronics applications (computer, personal equipment, office equipment, measuring equipment, industrial robotics, domestic appliances, etc.). These Isocom Components products are neither intended nor warranted for usage in equipment that requires extraordinarily high quality and/or reliability or a malfunction or failure of which may cause loss of human life or bodily injury ("Unintended Usage"). Unintended Usage include atomic energy control instruments, airplane or spaceship instruments, transportation Instruments, traffic signal instruments, combustion control instruments, medical Instruments, all types of safety devices, etc... Unintended Usage of Isocom Components products listed in this document shall be made at the customer's own risk.

Gallium arsenide (GaAs) is a substance used in the products described in this document. GaAs dust and fumes are toxic. Do not break, cut or pulverize the product, or use chemicals to dissolve them. When disposing of the products, follow the appropriate regulations. Do not dispose of the products with other industrial waste or with domestic garbage.

The products described in this document are subject to the foreign exchange and foreign trade laws.

The information contained herein is presented only as a guide for the applications of our products. No responsibility is assumed by Isocom Components for any infringements of intellectual property or other rights of the third parties which may result from its use. No license is granted by implication or otherwise under any intellectual property or other rights of Isocom Components or others.