

MAPX	MODIFICATION	DATE	DRAW	APPROVE

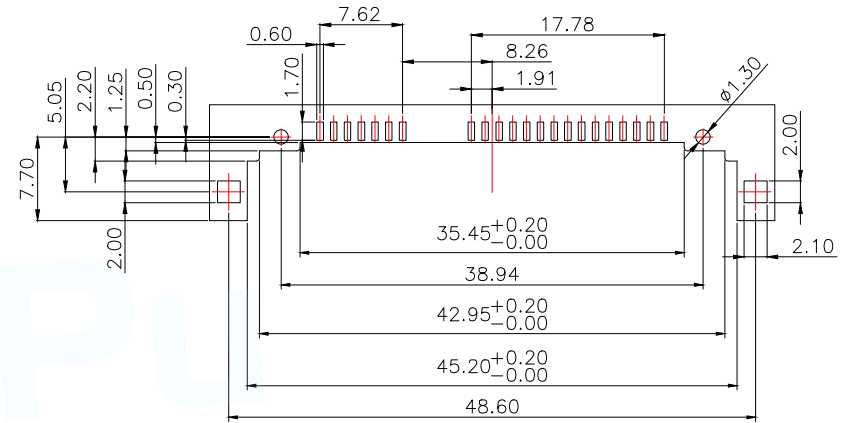

PCB LAYOUT TOLERANCES:±0.05mm

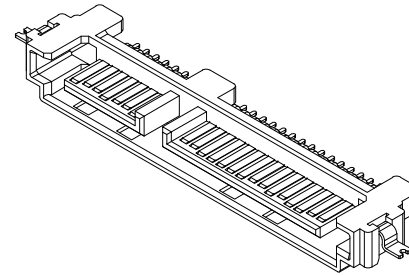
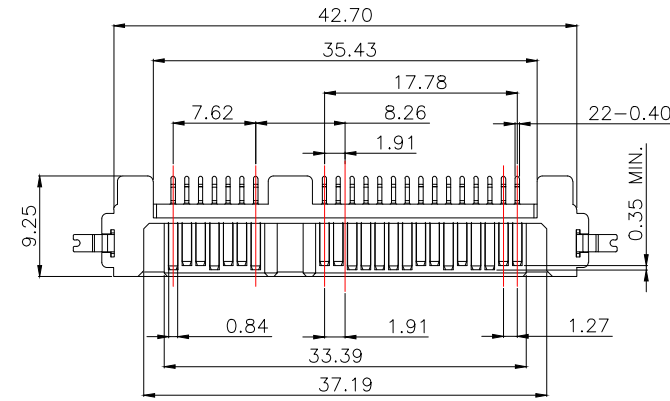
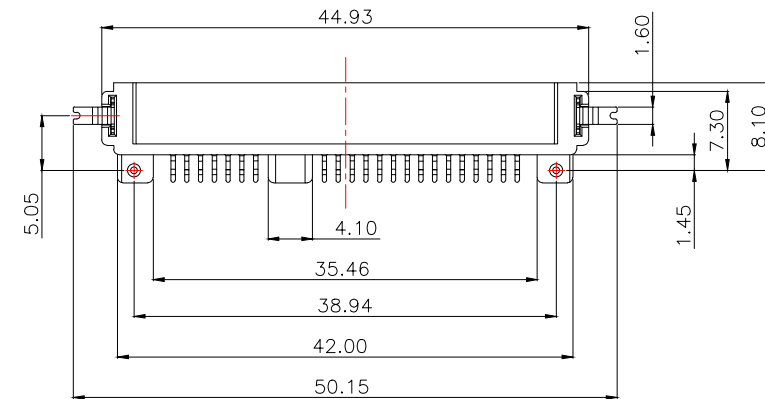
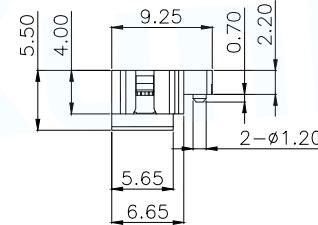
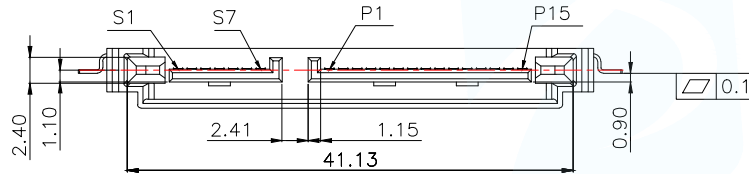

NOTES:

1.MATERIAL:

- 1.1 HOUSING:HIGH TEMPERATURE THERAL PLASTIC, COLOR:SEE TABLE .
- 1.2 CONTACT & LATCH: COPPER ALLOY .

2.FINISH:

- 2.1 CONTACT: (SEE TABLE) GOLD PLATED ON CONTACT AREA, 100m" MIN. MATTE-TIN ON SOLDER TAIL, WITH ENTIRE CONTACT UNDERPLATED 50m" MIN. NICKEL.
- 2.2 LATCH:100m" MIN. TIN OVER 50m"MIN. NICKEL PLATED.

MANUFACTURE DWG		 东莞市讯普电子科技有限公司 DongGuan XunPu Electronics Co.,Ltd		
UNLESS OTHERWISE SPECIFIED TOLERANCES		TITLE: SATA 7+15P 沉板0.9公座		
DECIMALS:			PAR	SATA-020-M22S1BY
ANGLES:			DWN	
X.X±0.30	X.*±5°		CHKD	
X.XX±0.25	X.*±2°		APVD	
X.XXX±0.15	X.XX*±1°	CUSTOMER COPY	SCALE N:A	UNIT:MM
			SIZE:A4	SHEET:1F1
				REV:A

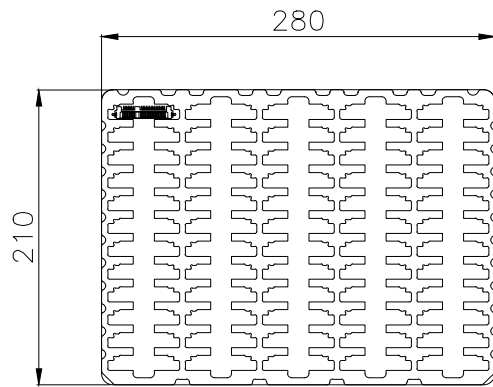

一吸塑盒 = 60PCS

最上层放一个空吸塑盒

每叠 = 20盘

PE膜“工”字型缠绕

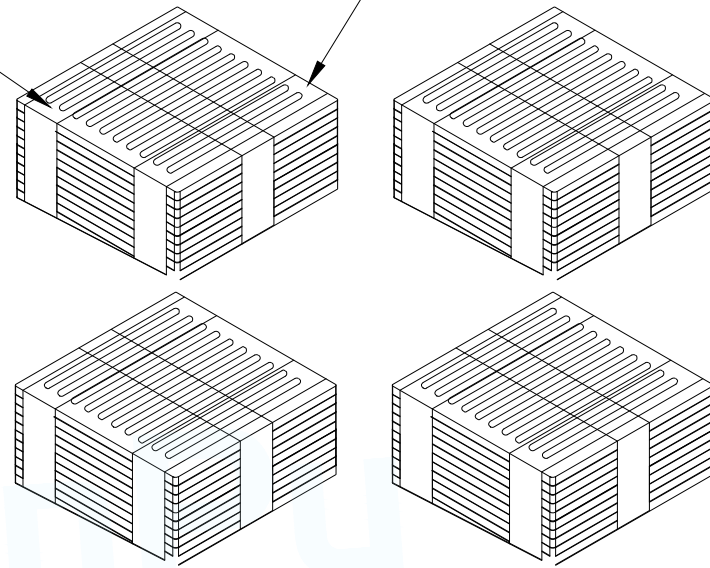

△ 说明:

1. 一叠吸塑盒 = 60 PCS
2. 每叠20盘 = 60 PCS/盘 * 20 = 1200 PCS
3. 一箱 = 4叠 = 每叠1200 PCS * 4 = 4800 PCS/箱

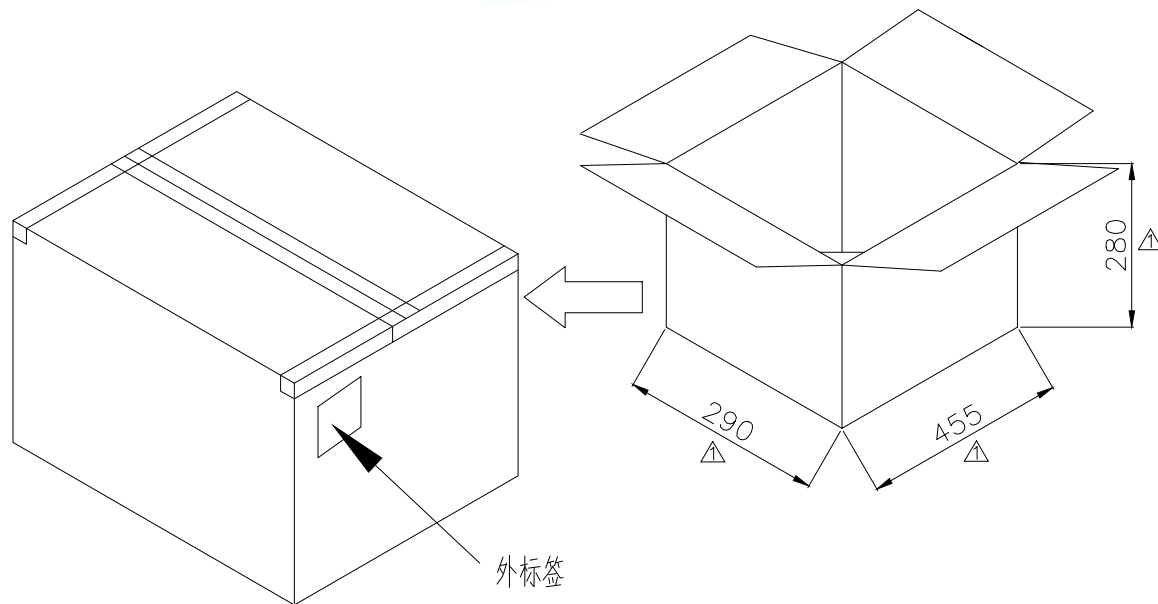

MANUFACTURE DWG		东莞市讯普电子科技有限公司 DongGuan XunPu Electronics Co., Ltd	
UNLESS OTHERWISE SPECIFIED TOLERANCES		TITLE: SATA 7+15P 沉板0.9公差	
		PAR	SATA-020-M22S1BY
		DWN	
		CHKD	
		APVD	
DECIMALS:	ANGLES:	SCALE N:A	UNIT:MM
X.X±0.30	X.*±5°	SIZE:A4	REV:A
X.XX±0.25	X.X*±2°	SHEET:1F1	
X.XXX±0.15	X.XX*±1°		