



DSK12 THRU DSK120

Surface Mount Schottky Rectifiers

Reverse Voltage - 20 to 200 V
Forward Current - 1.0 A

FEATURES

- Metal silicon junction, majority carrier conduction
- For surface mounted applications
- Low power loss, high efficiency
- High forward surge current capability
- For use in low voltage, high frequency inverters, free wheeling, and polarity protection applications

MECHANICAL DATA

- Case: SOD-123FL
- Terminals: Solderable per MIL-STD-750, Method 2026
- Approx. Weight: 15mg 0.00048oz

PINNING

PIN	DESCRIPTION
1	Cathode
2	Anode

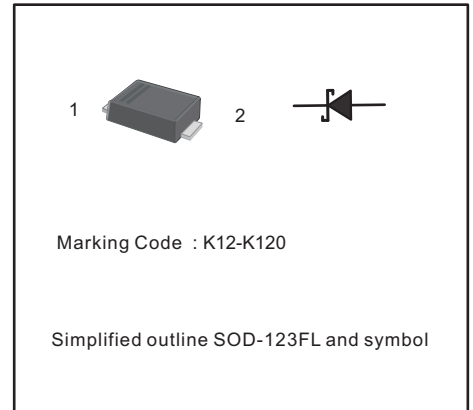

Maximum Ratings and Electrical characteristics

Ratings at 25 °C ambient temperature unless otherwise specified.

Single phase half-wave 60 Hz, resistive or inductive load, for capacitive load current derate by 20 %.

Parameter	Symbols	DSK12	DSK14	DSK16	DSK18	DSK110	DSK112	DSK115	DSK120	Units
Maximum Repetitive Peak Reverse Voltage	V_{RRM}	20	40	60	80	100	120	150	200	V
Maximum RMS voltage	V_{RMS}	14	28	42	56	70	84	105	140	V
Maximum DC Blocking Voltage	V_{DC}	20	40	60	80	100	120	150	200	V
Maximum Average Forward Rectified Current	$I_{F(AV)}$	1.0								A
Peak Forward Surge Current, 8.3ms Single Half Sine-wave Superimposed on Rated Load (JEDEC method)	I_{FSM}	40				30				A
Max Instantaneous Forward Voltage at 1 A	V_F	0.55		0.70		0.85		0.95		V
Maximum DC Reverse Current $T_a = 25^\circ\text{C}$ at Rated DC Reverse Voltage $T_a = 100^\circ\text{C}$	I_R	0.3 10				0.2 5		0.1 2		mA
Typical Junction Capacitance ¹⁾	C_j	110			80					pF
Typical Thermal Resistance ²⁾	$R_{\theta JA}$	115								$^\circ\text{C/W}$
Operating Junction Temperature Range	T_j	-55 ~ +125								$^\circ\text{C}$
Storage Temperature Range	T_{stg}	-55 ~ +150								$^\circ\text{C}$

1) Measured at 1MHz and applied reverse voltage of 4 V D.C.

2) P.C.B. mounted with 0.2 X 0.2" (5 X 5 mm) copper pad areas.



DSK12 THRU DSK120 Surface Mount Schottky Rectifiers

Characteristic Curves ($T = 25^\circ\text{C}$ unless otherwise noted)

Fig.1 Forward Current Derating Curve

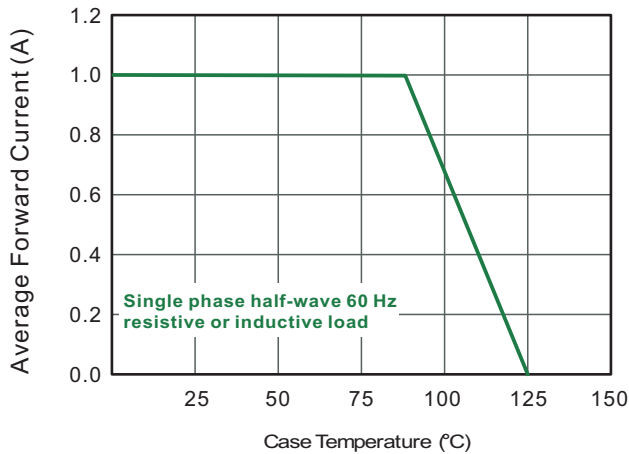

Fig.2 Typical Reverse Characteristics

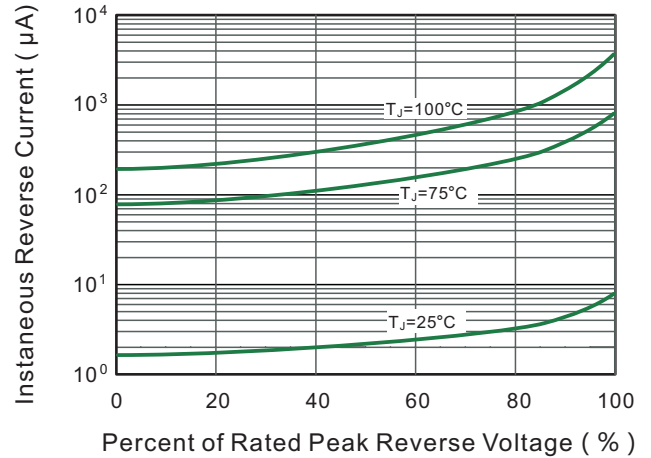

Fig.3 Typical Forward Characteristic

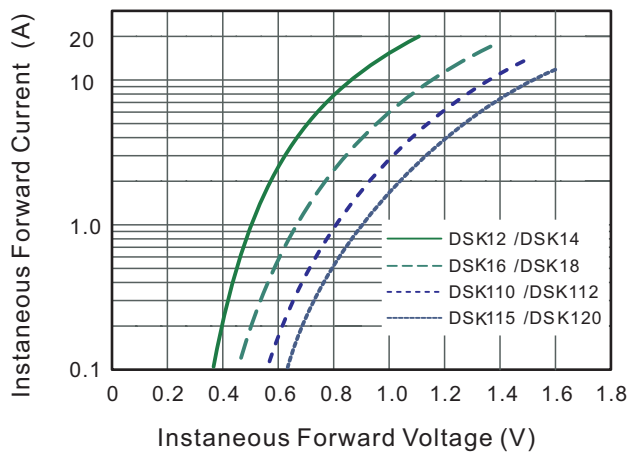

Fig.4 Typical Junction Capacitance

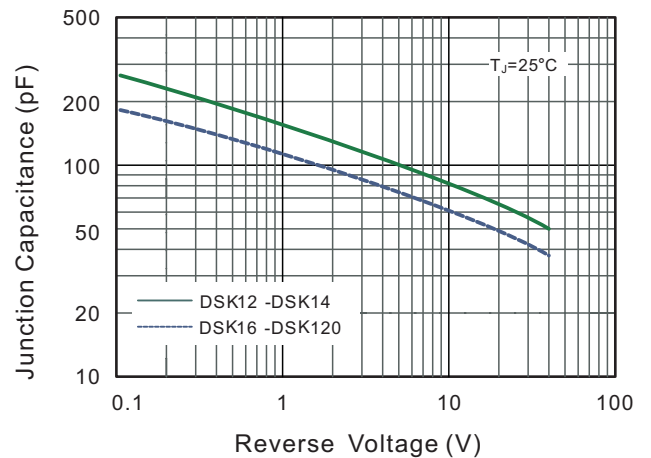

Fig.5 Maximum Non-Repetitive Peak Forward Surge Current

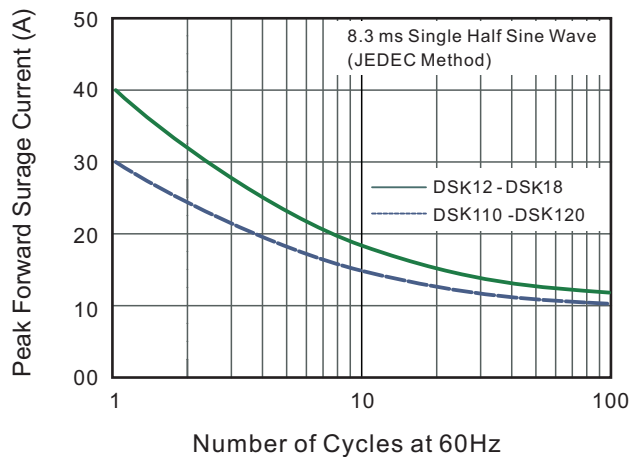
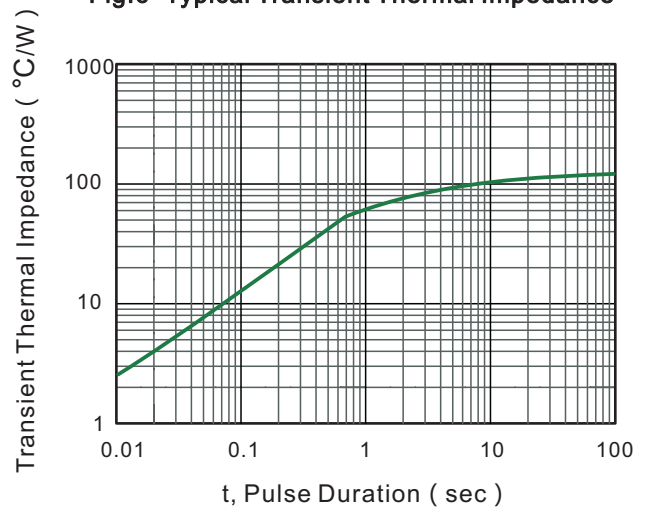

Fig.6- Typical Transient Thermal Impedance





DSK12 THRU DSK120

Surface Mount Schottky Rectifiers

PACKAGE OUTLINE

Plastic surface mounted package; 2 leads

SOD-123FL

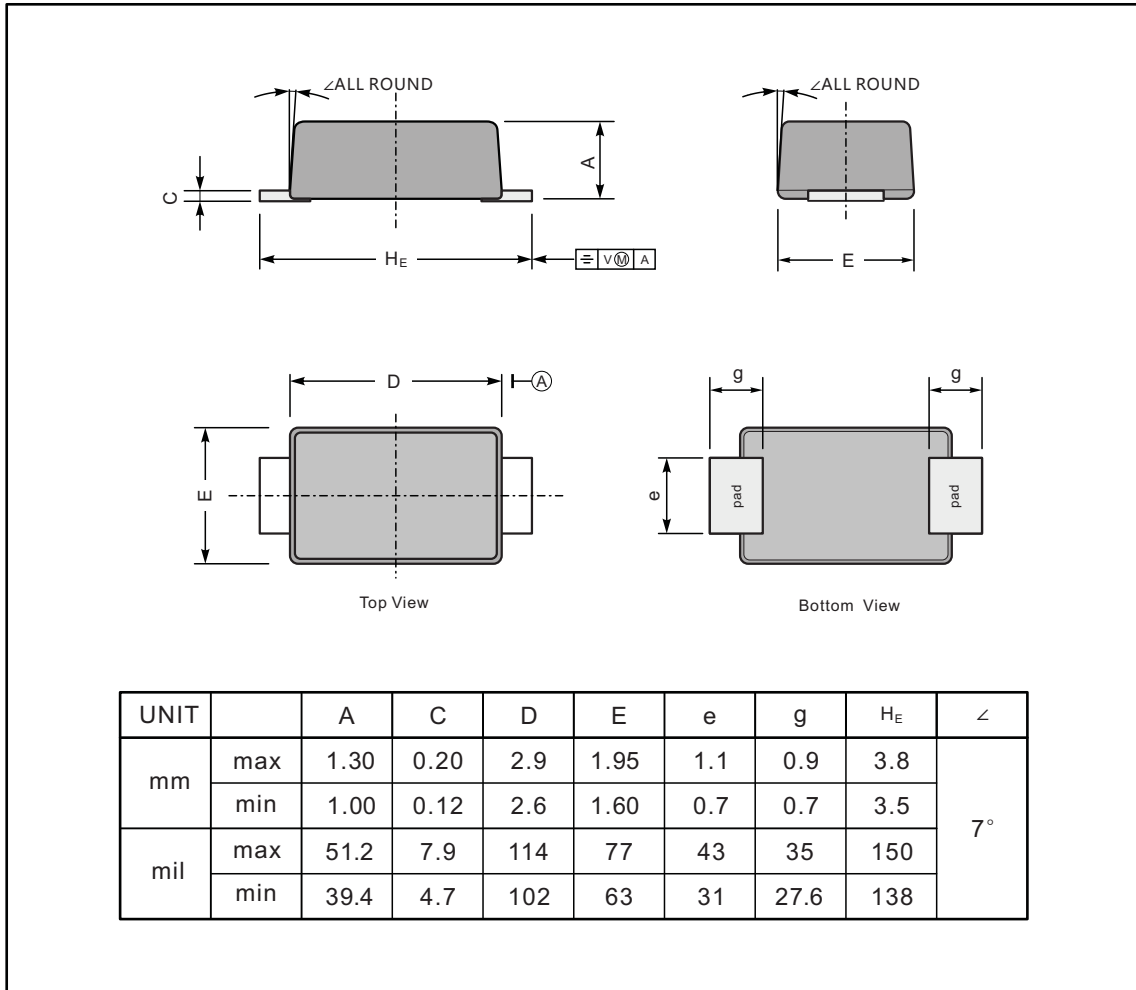

The recommended mounting pad size

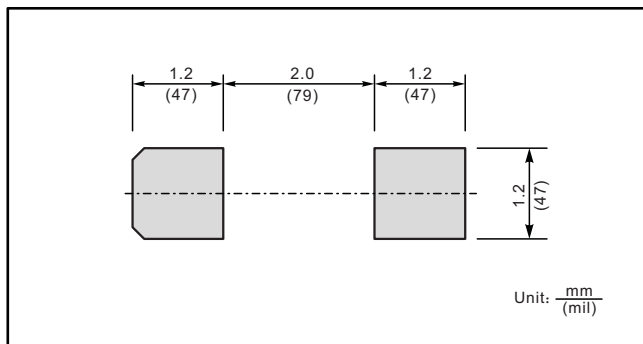

Marking

Type number	Marking code
DSK12	K12
DSK14	K14
DSK16	K16
DSK18	K18
DSK110	K110
DSK112	K112
DSK115	K115
DSK120	K120