



U74LVC1G17

CMOS IC

SINGLE SCHMITT-TRIGGER BUFFER

DESCRIPTION

The UTC **U74LVC1G17** is a single Schmitt-trigger buffer, it provides the function $Y=A$.

The device have different input threshold levels for positive-going (V_{T+}) and negative-going (V_{T-}) signals because of the Schmitt-trigger action in the input.

This device has power-down protective circuit, preventing device destruction when it is powered down.

FEATURES

- * Operation Voltage Range: 1.65V ~ 5.5V
- * Low Power Current: $I_{CC}=10\mu A$ (Max.)
- * $\pm 24mA$ Output Drive ($V_{CC}=3.0V$)
- * Power Down Protection

ORDERING INFORMATION

Ordering Number		Package	Packing
Lead Free	Halogen Free		
U74LVC1G17L-AE5-R	U74LVC1G17G-AE5-R	SOT-23-5	Tape Reel
U74LVC1G17L-AF5-R	U74LVC1G17G-AF5-R	SOT-25	Tape Reel
U74LVC1G17L-AL5-R	U74LVC1G17G-AL5-R	SOT-353	Tape Reel

<p>U74LVC1G17G-AF5-R</p> <p>(1) Packing Type (2) Package Type (3) Green Package</p>	<p>(1) R: Tape Reel (2) AE5: SOT-23-5, AF5: SOT-25, AL5: SOT-353 (3) G: Halogen Free and Lead Free, L: Lead Free</p>
---	--

MARKING

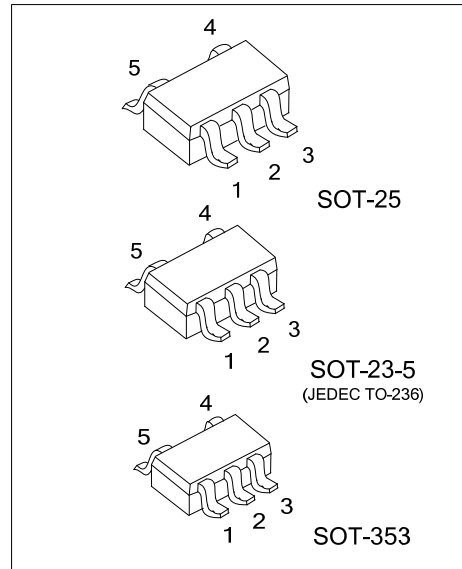
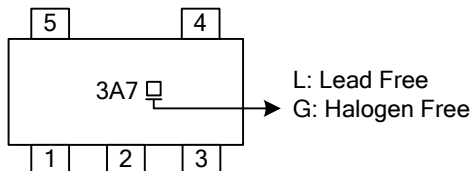

■ PIN CONFIGURATION

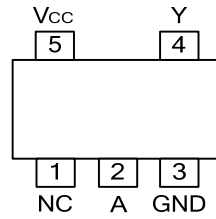

■ FUNCTION TABLE (each gate)

INPUT	OUTPUT
A	Y
L	L
H	H

■ LOGIC DIAGRAM (positive logic)

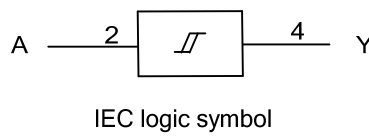
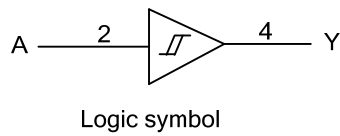

■ ABSOLUTE MAXIMUM RATING (T_A=25°C, unless otherwise specified) (Note 2)

PARAMETER	SYMBOL	TEST CONDITIONS	RATINGS	UNIT
Supply Voltage	V _{CC}		-0.5 ~ 6.5	V
Input Voltage	V _{IN}		-0.5 ~ 6.5	V
Output Voltage	V _{OUT}	Output in the high or low state	-0.5 ~ V _{CC} +0.5	V
		Output in the power-off state	-0.5 ~ 6.5	V
Continuous V _{CC} or GND Current	I _{CC}		±100	mA
Continuous Output Current	I _{OUT}		±50	mA
Input Clamp Current	I _{IK}	V _{IN} <0	-50	mA
Output Clamp Current	I _{OK}	V _{OUT} <0	-50	mA
Junction Temperature	T _J		+150	°C
Storage Temperature Range	T _{STG}		-65 ~ +150	°C

Notes: 1. Absolute maximum ratings are those values beyond which the device could be permanently damaged. Absolute maximum ratings are stress ratings only and functional device operation is not implied.
 2. The input and output voltage ratings may be exceeded if the input and output current ratings are observed.

■ THERMAL DATA

PARAMETER	SYMBOL	RATINGS	UNIT
Junction to Ambient	SOT-23-5	280	°C/W
	SOT-25	230	°C/W
	SOT-353	350	°C/W
Junction to Case	SOT-23-5	100	°C/W
	SOT-25	90	°C/W
	SOT-353	120	°C/W

■ RECOMMENDED OPERATING CONDITIONS

PARAMETER	SYMBOL	TEST CONDITIONS	MIN	TYP	MAX	UNIT
Supply Voltage	V _{CC}	Operating	1.65		5.5	V
		Data retention only	1.5			V
Input Voltage	V _{IN}		0		5.5	V
Output Voltage	V _{OUT}	High or low state	0		V _{CC}	V
Operating Temperature	T _A		-40		+125	°C

■ STATIC CHARACTERISTICS

PARAMETER	SYMBOL	TEST CONDITIONS	MIN	TYP	MAX	UNIT
Positive-going Input Threshold Voltage	V _{T+}	V _{CC} =1.65V	0.76		1.16	V
		V _{CC} =2.3V	1.08		1.56	
		V _{CC} =3.0V	1.48		1.92	
		V _{CC} =4.5V	2.16		2.74	
		V _{CC} =5.5V	2.61		3.33	
Negative-going Input Threshold Voltage	V _{T-}	V _{CC} =1.65V	0.35		0.62	V
		V _{CC} =2.3V	0.56		0.88	
		V _{CC} =3.0V	0.84		1.2	
		V _{CC} =4.5V	1.41		1.97	
		V _{CC} =5.5V	1.87		2.4	
Hysteresis Voltage (V _{T+} -V _{T-})	ΔV _T	V _{CC} =1.65V	0.36		0.64	V
		V _{CC} =2.3V	0.45		0.78	
		V _{CC} =3.0V	0.51		0.87	
		V _{CC} =4.5V	0.58		1.04	
		V _{CC} =5.5V	0.69		1.11	

■ STATIC CHARACTERISTICS (Cont.)

PARAMETER	SYMBOL	TEST CONDITIONS	MIN	TYP	MAX	UNIT	
High-Level Output Voltage	V_{OH}	$V_{CC}=1.65V\sim 5.5V, I_{OH}=-100\mu A$	$V_{CC}-0.1$			V	
		$V_{CC}=1.65V, I_{OH}=-4mA$	1.2				
		$V_{CC}=2.3V, I_{OH}=-8mA$	1.9				
		$V_{CC}=3.0V$	$I_{OH}=-16mA$	2.4			
			$I_{OH}=-24mA$	2.3			
		$V_{CC}=4.5V, I_{OH}=-32mA$	3.8				
Low-Level Output Voltage	V_{OL}	$V_{CC}=1.65V\sim 5.5V, I_{OL}=100\mu A$			0.1	V	
		$V_{CC}=1.65V, I_{OL}=4mA$			0.45		
		$V_{CC}=2.3V, I_{OL}=8mA$			0.3		
		$V_{CC}=3.0V$	$I_{OL}=16mA$				0.4
			$I_{OL}=24mA$				0.55
		$V_{CC}=4.5V, I_{OL}=32mA$			0.55		
Input Leakage Current	$I_{I(LEAK)}$	$V_{CC}=0\sim 5.5V, V_{IN}=V_{CC}$ or GND			± 5	μA	
Power OFF Leakage Current	I_{OFF}	$V_{CC}=0V, V_{IN}$ or $V_{OUT}=5.5V$			± 10	μA	
Quiescent Supply Current	I_Q	$V_{CC}=1.65V\sim 5.5V, V_{IN}=V_{CC}$ or GND $I_{OUT}=0$			10	μA	
Additional Quiescent Supply Current	ΔI_Q	$V_{CC}=3V\sim 5.5V$, One input at $V_{CC}-0.6V$, other inputs at V_{CC} or GND			500	μA	
Input Capacitance	C_{IN}	$V_{CC}=3.3V, V_{IN}=V_{CC}$ or GND		4.5		pF	

■ DYNAMIC CHARACTERISTICS

PARAMETER	SYMBOL	TEST CONDITIONS	MIN	TYP	MAX	UNIT	
Propagation delay from input (A) to output (Y)	t_{PLH} / t_{PHL}	$C_L=15pF$	$V_{CC}=1.8\pm 0.15V$	2.8		13	ns
			$V_{CC}=2.5\pm 0.2V$	1.6		9.1	ns
			$V_{CC}=3.3\pm 0.3V$	1.5		8.2	ns
			$V_{CC}=5\pm 0.5V$	0.9		6.8	ns
		$C_L=30$ or $50pF$	$V_{CC}=1.8\pm 0.15V$	3.8		14.5	ns
			$V_{CC}=2.5\pm 0.2V$	2		11.1	ns
			$V_{CC}=3.3\pm 0.3V$	1.8		10.2	ns
			$V_{CC}=5\pm 0.5V$	1.2		8.3	ns

■ OPERATING CHARACTERISTICS (f=10MHz, $T_A=25^\circ C$, unless otherwise specified)

PARAMETER	SYMBOL	TEST CONDITIONS	MIN	TYP	MAX	UNIT
Power Dissipation Capacitance	C_{PD}	$V_{CC}=1.8V$		20		pF
		$V_{CC}=2.5V$		21		pF
		$V_{CC}=3.3V$		22		pF
		$V_{CC}=5V$		25		pF

■ TEST CIRCUIT AND WAVEFORMS

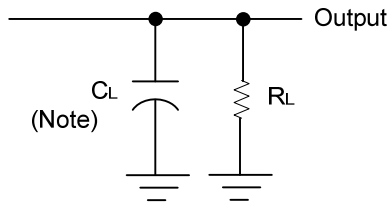

Note: C_L includes probe and jig capacitance.

V_{CC}	V_{IN}	t_R, t_F	V_M	C_L	R_L
1.8V±0.15V	V_{CC}	≤2ns	$V_{CC}/2$	15pF	1MΩ
2.5V±0.2V	V_{CC}	≤2ns	$V_{CC}/2$	15pF	1MΩ
3.3V±0.3V	3V	≤2.5ns	1.5V	15pF	1MΩ
5V±0.5V	V_{CC}	≤2.5ns	$V_{CC}/2$	15pF	1MΩ
1.8V±0.15V	V_{CC}	≤2ns	$V_{CC}/2$	30pF	1KΩ
2.5V±0.2V	V_{CC}	≤2ns	$V_{CC}/2$	30pF	500Ω
3.3V±0.3V	3V	≤2.5ns	1.5V	50pF	500Ω
5V±0.5V	V_{CC}	≤2.5ns	$V_{CC}/2$	50pF	500Ω

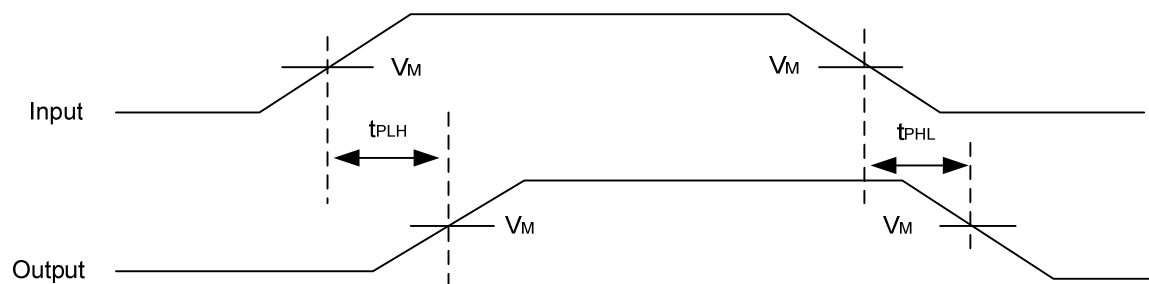

UTC assumes no responsibility for equipment failures that result from using products at values that exceed, even momentarily, rated values (such as maximum ratings, operating condition ranges, or other parameters) listed in products specifications of any and all UTC products described or contained herein. UTC products are not designed for use in life support appliances, devices or systems where malfunction of these products can be reasonably expected to result in personal injury. Reproduction in whole or in part is prohibited without the prior written consent of the copyright owner. UTC reserves the right to make changes to information published in this document, including without limitation specifications and product descriptions, at any time and without notice. This document supersedes and replaces all information supplied prior to the publication hereof.