

Description:

This P-Channel MOSFET uses advanced trench technology and design to provide excellent $R_{DS(on)}$ with low gate charge.

It can be used in a wide variety of applications.

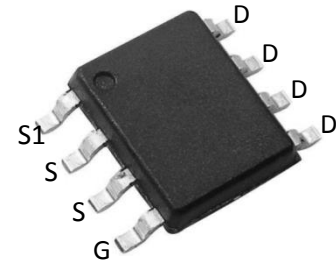

Features:

- 1) $V_{DS}=-30V, I_D=-10A, R_{DS(ON)}<20m\ \Omega @V_{GS}=-10V$
- 2) Low gate charge.
- 3) Green device available.
- 4) Advanced high cell density trench technology for ultra $R_{DS(ON)}$.
- 5) Excellent package for good heat dissipation.

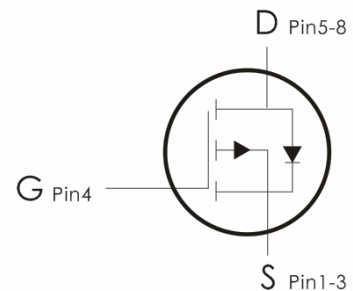

Absolute Maximum Ratings: ($T_C=25^\circ C$ unless otherwise noted)

Symbol	Parameter	Ratings	Units
V_{DS}	Drain-Source Voltage	-30	V
V_{GS}	Gate-Source Voltage	± 20	V
I_D	Continuous Drain Current- $T_C=25^\circ C$	-10	A
	Continuous Drain Current- $T_C=100^\circ C$	-5.1	
	Pulsed Drain Current ¹	-32	
E_{AS}	Single Pulse Avalanche Energy	---	mJ
P_D	Power Dissipation($T_C=25^\circ C$)	2.1	W
T_J, T_{STG}	Operating and Storage Junction Temperature Range	-55 to +150	$^\circ C$

Thermal Characteristics:

Symbol	Parameter	Max	Units
$R_{\theta JC}$	Thermal Resistance, Junction to Case	---	$^\circ C/W$
$R_{\theta JA}$	Thermal Resistance, Junction to Ambient	60	

Electrical Characteristics: ($T_C=25^\circ\text{C}$ unless otherwise noted)

Symbol	Parameter	Conditions	Min	Typ	Max	Units
Off Characteristics						
BV_{DSS}	Drain-Source Breakdown Voltage	$V_{GS}=0V, I_D=-250\ \mu\text{A}$	-30	---	---	V
I_{DSS}	Zero Gate Voltage Drain Current	$V_{DS}=-30V, V_{GS}=0V, T_J=25^\circ\text{C}$	---	---	-1	μA
I_{GSS}	Gate-Source Leakage Current	$V_{GS}=\pm 20V, V_{DS}=0V$	---	---	± 100	nA
On Characteristics						
$V_{GS(th)}$	GATE-Source Threshold Voltage	$V_{GS}=V_{DS}, I_D=-250\ \mu\text{A}$	-1.0	-1.6	-2.5	V
$R_{DS(on)}$	Drain-Source On Resistance ²	$V_{GS}=-10V, I_D=-8A$	---	16.5	20	m Ω
		$V_{GS}=-4.5V, I_D=-5A$	---	25.6	32	
G_{FS}	Forward Transconductance	$V_{DS}=-10V, I_D=-3A$	---	6.8	---	S
Dynamic Characteristics						
C_{iss}	Input Capacitance	$V_{DS}=-15V, V_{GS}=0V, f=1\text{MHz}$	---	1250	1820	pF
C_{oss}	Output Capacitance		---	160	235	
C_{rss}	Reverse Transfer Capacitance		---	90	130	
Switching Characteristics						
$t_{d(on)}$	Turn-On Delay Time ^{2,3}	$V_{DD}=-15V, V_{GS}=-10V, R_G=6\Omega, I_D=-1A$	---	5.8	11	ns
t_r	Rise Time ^{2,3}		---	18.8	36	ns
$t_{d(off)}$	Turn-Off Delay Time ^{2,3}		---	46.9	89	ns
t_f	Fall Time ^{2,3}		---	12.3	23	ns
Q_g	Total Gate Charge ^{2,3}	$V_{DS}=-15V, V_{GS}=-4.5V, I_D=-5A$	---	11	17	nC
Q_{gs}	Gate-Source Charge ^{2,3}		---	3.4	6	nC
Q_{gd}	Gate-Drain "Miller" Charge ^{2,3}		---	4.2	8	nC
Drain-Source Diode Characteristics						
V_{SD}	Source-Drain Diode Forward Voltage ²	$V_{GS}=0V, I_S=-1A$	---	---	-1	V

Notes:

1. Repetitive Rating : Pulsed width limited by maximum junction temperature.
2. The data tested by pulsed , pulse width \cong 300us , duty cycle \cong 2%.
3. Essentially independent of operating temperature.

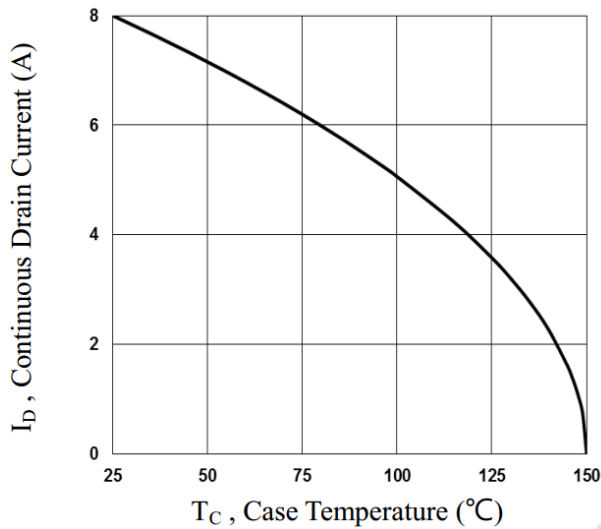
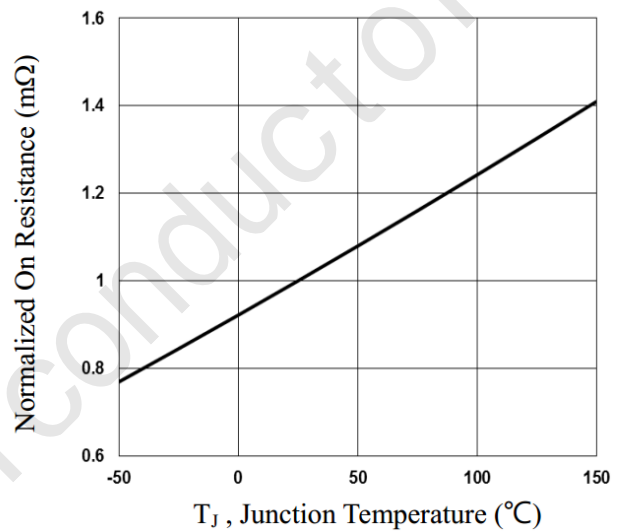
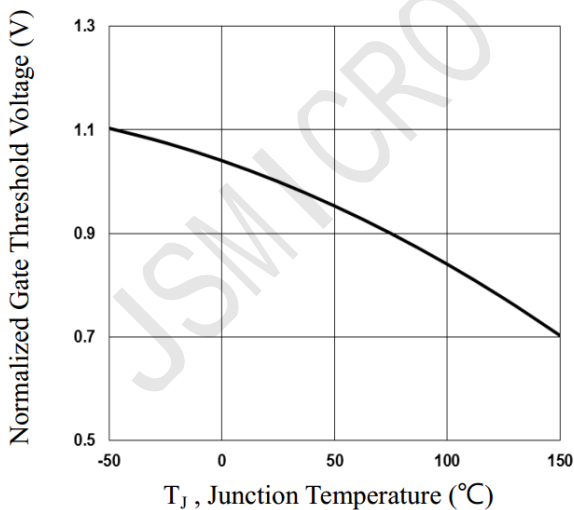
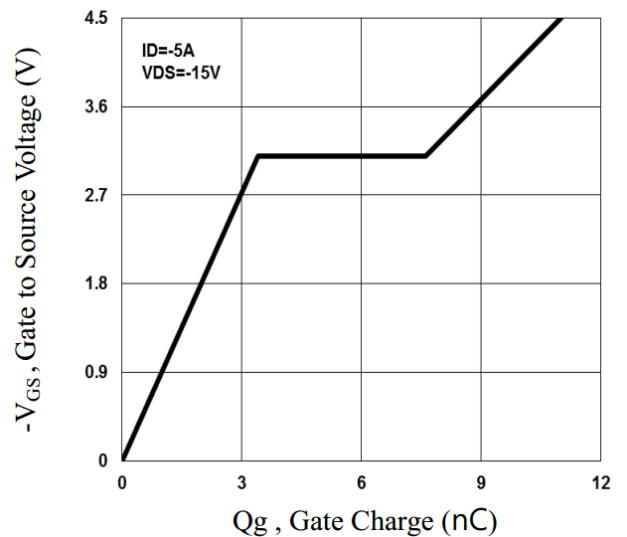
Typical Characteristics: ($T_c=25^\circ\text{C}$ unless otherwise noted)

Fig.1 Continuous Drain Current vs. T_c

Fig.2 Normalized $R_{DS(on)}$ vs. T_j

Fig.3 Normalized V_{th} vs. T_j

Fig.4 Gate Charge Waveform

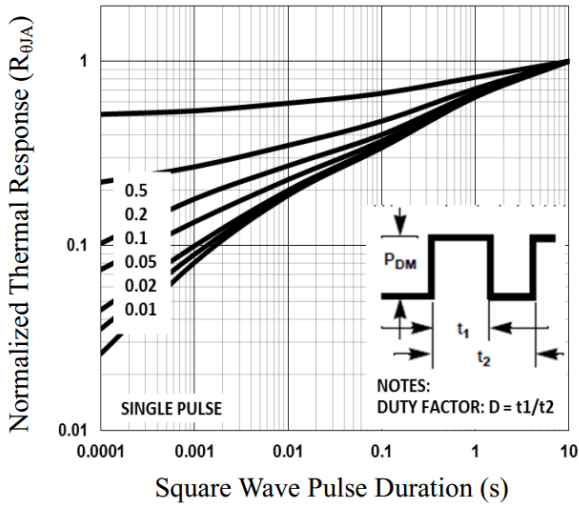

Fig.5 Normalized Transient Impedance

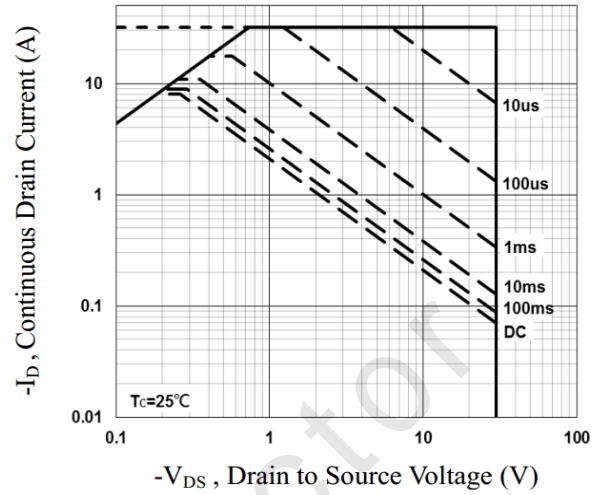

Fig.6 Maximum Safe Operation Area

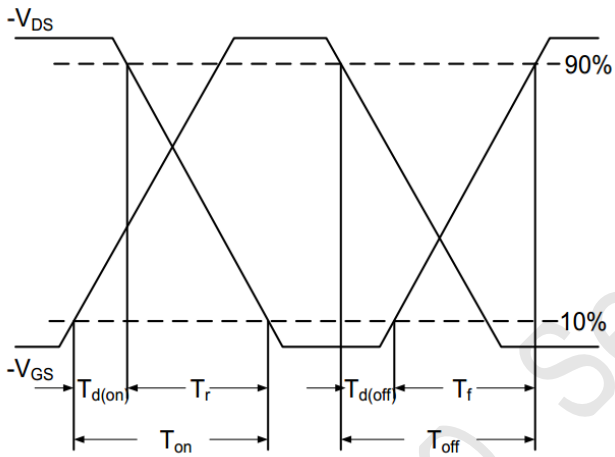

Fig.7 Switching Time Waveform

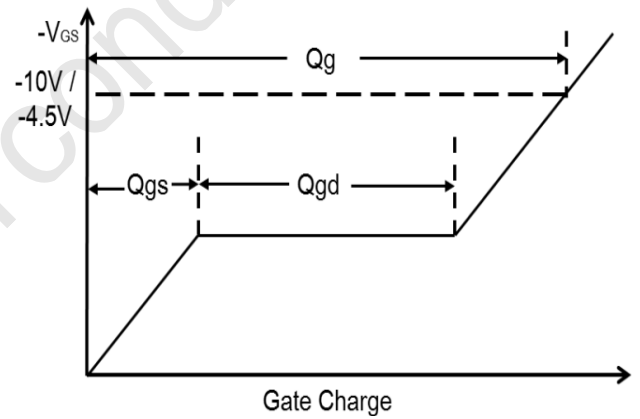
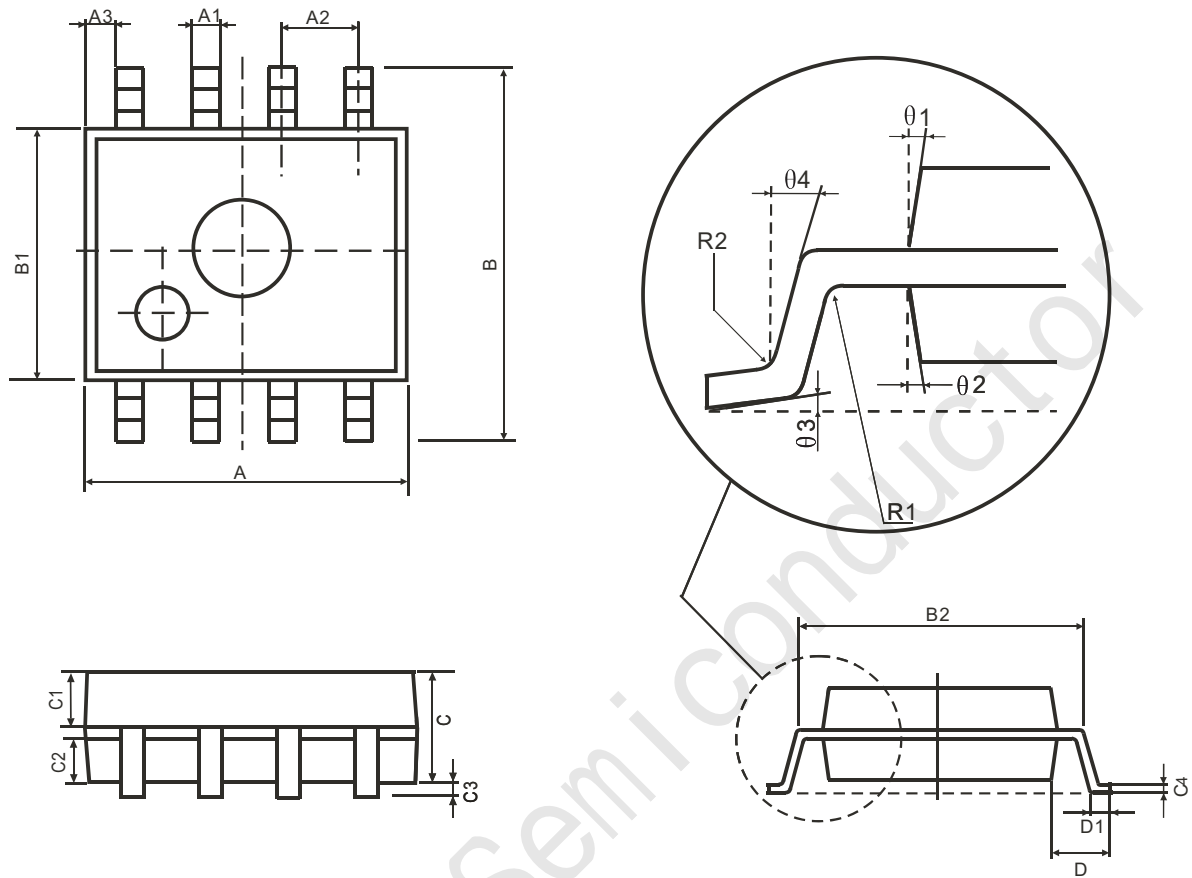

Fig.8 Gate Charge Waveform

封装尺寸
SOP8

符号	尺寸(mm)		符号	尺寸(mm)	
	最小值	最大值		最小值	最大值
A	4.95	5.15	C3	0.05	0.20
A1	0.37	0.47	C4	0.20(典型值)	
A2	1.27(典型值)		D	1.05(典型值)	
A3	0.41(典型值)		D1	0.40	0.60
B	5.80	6.20	R1	0.07(典型值)	
B1	3.80	4.00	R2	0.07(典型值)	
B2	5.0(典型值)		θ1	17°(典型值)	
C	1.30	1.50	θ2	13°(典型值)	
C1	0.55	0.65	θ3	4°(典型值)	
C2	0.55	0.65	θ4	12°(典型值)	