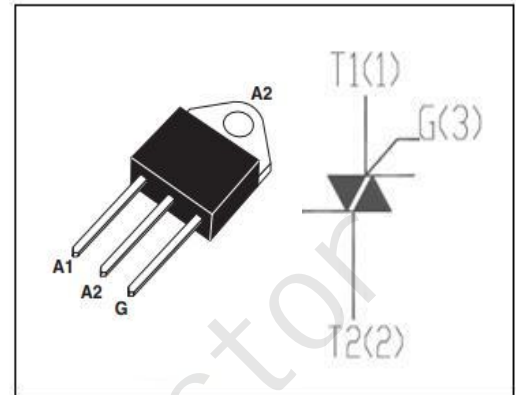

DESCRIPTION

- With TO-3P packaging
- Operating in 4 quadrants
- High commutation capability
- Minimum Lot-to-Lot variations for robust device performance and reliable operation

APPLICATIONS

- Solid state relays; heating and cooking appliances
- Switching applications

ABSOLUTE MAXIMUM RATINGS (T_a=25°C)

SYMBOL	PARAMETER		MAX	UNIT
V _{DRM}	Repetitive peak off-state voltage		800	V
V _{RRM}	Repetitive peak reverse voltage		800	V
I _{T(RSM)}	Average on-state current @T _c =80°C		40	A
I _{TSM}	Surge non-repetitive on-state current	50HZ 60HZ	400 420	A
P _{G(AV)}	Average gate power dissipation (over any 20 ms period)		1.0	W
T _j	Operating junction temperature		-40~125	°C
T _{stg}	Storage temperature		-40~150	°C

ELECTRICAL CHARACTERISTICS (T_c=25°C unless otherwise specified)

SYMBOL	PARAMETER	CONDITIONS		MIN	MAX	UNIT
I _{RRM}	Repetitive peak reverse current	V _R =V _{RRM} Rated; V _D =V _{DRM} Rated;	T _j =25°C		0.005	mA
I _{DRM}	Repetitive peak off-state current		T _j =125°C			
V _{TM}	On-state voltage	I _T =60A			1.55	V
I _{GT}	Gate-trigger current	V _D = 12V; RG=33 Ω		I	50	mA
				II	50	
				III	50	
				IV	100	
V _{GT}	Gate-trigger voltage	V _D = 12V; RG=33 Ω			1.3	V
R _{th(j-c)}	Junction to case	Half cycle			0.9	°C/W

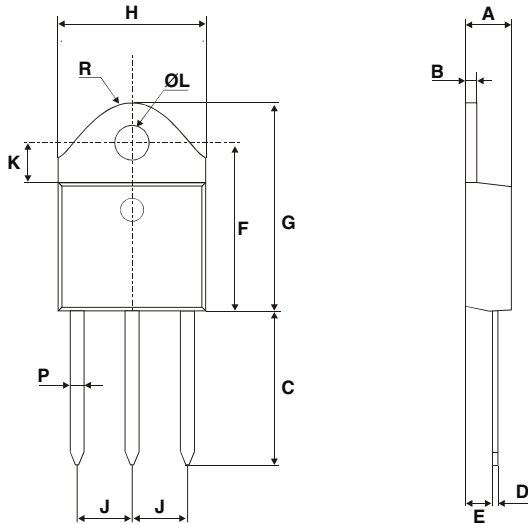
TO-3P (Insulated and non insulated) Package Mechanical Data

REF.	DIMENSIONS					
	Millimeters			Inches		
	Min.	Typ.	Max.	Min.	Typ.	Max.
A	4.4		4.6	0.173		0.181
B	1.45		1.55	0.057		0.061
C	14.35		15.60	0.565		0.614
D	0.5		0.7	0.020		0.028
E	2.7		2.9	0.106		0.114
F	15.8		16.5	0.622		0.650
G	20.4		21.1	0.815		0.831
H	15.1		15.5	0.594		0.610
J	5.4		5.65	0.213		0.222
K	3.4		3.65	0.134		0.144
ØL	4.08		4.17	0.161		0.164
P	1.20		1.40	0.047		0.055
R		4.60			0.181	