

100V N-Channel Power MOSFET

DESCRIPTION

The MDT60N10D uses advanced trench technology to provide excellent $R_{DS(ON)}$, low gate charge. It can be used in a wide variety of applications.

Application

- Power switching application
- Hard switched and High frequency circuits
- Uninterruptible power supply

KEY CHARACTERISTICS

- $V_{DS} = 100V, I_D = 60A$
- $R_{DS(ON)} < 16.5m\Omega @ V_{GS}=10V$
- Special process technology for high ESD capability
- High density cell design for lower R_{dson}
- Fully characterized avalanche voltage and current
- Good stability and uniformity with high EAS
- Excellent package for good heat dissipation

100% UIS TESTED!

100% DVDS TESTED!



TO-220 Top View

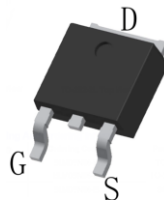

TO-252-2L Top View

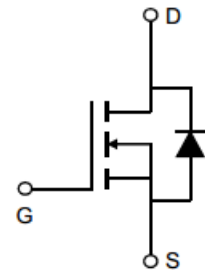

Schematic diagram

Package Marking And Ordering Information

Device Marking	Ordering Codes	Package	Product Code	Packing
M60N10	MPG60N10-P	TO-220	MPG60N10	Tube
M60N10	MDT60N10-D	TO-252-2L	MDT60N10	Tape Reel

Absolute Maximum Ratings ($T_A=25^\circ C$ unless otherwise noted)

Parameter	Symbol	Limit	Unit
Drain-Source Voltage	V_{DS}	100	V
Gate-Source Voltage	V_{GS}	± 20	V
Drain Current-Continuous	I_D	60	A
Drain Current-Pulsed (Note 1)	I_{DM}	240	A
Maximum Power Dissipation($T_c=25^\circ C$)	P_D	160	W
Single pulse avalanche energy (Note 2)	E_{AS}	250	mJ
Operating Junction and Storage Temperature Range	T_J, T_{STG}	-55 To 175	$^\circ C$

Thermal Characteristic

Thermal Resistance, Junction-to-Case	$R_{\theta JC}$	0.93	$^\circ C/W$
--------------------------------------	-----------------	------	--------------

Electrical Characteristics (TA=25°C unless otherwise noted)

Parameter	Symbol	Condition	Min	Typ	Max	Unit
Off Characteristics						
Drain-Source Breakdown Voltage	BV_{DSS}	$V_{GS}=0V, I_D=250\mu A$	100	-	-	V
Zero Gate Voltage Drain Current	I_{DSS}	$V_{DS}=100V, V_{GS}=0V$	-	-	1	μA
Gate-Body Leakage Current	I_{GSS}	$V_{GS}=\pm 20V, V_{DS}=0V$	-	-	± 100	nA
On Characteristics						
Gate Threshold Voltage	$V_{GS(th)}$	$V_{DS}=V_{GS}, I_D=250\mu A$	2	3	4	V
Drain-Source On-State Resistance ^(Note 3)	$R_{DS(ON)}$	$V_{GS}=10V, I_D=30A$	-	14.5	16.5	m Ω
Dynamic Characteristics						
Input Capacitance	C_{iss}	$V_{DS}=25V, V_{GS}=0V,$ $f=1.0MHz$	-	3720	-	pF
Output Capacitance	C_{oss}		-	225	-	pF
Reverse Transfer Capacitance	C_{riss}		-	183	-	pF
Switching Characteristics ^(Note 4)						
Turn-on Delay Time	$t_{d(on)}$	$V_{DD}=50V, I_D=30A,$ $V_{GS}=10V, R_{GEN}=3\Omega$	-	12	-	nS
Turn-on Rise Time	t_r		-	9	-	nS
Turn-Off Delay Time	$t_{d(off)}$		-	20	-	nS
Turn-Off Fall Time	t_f		-	18	-	nS
Total Gate Charge	Q_g	$V_{DS}=80V, I_D=30A$ $V_{GS}=10V$	-	80	-	nC
Gate-Source Charge	Q_{gs}		-	23	-	nC
Gate-Drain Charge	Q_{gd}		-	26	-	nC
Drain-Source Diode Characteristics						
Diode Forward Voltage	V_{SD}	$V_{GS}=0V, I_S=60A$	-	-	1.2	V

Notes:

1. Repetitive Rating: Pulse width limited by maximum junction temperature.
2. EAS condition : $T_j=25^\circ C, V_{DD}=50V, V_G=10V, L=0.5mH, R_g=25\Omega$
3. Pulse Test: Pulse Width $\leq 300\mu s$, Duty Cycle $\leq 2\%$.
4. Guaranteed by design, not subject to production.

Characteristics Curves

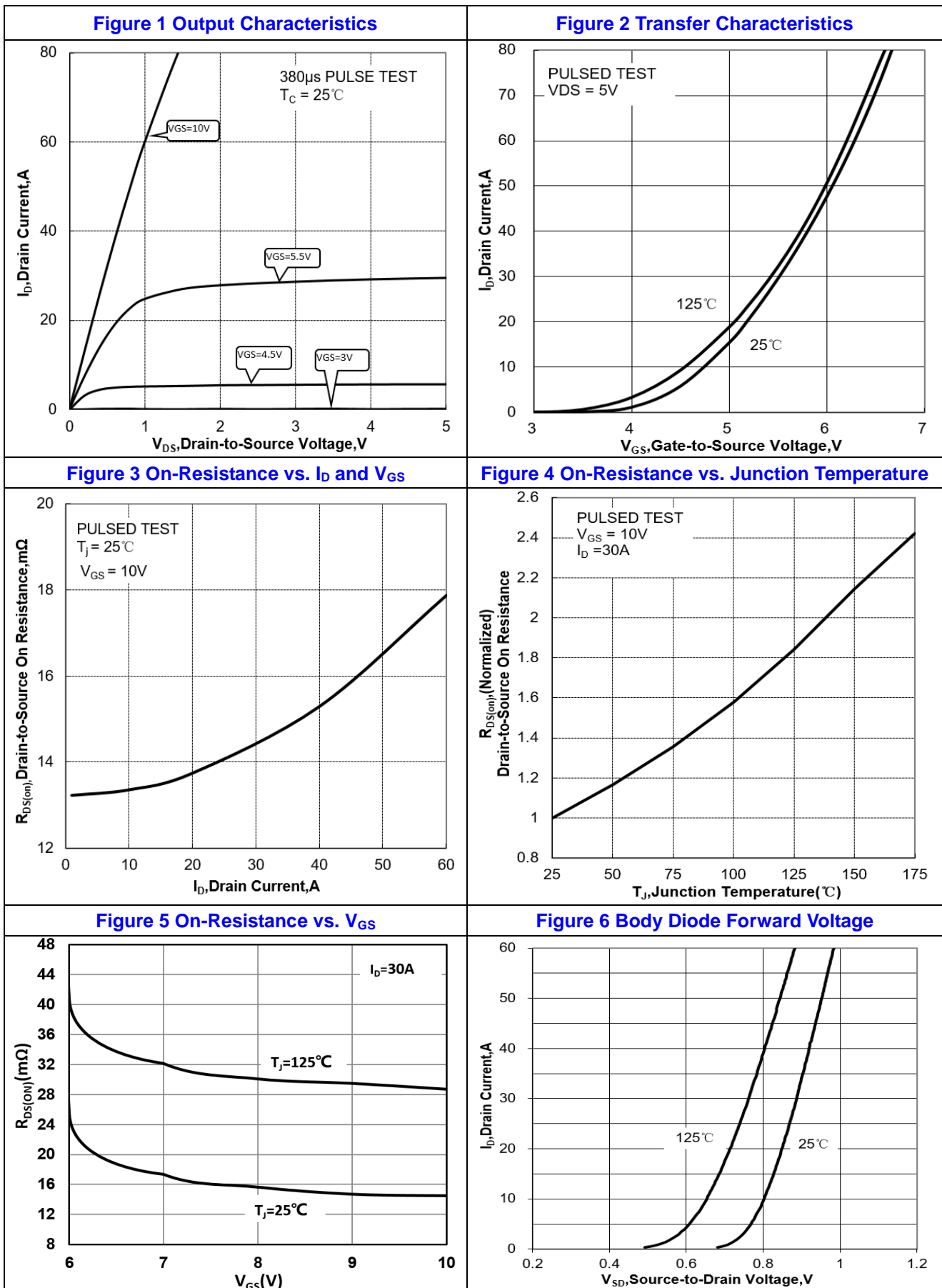

Figure 7 Gate-Charge Characteristics

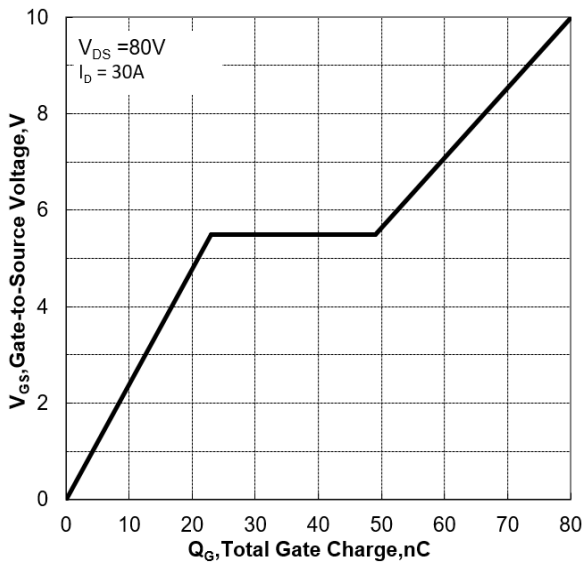

Figure 8 Capacitance Characteristics

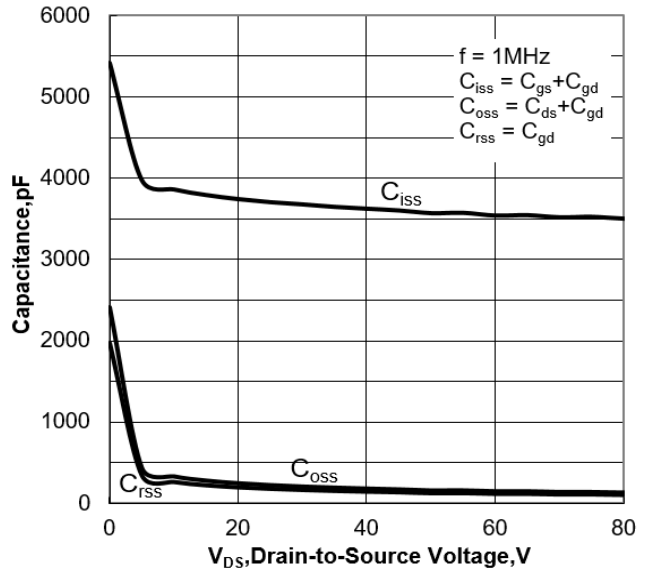

Figure 9 Maximum Forward Biased Safe Operation Area

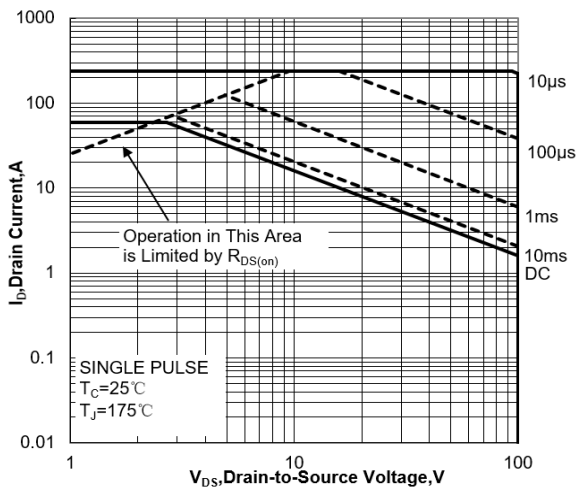

Figure 10 Single Pulse Power Rating Junction-to-Ambient

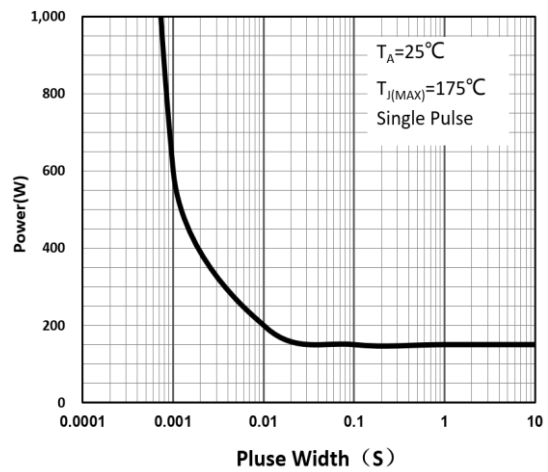
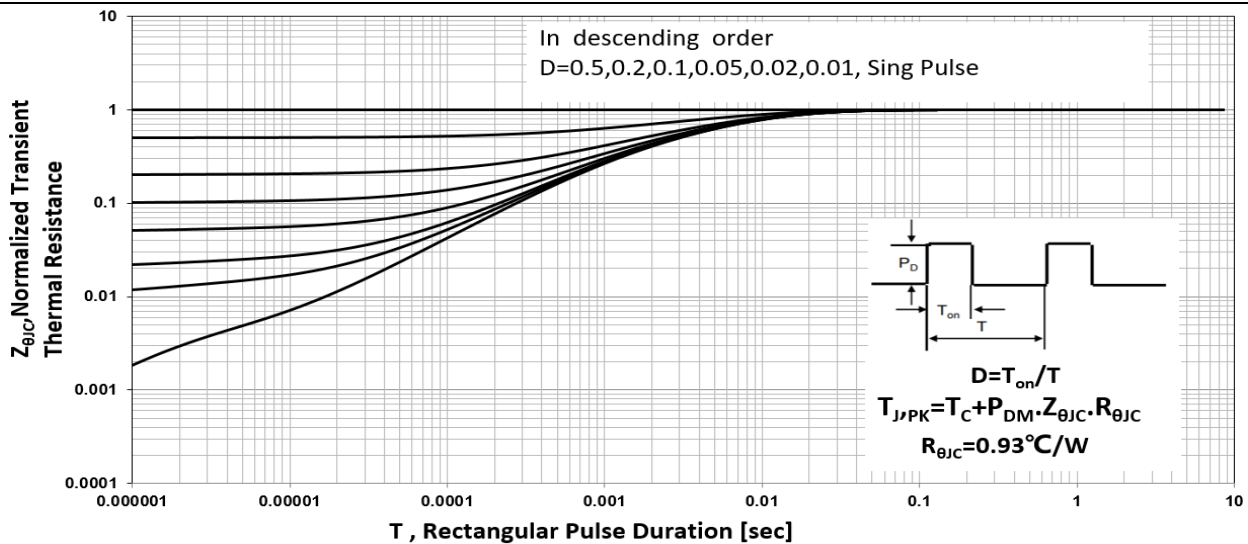
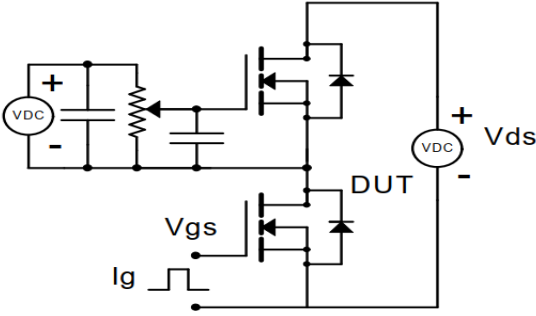
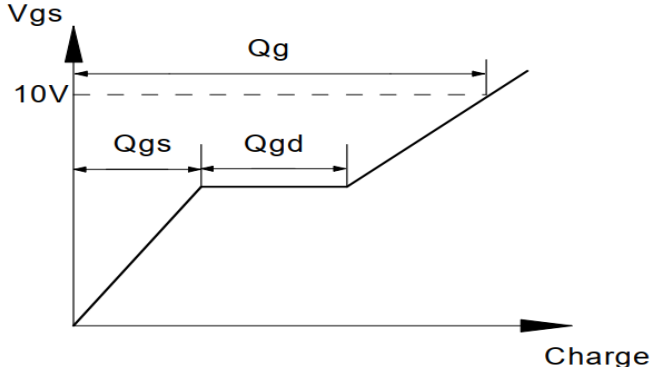
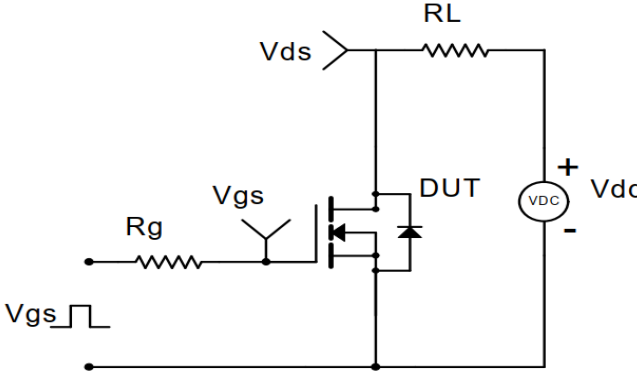
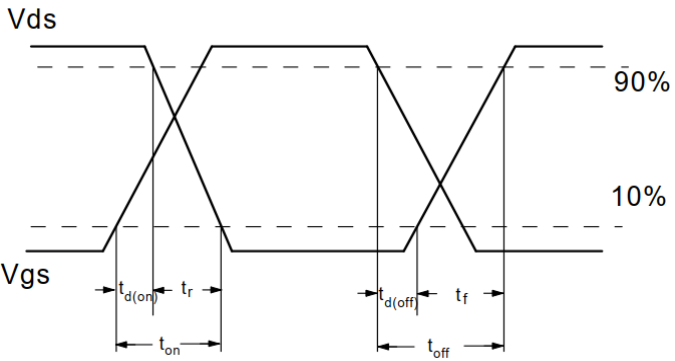
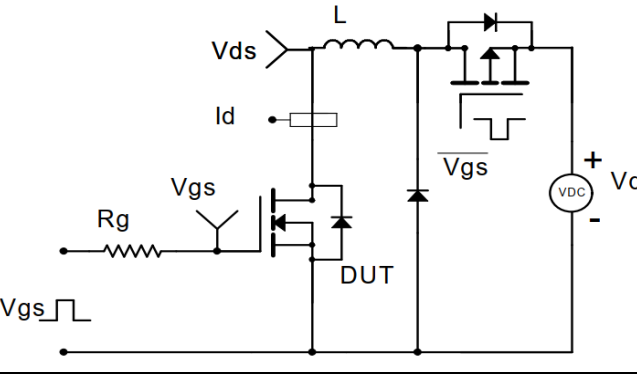
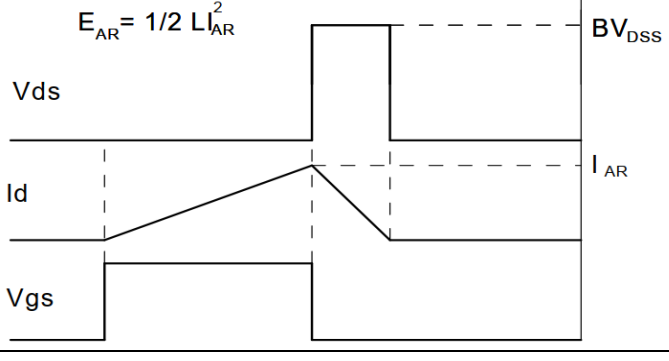
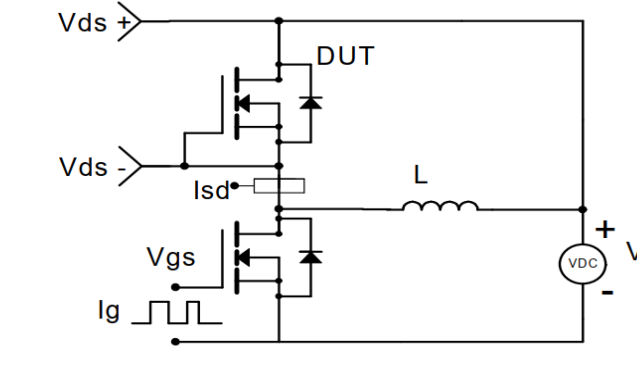
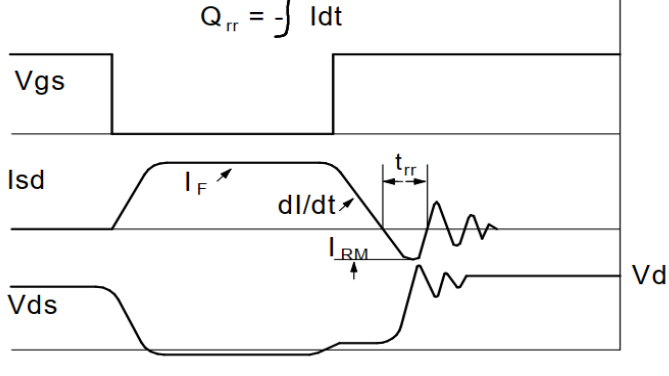

Figure 11 Normalized Maximum Transient Thermal Impedance



Test Circuit and Waveform

<p style="text-align: center;">Gate Charge Test Circuit</p> 	<p style="text-align: center;">Gate Charge Test Waveform</p> 
<p style="text-align: center;">Resistive Switching Test Circuit</p> 	<p style="text-align: center;">Resistive Switching Test Waveforms</p> 
<p style="text-align: center;">Unclamped Inductive Switching (UIS) Test Circuit</p> 	<p style="text-align: center;">Unclamped Inductive Switching (UIS) Test Waveforms</p> 
<p style="text-align: center;">Diode Recovery Test Circuit</p> 	<p style="text-align: center;">Diode Recovery Test Waveforms</p> 

Package Description

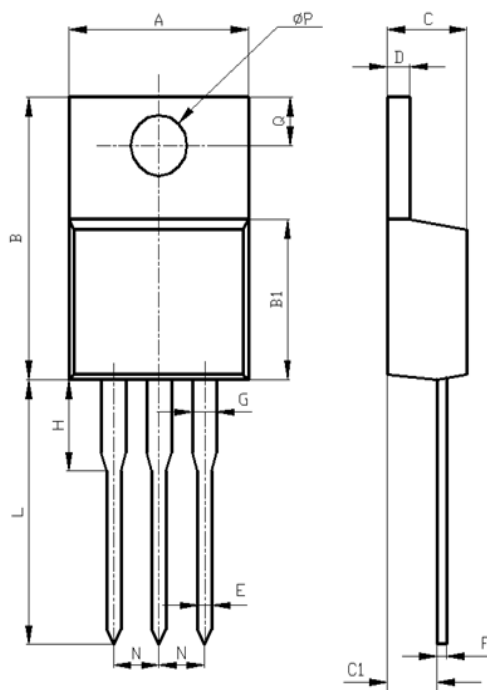

Items	Values(mm)	
	MIN	MAX
A	9.60	10.6
B	15.0	16.0
B1	8.90	9.50
C	4.30	4.80
C1	2.30	3.10
D	1.20	1.40
E	0.70	0.90
F	0.30	0.60
G	1.17	1.37
H	2.70	3.80
L	12.6	14.8
N	2.34	2.74
Q	2.40	3.00
Φ P	3.50	3.90

TO-220 Package

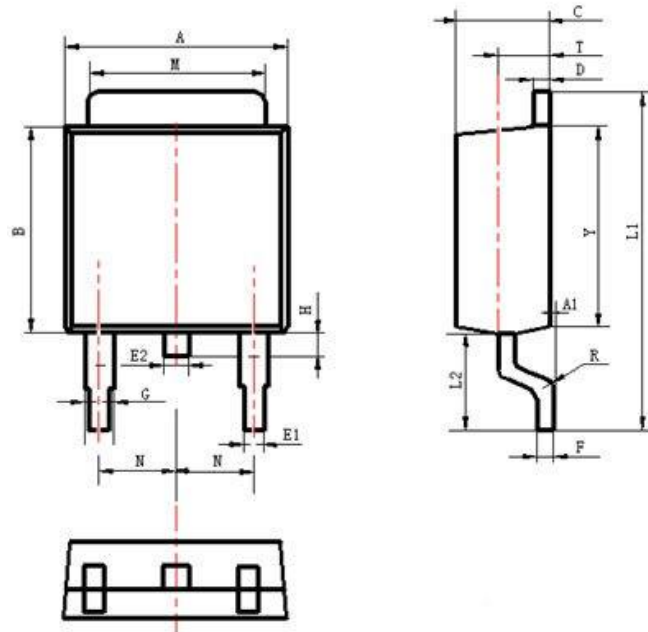

Items	Values(mm)	
	MIN	MAX
A	6.30	6.90
A1	0	0.13
B	5.70	6.30
C	2.10	2.50
D	0.30	0.60
E1	0.60	0.90
E2	0.70	1.00
F	0.30	0.60
G	0.70	1.20
L1	9.60	10.50
L2	2.70	3.10
H	0.60	1.00
M	5.10	5.50
N	2.09	2.49
R	0.3	
T	1.40	1.60
Y	5.10	6.30

TO-252 Package