

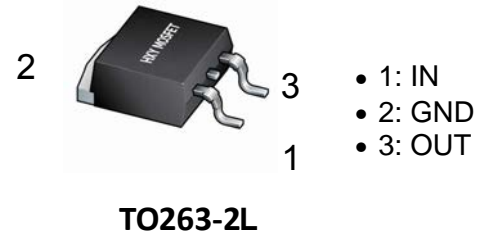

FEATURES

- Maximum output current I_{OM} : 1A
- Output voltage V_O : 5V
- Continuous total dissipation P_D : 1.5 W ($T_a=25^\circ\text{C}$)



ABSOLUTE MAXIMUM RATINGS (Operating temperature range applies unless otherwise specified)

Parameter	Symbol	Value	Unit
Input Voltage	V_i	35	V
Thermal Resistance from Junction to Air	$R_{\theta JA}$	66.7	$^\circ\text{C}/\text{W}$
Operating Junction Temperature Range	T_{OPR}	-25~+125	$^\circ\text{C}$
Storage Temperature Range	T_{STG}	-65~+150	$^\circ\text{C}$

ELECTRICAL CHARACTERISTICS AT SPECIFIED VIRTUAL JUNCTION TEMPERATURE ($V_i=10\text{V}, I_o=500\text{mA}, C_i=0.33\mu\text{F}, C_o=0.1\mu\text{F}$, unless otherwise specified)

Parameter	Symbol	Test conditions	Min	Typ	Max	Unit
Output voltage	V_o	25°C	4.8	5.0	5.2	V
		$7\text{V} \leq V_i \leq 20\text{V}, I_o=5\text{mA}-1\text{A}$	-25-125 $^\circ\text{C}$	4.75	5.00	5.25
Load Regulation	ΔV_o	$I_o=5\text{mA}-1\text{A}$	25°C	9	100	mV
		$I_o=250\text{mA}-750\text{mA}$	25°C	4	50	mV
Line regulation	ΔV_o	$7\text{V} \leq V_i \leq 25\text{V}$	25°C	4	100	mV
		$8\text{V} \leq V_i \leq 12\text{V}$	25°C	1.6	50	mV
Quiescent Current	I_q	25°C		5	8	mA
Quiescent Current Change	ΔI_q	$7\text{V} \leq V_i \leq 25\text{V}$	-25-125 $^\circ\text{C}$	0.3	1.3	mA
		$5\text{mA} \leq I_o \leq 1\text{A}$	-25-125 $^\circ\text{C}$	0.03	0.5	mA
Output Noise Voltage	V_N	$10\text{Hz} \leq f \leq 100\text{KHz}$	25°C	42		$\mu\text{V}/V_o$
Output voltage drift	$\Delta V_o/\Delta T$	$I_o=5\text{mA}$	-25-125 $^\circ\text{C}$	-1.1		$\text{mV}/^\circ\text{C}$
Ripple Rejection	RR	$8\text{V} \leq V_i \leq 18\text{V}, f=120\text{Hz}$	-25-125 $^\circ\text{C}$	62	73	dB
Dropout Voltage	V_d	$I_o=1\text{A}$	25°C	2		V
Output resistance	R_o	$f=1\text{KHz}$	-25-125 $^\circ\text{C}$	10		$\text{m}\Omega$
Short Circuit Current	I_{sc}	25°C		230		mA
Peak Current	I_{pk}	25°C		2.2		A

* Pulse test.

TYPICAL APPLICATION

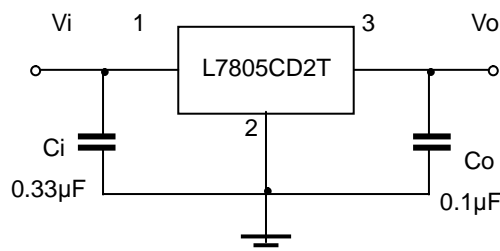

Note: Bypass capacitors are recommended for optimum stability and transient response and should be located as close as possible to the regulators.



Typical Characteristics

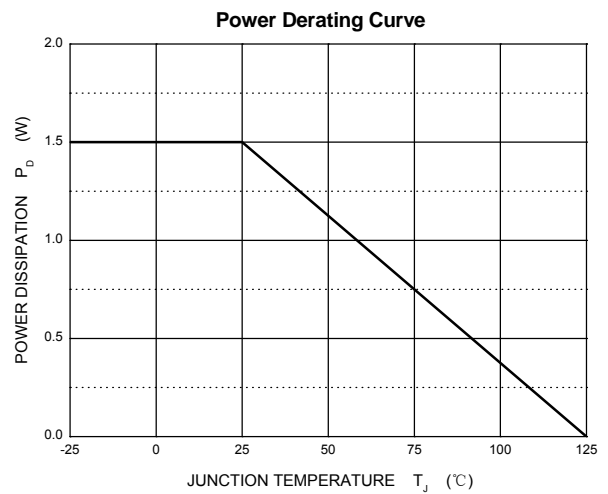
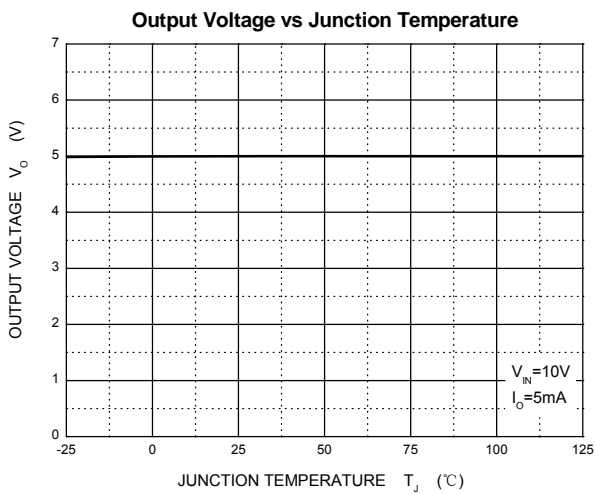
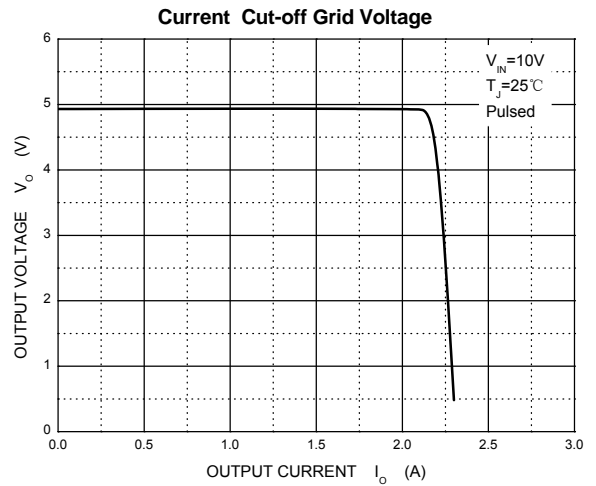
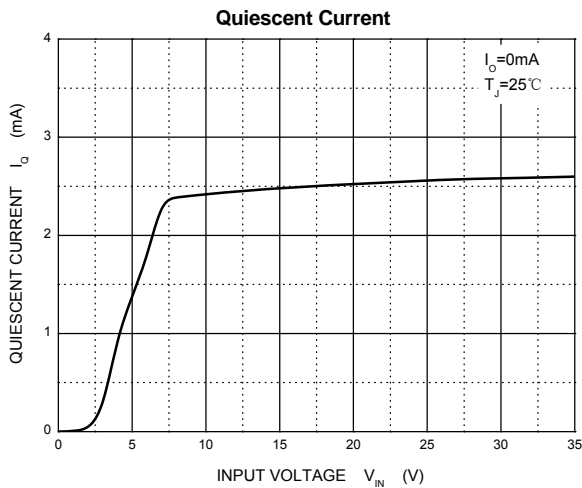
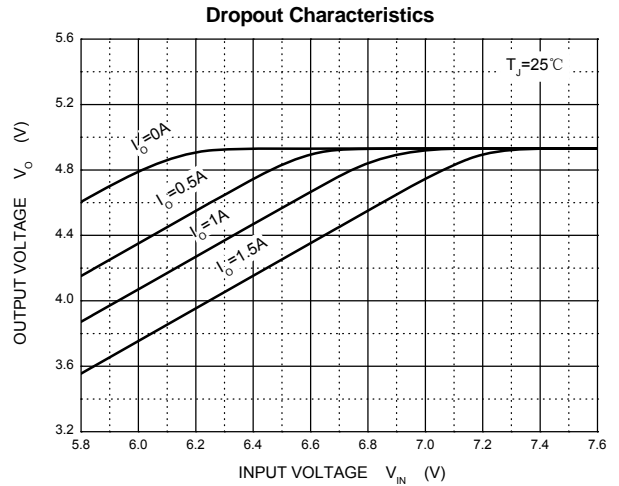
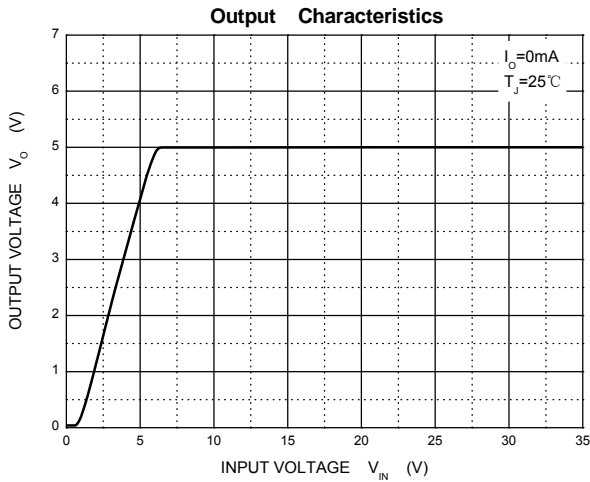



TO-263 Package Outline Dimensions

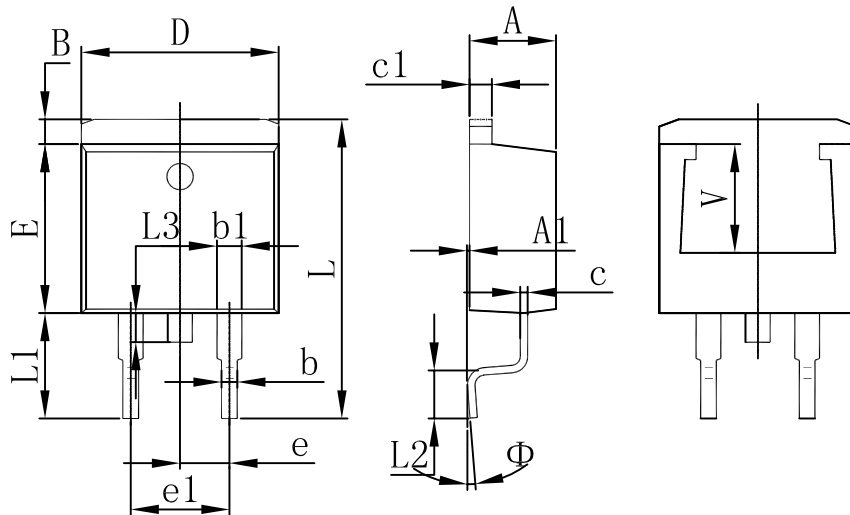

Symbol	Dimensions In Millimeters		Dimensions In Inches	
	Min.	Max.	Min.	Max.
A	4.470	4.670	0.176	0.184
A1	0.000	0.150	0.000	0.006
B	1.120	1.420	0.044	0.056
b	0.710	0.910	0.028	0.036
b1	1.170	1.370	0.046	0.054
c	0.310	0.530	0.012	0.021
c1	1.170	1.370	0.046	0.054
D	10.010	10.310	0.394	0.406
E	8.500	8.900	0.335	0.350
e	2.540 TYP.		0.100 TYP.	
e1	4.980	5.180	0.196	0.204
L	14.940	15.500	0.588	0.610
L1	4.950	5.450	0.195	0.215
L2	2.340	2.740	0.092	0.108
L3	1.300	1.700	0.051	0.067
Φ	0°	8°	0°	8°
V	5.600 REF.		0.220REF.	



Attention

- Any and all HUA XUAN YANG ELECTRONICS products described or contained herein do not have specifications that can handle applications that require extremely high levels of reliability, such as life-support systems, aircraft's control systems, or other applications whose failure can be reasonably expected to result in serious physical and/or material damage. Consult with your HUA XUAN YANG ELECTRONICS representative nearest you before using any HUA XUAN YANG ELECTRONICS products described or contained herein in such applications.
- HUA XUAN YANG ELECTRONICS assumes no responsibility for equipment failures that result from using products at values that exceed, even momentarily, rated values (such as maximum ratings, operating condition ranges, or other parameters) listed in products specifications of any and all HUA XUAN YANG ELECTRONICS products described or contained herein.
- Specifications of any and all HUA XUAN YANG ELECTRONICS products described or contained herein stipulate the performance, characteristics, and functions of the described products in the independent state, and are not guarantees of the performance, characteristics, and functions of the described products as mounted in the customer's products or equipment. To verify symptoms and states that cannot be evaluated in an independent device, the customer should always evaluate and test devices mounted in the customer's products or equipment.
- HUA XUAN YANG ELECTRONICS CO.,LTD. strives to supply high-quality high-reliability products. However, any and all semiconductor products fail with some probability. It is possible that these probabilistic failures could give rise to accidents or events that could endanger human lives, that could give rise to smoke or fire, or that could cause damage to other property. When designing equipment, adopt safety measures so that these kinds of accidents or events cannot occur. Such measures include but are not limited to protective circuits and error prevention circuits for safe design, redundant design, and structural design.
- In the event that any or all HUA XUAN YANG ELECTRONICS products(including technical data, services) described or contained herein are controlled under any of applicable local export control laws and regulations, such products must not be exported without obtaining the export license from the authorities concerned in accordance with the above law.
- No part of this publication may be reproduced or transmitted in any form or by any means, electronic or mechanical, including photocopying and recording, or any information storage or retrieval system, or otherwise, without the prior written permission of HUA XUAN YANG ELECTRONICS CO.,LTD.
- Information (including circuit diagrams and circuit parameters) herein is for example only ; it is not guaranteed for volume production. HUA XUAN YANG ELECTRONICS believes information herein is accurate and reliable, but no guarantees are made or implied regarding its use or any infringements of intellectual property rights or other rights of third parties.
- Any and all information described or contained herein are subject to change without notice due to product/technology improvement, etc. When designing equipment, refer to the "Delivery Specification" for the HUA XUAN YANG ELECTRONICS product that you intend to use.