

Silicon Carbide Schottky Diode 650V, 6A, 15nC

General Description

This product family offers state of the art performance. It is designed for high frequency applications where high efficiency and high reliability are required.

Features

- Zero Forward/Reverse Recovery
- High Blocking Voltage
- High Frequency Operation
- Positive Temperature Coefficient on V_F
- Temperature Independent Switching Behavior

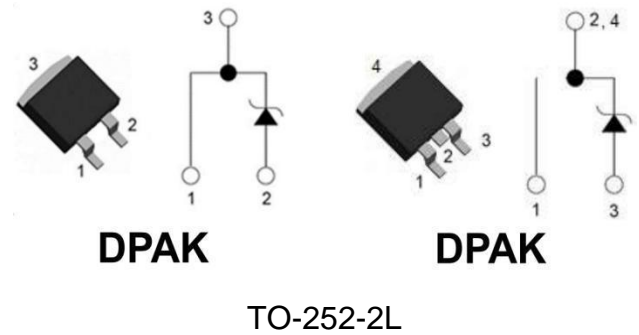

Applications

- Switch Mode Power Supplies
- Server Power Supplies
- Solar Inverters
- AC/DC converters
- DC/DC converters
- Uninterruptable power supplies

Benefits

- Higher System Efficiency
- Parallel Device Convenience
- High Frequency Operation
- High Temperature Application
- Hard Switching & High Reliability
- Environmental Protection

Key performance parameters

Type	V_R	I_F $T_C=150^\circ\text{C}$	Q_C
KN3D06065F	650V	6A	15nC

Maximum Ratings

$T_C=25^\circ\text{C}$, unless otherwise specified

Parameter	Symbol	Value	Unit
Peak Repetitive Reverse Voltage	V_{RRM}	650	V
Peak Reverse Surge Voltage	V_{RSM}	650	V
DC Blocking Voltage	V_R	650	V

Maximum Ratings

$T_C=25^\circ\text{C}$, unless otherwise specified

Parameter	Symbol	Value	Unit
Continuous Forward Current: $T_C = 25^\circ\text{C}$ $T_C = 135^\circ\text{C}$ $T_C = 150^\circ\text{C}$	I_F	19	A
		8	
		6	
Non Repetitive Forward Surge Current: $T_C = 25^\circ\text{C}$, $t_p=10\text{ms}$, Half Sine Pulse $T_C = 110^\circ\text{C}$, $t_p=10\text{ms}$, Half Sine Pulse $T_C = 25^\circ\text{C}$, $t_p=10 \mu\text{s}$, Square	I_{FSM}	40	A
		35	
		250	
Repetitive peak Forward Surge Current: Freq = 0.1Hz, 100 cycles $T_C = 25^\circ\text{C}$, $t_p=10\text{ms}$, Half Sine Pulse $T_C = 110^\circ\text{C}$, $t_p=10\text{ms}$, Half Sine Pulse	I_{FRM}	35	A
		30	
Total power dissipation : $T_C = 25^\circ\text{C}$	P_D	67	W
Operating Junction Temperature :	T_j	-55 to 175	$^\circ\text{C}$
Storage Temperature :	T_{stg}	-55 to 175	$^\circ\text{C}$

Thermal Resistance

Parameter	Symbol	Typ.	Max	Unit
Thermal resistance, junction-case	$R_{th(j-c)}$	2.25		°C/W

Electrical Characteristic

TC = 25°C, unless otherwise specified

Parameter	Symbol	Value			Unit	Test Condition
		Min.	Typ.	Max.		
DC Blocking Voltage	V_{DC}	650			V	$I_R = 250\mu A$ $T_J = 25^\circ C$
Forward Voltage	V_F		1.43 1.58 1.72	1.75	V	$I_F = 6A$ $T_J = 25^\circ C$ $T_J = 125^\circ C$ $T_J = 175^\circ C$
Reverse Current	I_R		5 38 110	50	μA	$V_R = 650V$ $T_J = 25^\circ C$ $T_J = 125^\circ C$ $T_J = 175^\circ C$
Total Capacitance Charge	Q_C		15		nC	$V_R = 400V$
Total Capacitance	C		235 28 22		pF	$T_J = 25^\circ C, F_{req} = 1MHz$ $V_R = 1V$ $V_R = 200V$ $V_R = 400V$

Characteristics Curves

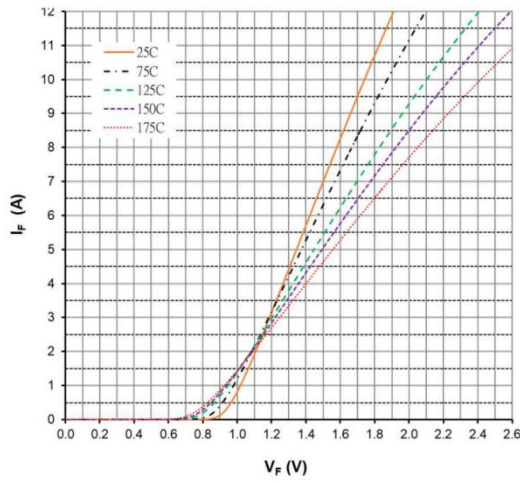

Figure 1. Forward Characteristics

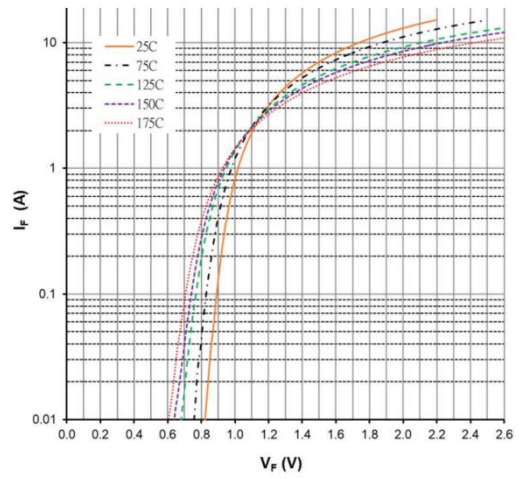

Figure 2. Forward Characteristics

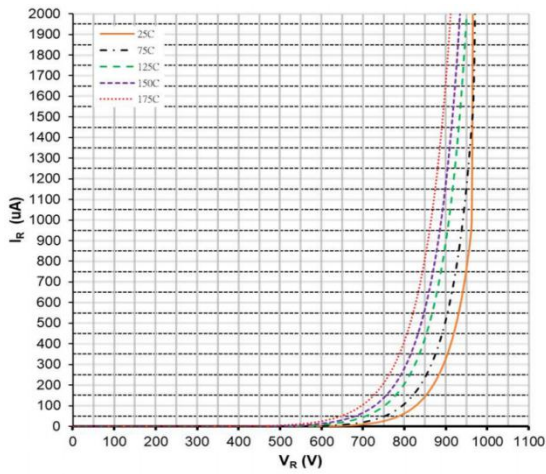

Figure 3. Reverse Characteristics

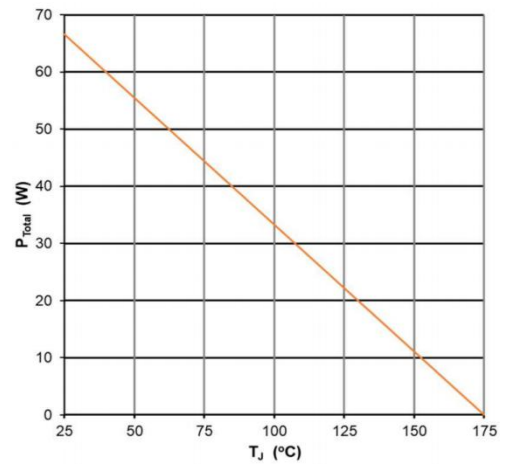

Figure 4. Power Derating

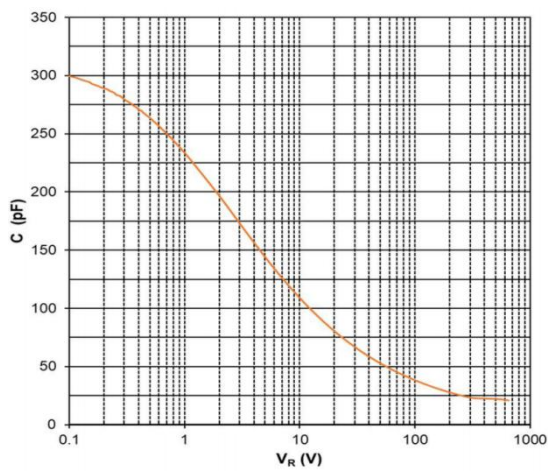

Figure 5. Capacitance vs Reverse Voltage

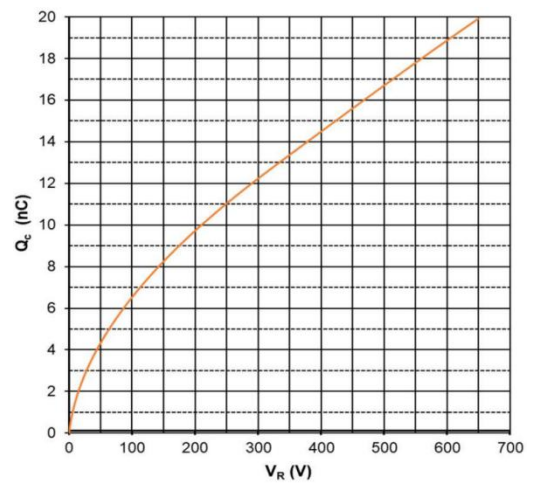
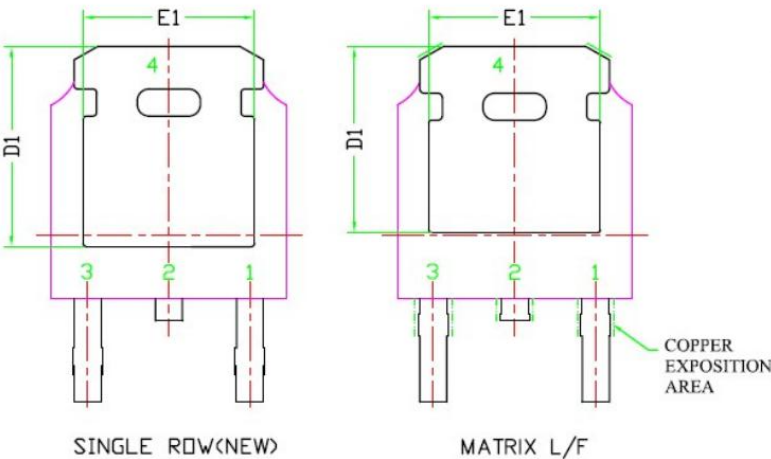
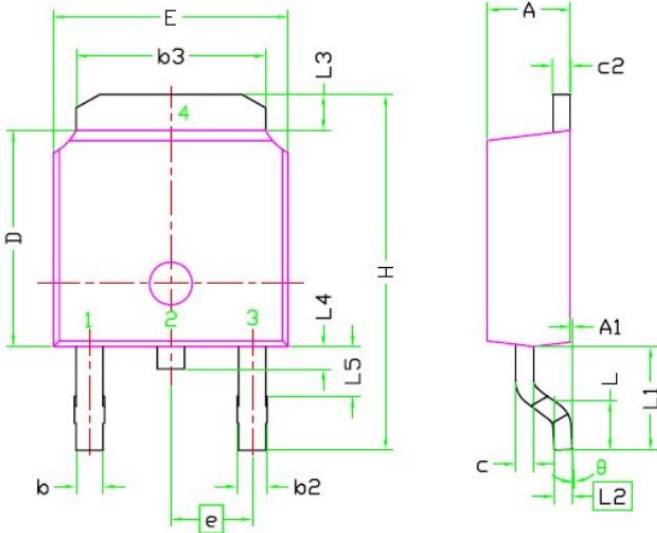

Figure 6. Recovery Charge vs Reverse Voltage

Package Dimensions: (DPAK Package)



SYMBOL	DIMENSIONAL REQMTS		
	MIN	NOM	MAX
E	6.40	6.60	6.731
L	1.40	1.52	1.77
L1	2.743 REF		
L2	0.508 BSC		
L3	0.89	--	1.27
L4	0.64	--	1.01
L5	--	--	--
D	6.00	6.10	6.223
H	9.40	10.00	10.40
b	0.64	0.76	0.88
b2	0.77	0.84	1.14
b3	5.21	5.34	5.46
e	2.286 BSC		
A	2.20	2.30	2.38
A1	0	--	0.127
c	0.46	0.50	0.60
c2	0.46	0.50	0.58
D1	5.21	--	--
E1	4.40	--	--

Note:

1. All Dimension Are In mm.
2. Package Body Sizes Exclude Mold Flash, Protrusion Or Gate Burrs. Mold Flash, Protrusion Or Gate Burrs Shall Not Exceed 0.10 mm Per Side.
3. Package Body Sizes Determined At The Outermost Extremes Of The Plastic Body Exclusive Of Mold Flash, Gate Burrs And Interlead Flash, But Including Any Mismatch Between The Top And Bottom Of The Plastic Body.
4. The Package Top May Be Smaller Than The Package Bottom.
5. Dimension "b" Does Not Include Dambar Protrusion. Allowable Dambar Protrusion Shall Be 0.10 mm Total In Excess Of "b" Dimension At Maximum Material Condition. The Dambar Cannot Be Located On The Lower Radius Of The Foot.

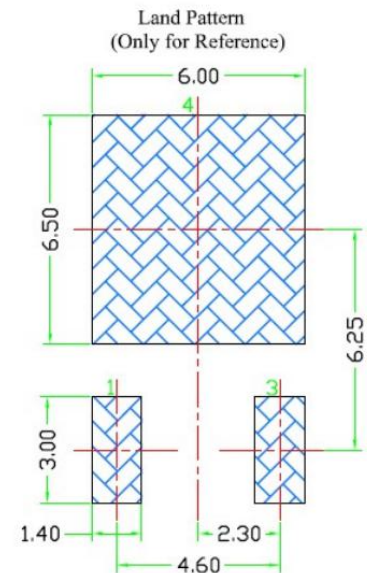

(DPAK Package)

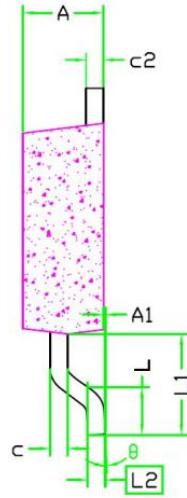
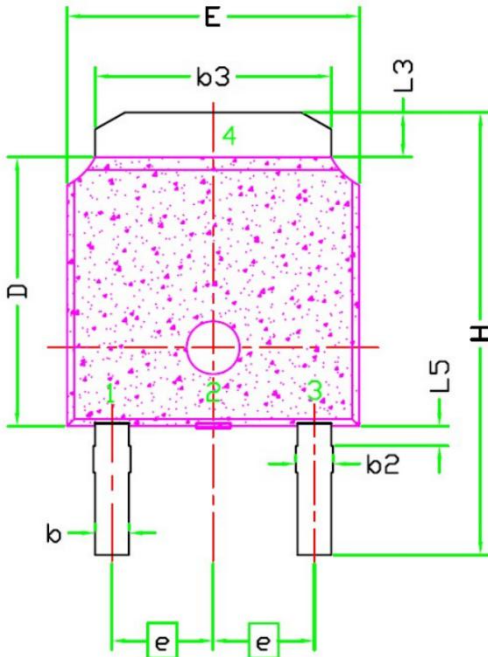

SYMBOL	DIMENSIONAL REQMTS		
	MIN	NOM	MAX
E	6.40	6.60	6.731
L	1.40	1.52	1.77
L1	2.743 REF		
L2	0.508 BSC		
L3	0.89	--	1.27
L5	--	--	--
D	6.00	6.10	6.223
H	9.40	10.00	10.40
b	0.64	0.76	0.88
b2	0.77	0.84	1.14
b3	5.21	5.34	5.46
e	2.286 BSC		
A	2.20	2.30	2.38
A1	0	--	0.127
c	0.46	0.50	0.60
c2	0.46	0.50	0.58
D1	5.21	--	--
E1	4.40	--	--
θ	0°	--	10°

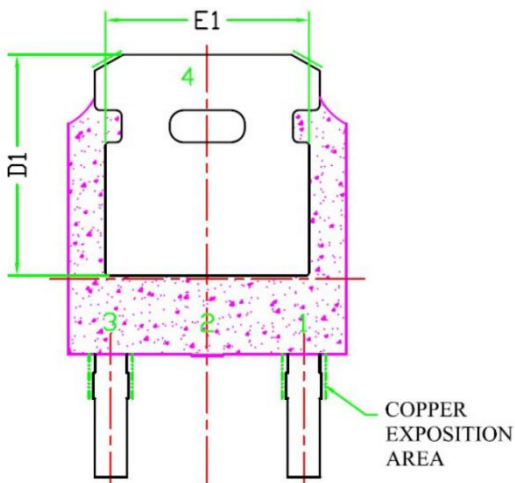

Note:

1. All Dimension Are In mm.
2. Package Body Sizes Exclude Mold Flash, Protrusion Or Gate Burrs. Mold Flash, Protrusion Or Gate Burrs Shall Not Exceed 0.10 mm Per Side.
3. Package Body Sizes Determined At The Outermost Extremes Of The Plastic Body Exclusive Of Mold Flash, Gate Burrs And Interlead Flash, But Including Any Mismatch Between The Top And Bottom Of The Plastic Body.
4. The Package Top May Be Smaller Than The Package Bottom.
5. Dimension "b" Does Not Include Dambar Protrusion. Allowable Dambar Protrusion Shall Be 0.10 mm Total In Excess Of "b" Dimension At Maximum Material Condition. The Dambar Cannot Be Located On The Lower Radius Of The Foot.

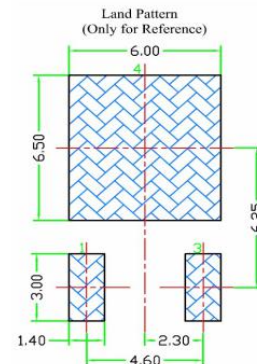

Part Number	Package	Packing	Marking	M.O.Q
KN3D06065F	TO-252-2L	2500pcs/Tape&Reel	KN3D06065F	2500