

Features

- * 450W peak pulse power (8/20 μ s)
- * Protects one data or power line
- * Operating voltage: 3.3V
- * Ultra low clamping voltage
- * Complies with following standards:
 - IEC 61000-4-2 (ESD) immunity test
 - Air discharge: ± 30 kV
 - Contact discharge: ± 30 kV
 - IEC61000-4-4 (EFT) 80A (5/50ns)
 - IEC61000-4-5 (SURGE) 38A (8/20us)

Mechanical Characteristics

- * Package: SOD123
- * Ultra low leakage: nA level
- * Case Material: "Green" Molding Compound.
- * UL Flammability Classification Rating 94V-0
- * Moisture Sensitivity: Level 3 per J-STD-020
- * Shipping Qty : 3000pcs/7Inch Tape & Reel

Applications

- * Cellular Handsets and Accessories
- * Personal Digital Assistants
- * Notebooks and Handhelds
- * Portable Instrumentation
- * Peripherals

Dimensions and Pin Configuration

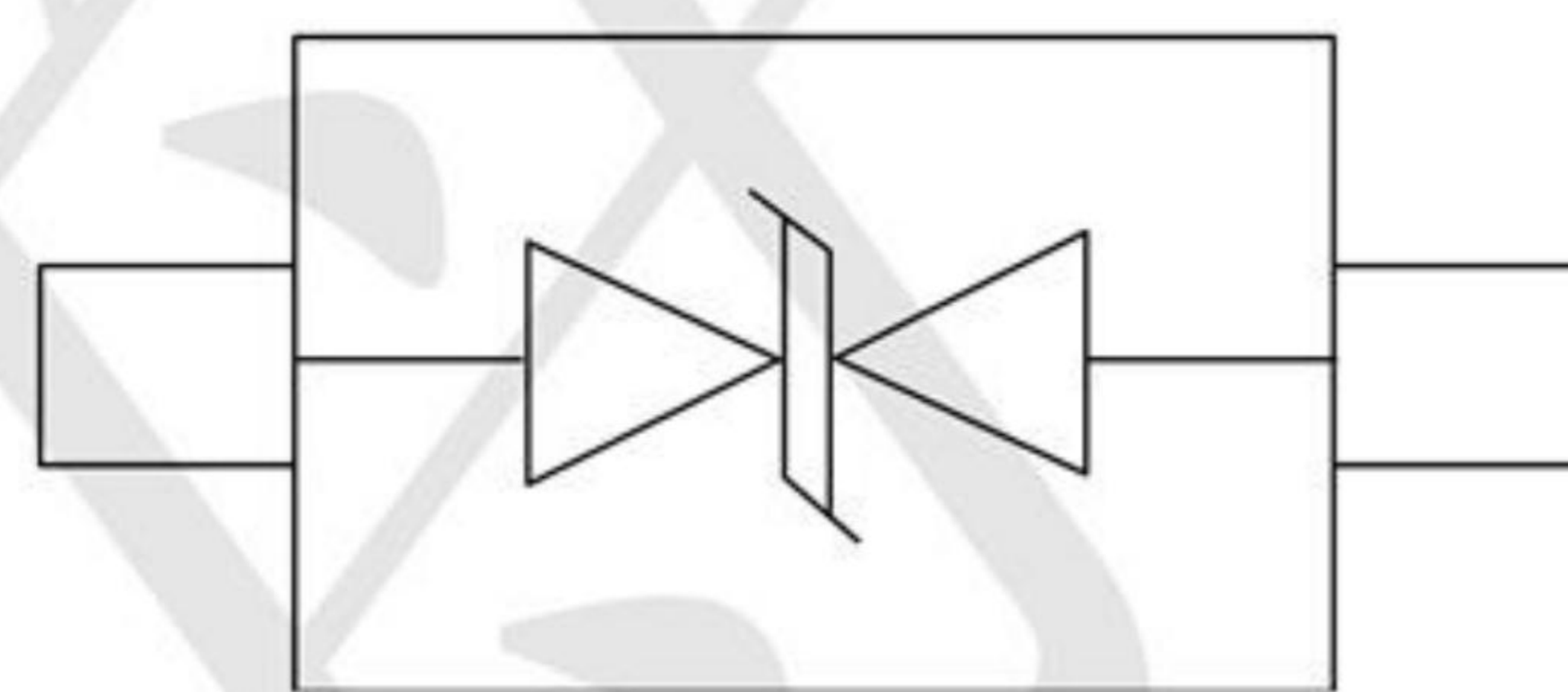

Marking: 3V3B

Absolute Maximum Ratings (Tamb=25°C unless otherwise specified)

Parameter	Symbol	Value	Unit
Peak Pulse Power (8/20μs)	Ppk	450	W
Peak Pulse Current (8/20μs)	IPP	38	A
ESD per IEC 61000-4-2 (Air)	VESD	± 30	kV
ESD per IEC 61000-4-2 (Contact)		± 30	
Operating Temperature Range	TJ	-55 to +125	°C
Storage Temperature Range	Tstg	-55 to +150	°C

Electrical Characteristics (TA=25°C unless otherwise specified)

Parameter	Symbol	Min	Typ	Max	Unit	Test Condition
Reverse Working Voltage	V _{RWM}			3.3	V	
Breakdown Voltage	V _{BR}	4.0	4.7	6.0	V	I _T =1mA
Leakage Current	I _{Leak}			200	nA	V _{RWM} =3.3V
Clamping Voltage	V _C			8.5	V	I _{PP} =20A, T _p =8/20μs
Clamping Voltage	V _C			12.0	V	I _{PP} =38A, T _p =8/20μs
Dynamic Resistance	R _{DYN}		0.1		Ω	TLP=0.2/100ns
Junction Capacitance	C _J		50	70	pF	V _R =0V, f=1MHz

Characteristic Curves

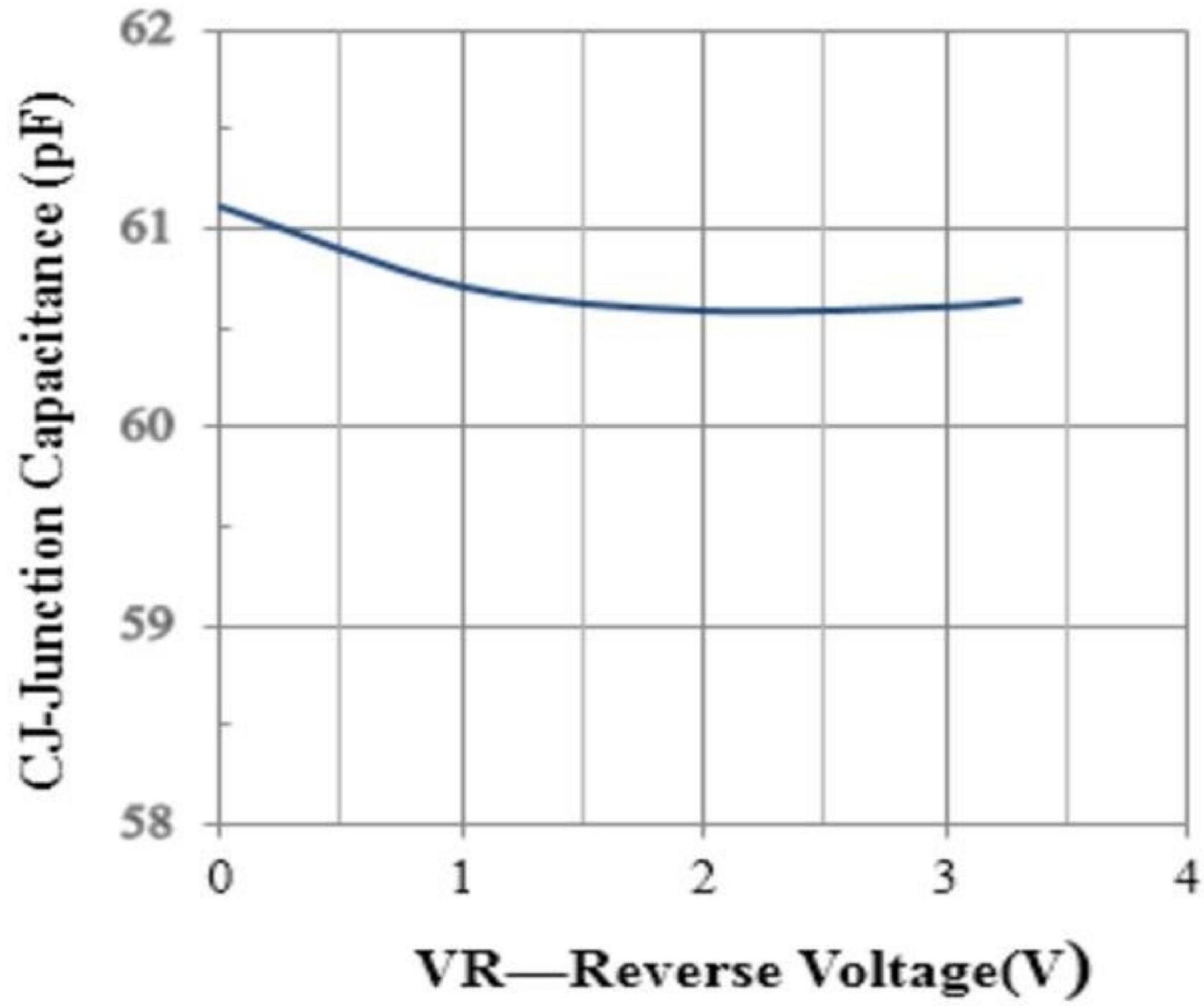

Junction Capacitance vs. Reverse Voltage

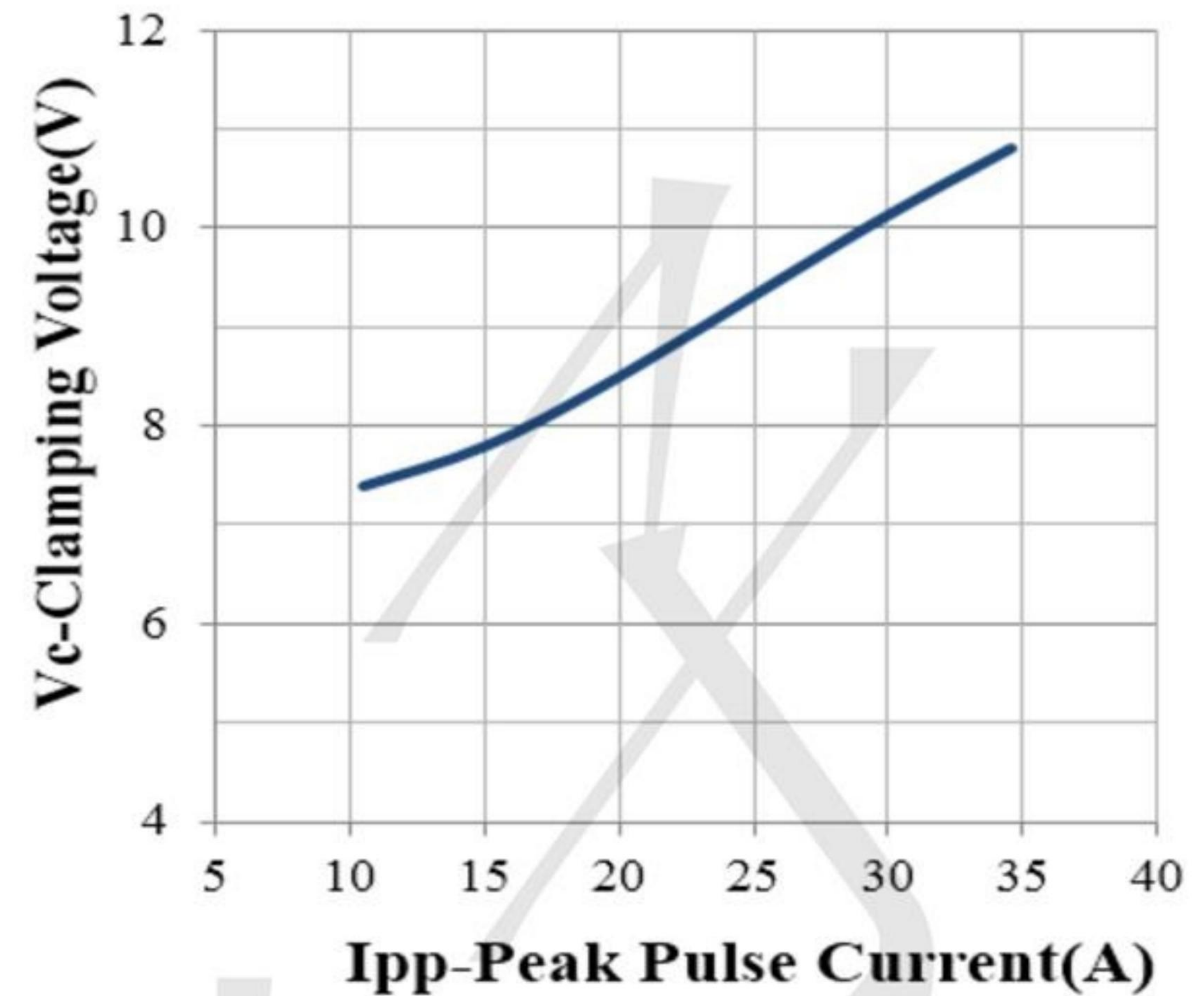

Clamping Voltage vs. Peak Pulse Current

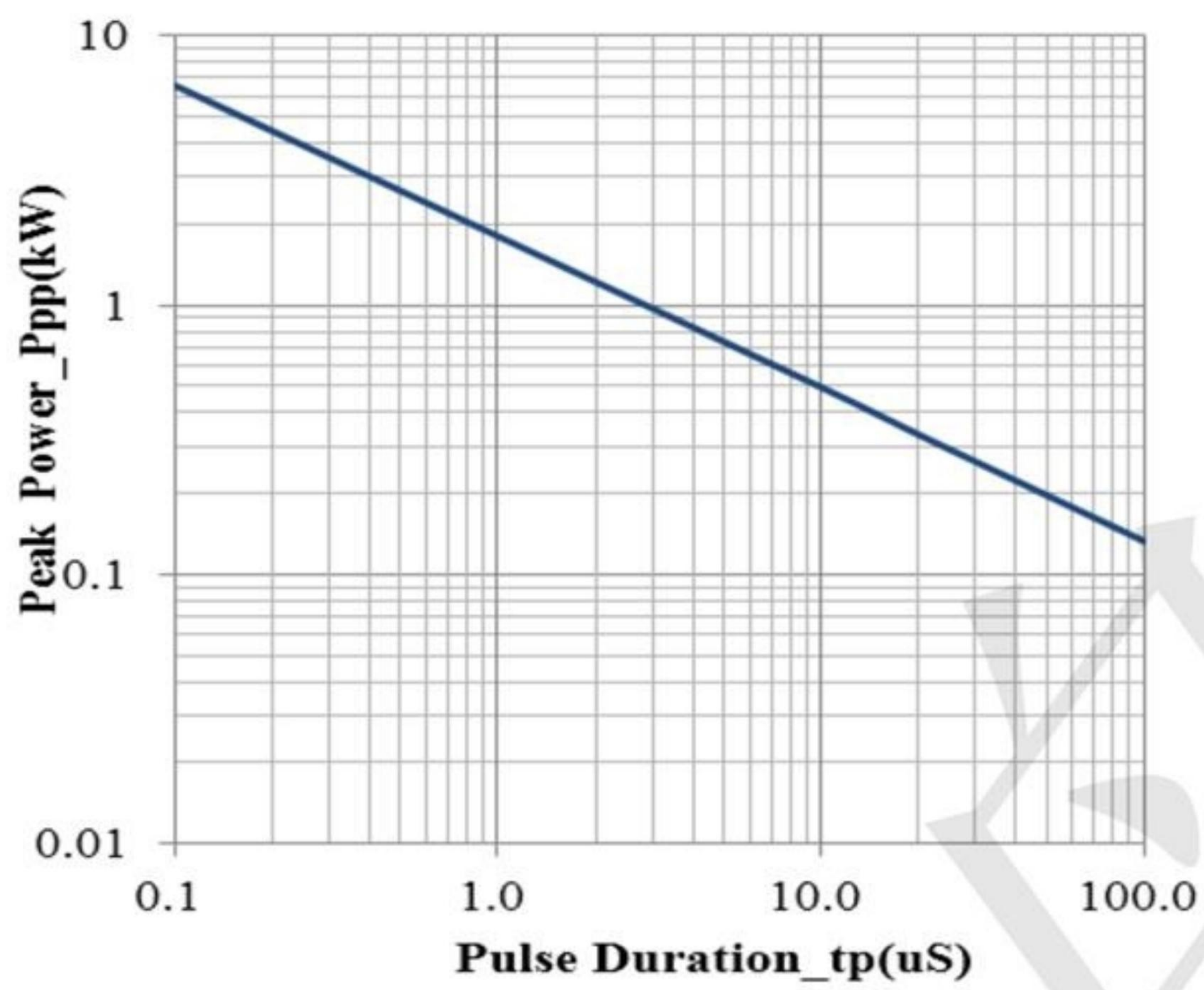

Peak Pulse Power vs. Pulse Time

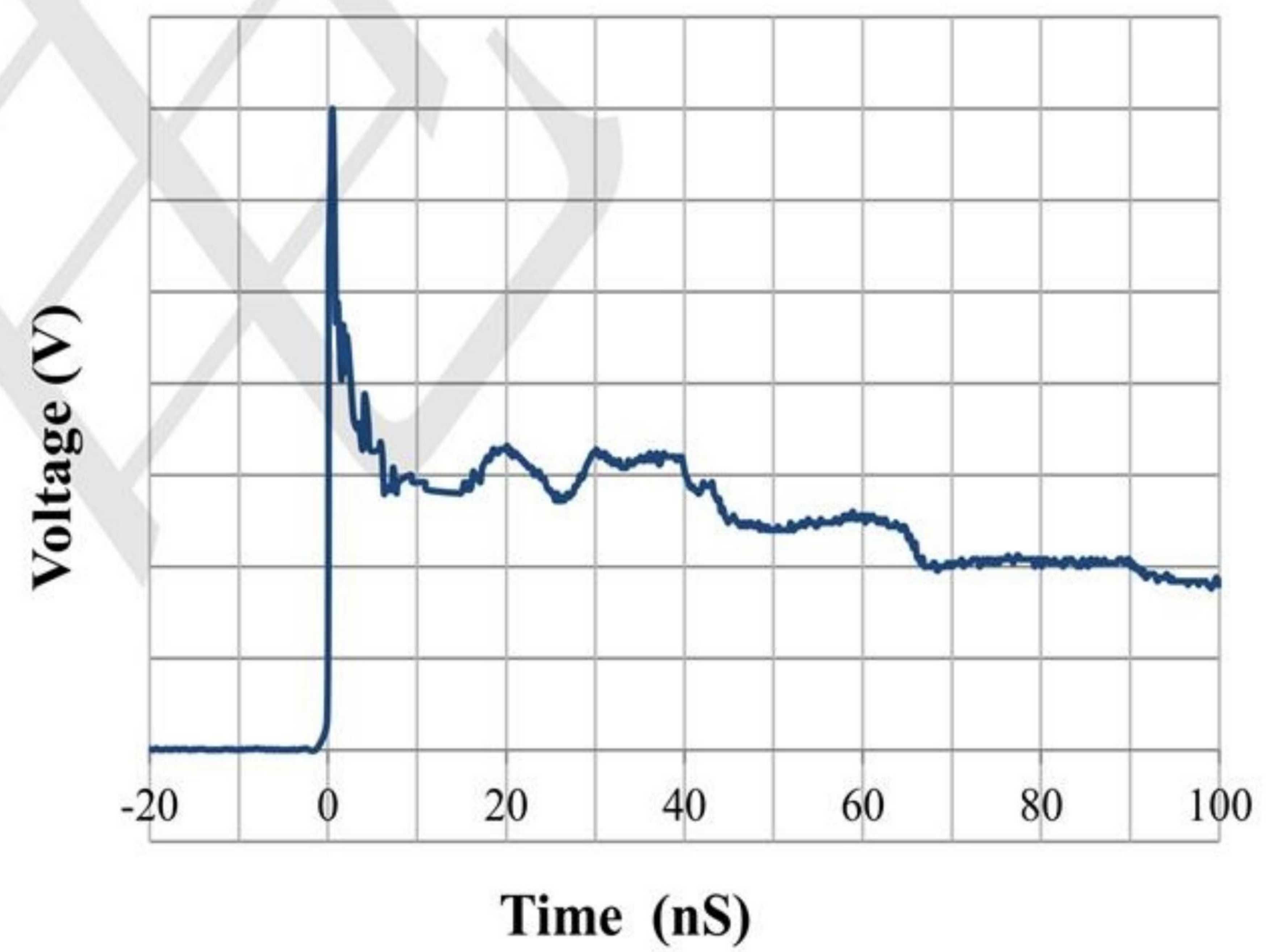

IEC61000-4-2 Pulse Waveform

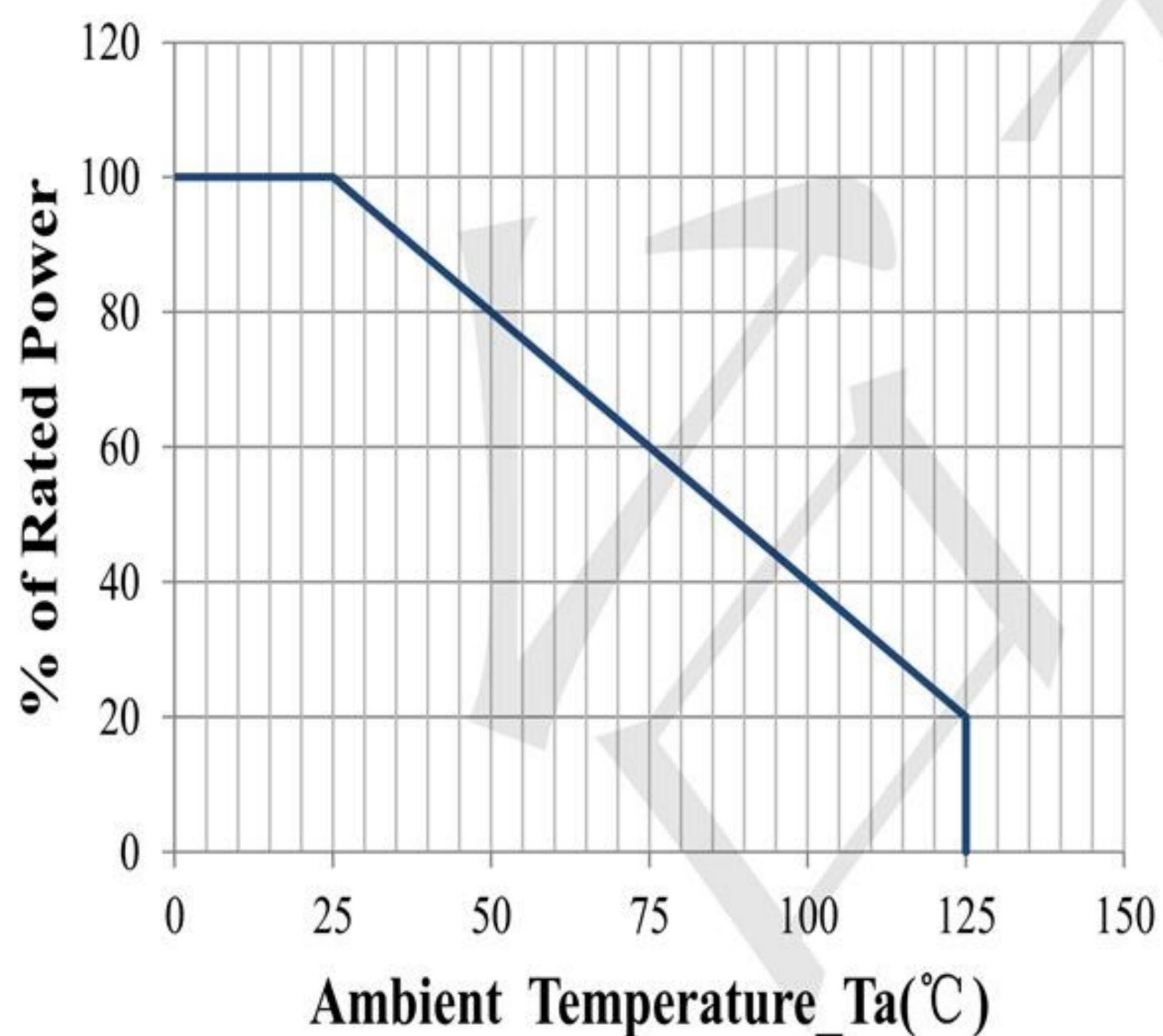

Power Derating Curve

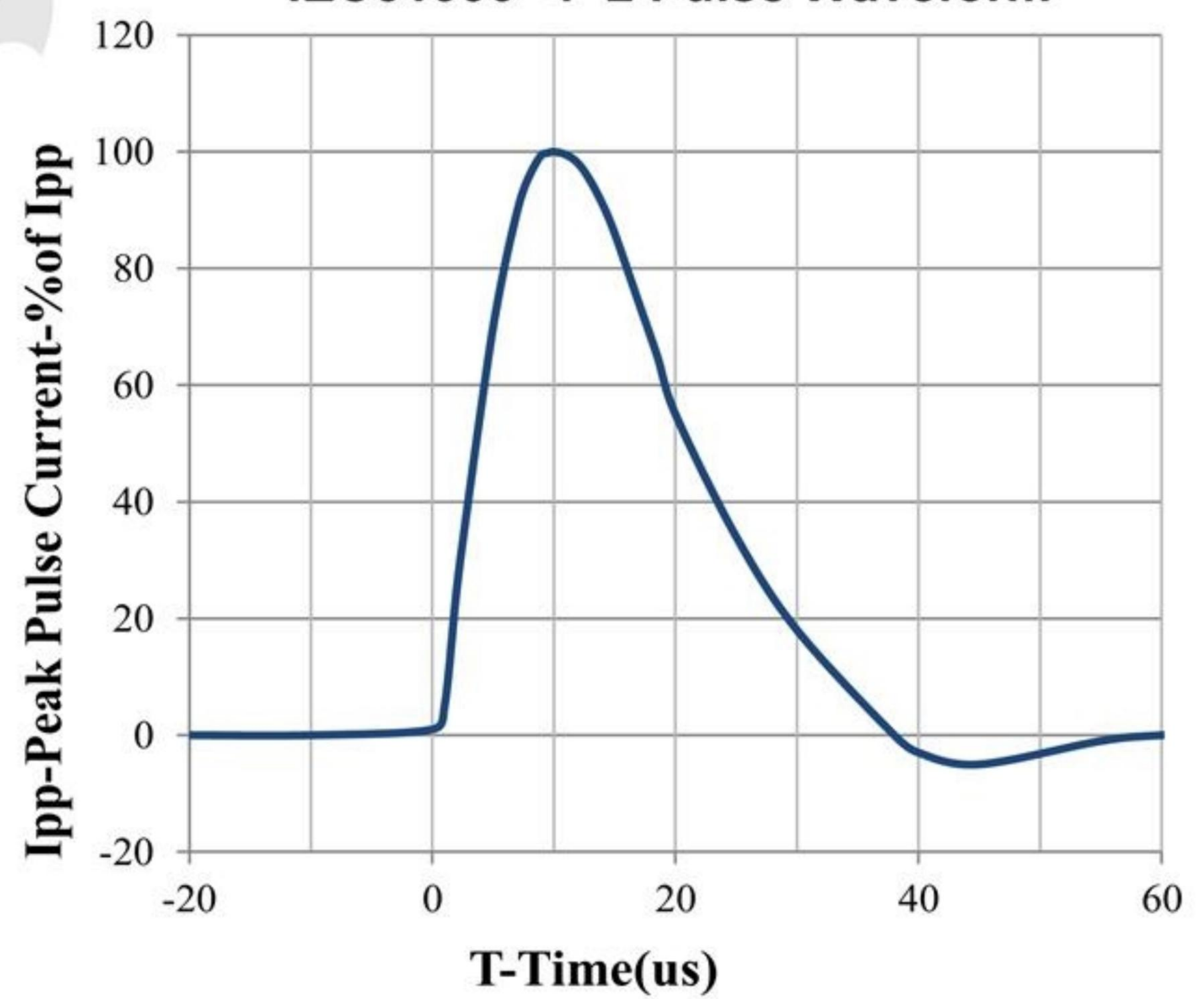

8 X 20us Pulse Waveform



Outline Drawing - SOD123 (unit: mm)

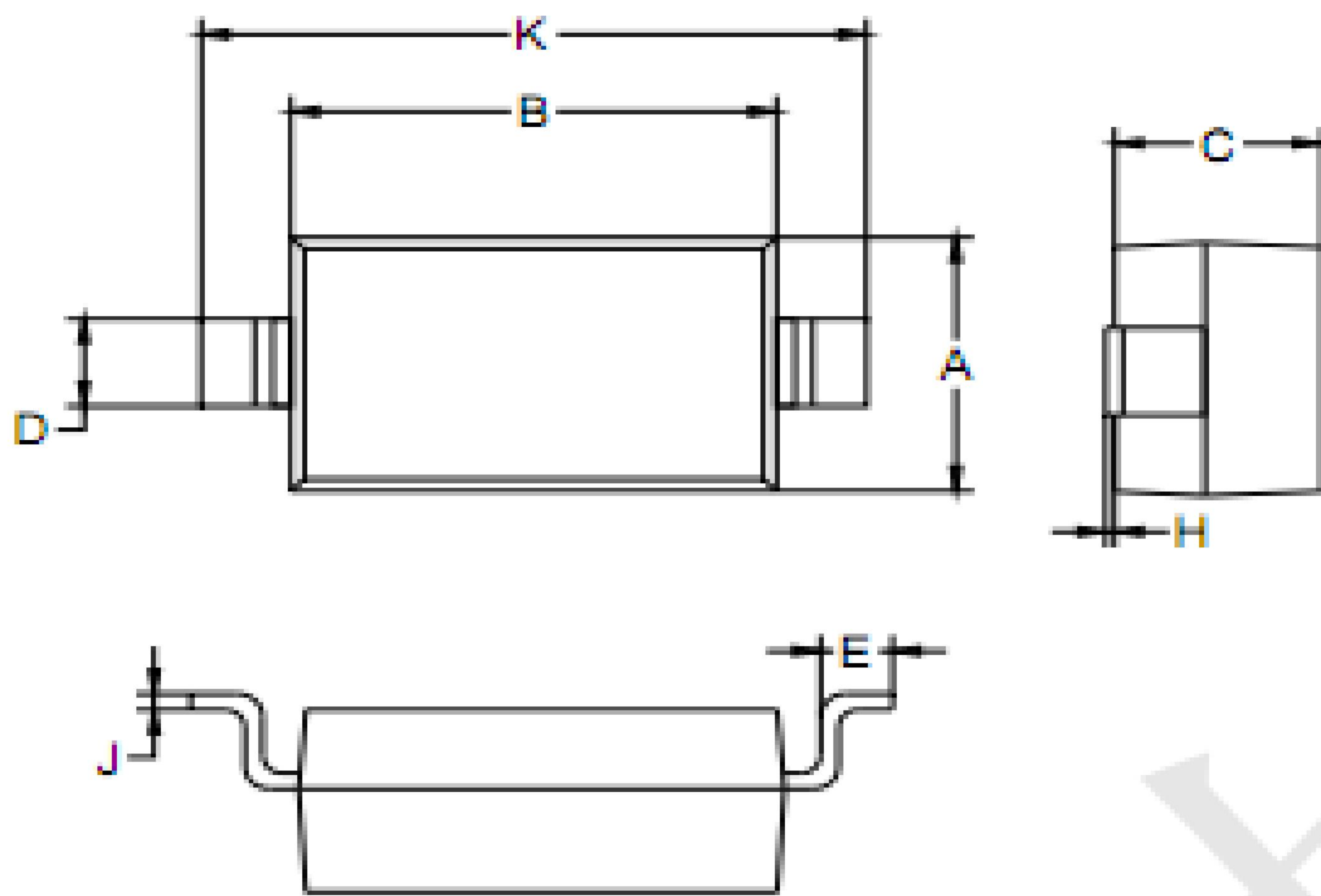

SOD-123		
Dim	Min	Max
A	1.45	1.75
B	2.55	2.85
C	1.00	1.30
D	0.50	0.60
E	0.25	0.45
H	0.02	0.10
J	0.05	0.15
K	3.55	3.85

Mounting Pad Layout-SOD123 (unit: mm)

