

编号	SCTF202305685
日期	2023/5/16
版本	B01



承认书

SPECIFICATION FOR APPROVAL

客户名称 Customer Name	:	立创商城
供应商物料名称 Part Name	:	差分输出石英晶体振荡器
产品描述 Description	:	SMD3225 100.000MHz/3.3V/HCSL
供应商物料料号 Part NO.	:	SX3DF100.000B20F30HNN
供应商名称 Supplier Name	:	深圳市星通时频电子有限公司

PLEASE CONFIRM OUR SPECIFICATION。 敬请确认规格书之内容。

CUSTOMER APPROVAL 客户审批		
物料代号 PART NO. _____		
使用于机型 USED IN MODEL: _____		
工程部	品质部	采购部

(敬请承认后返回一份, 谢谢!)

SUPPLIER APPROVAL 供应商审批		
DGN.制表人	CKD. 校对	APPD. 审核、签章
吴丽红	李霞	胡华才

地址: 深圳市南山区龙珠四路方大城T2栋10楼

Add: 10 / F, Building T2, Fangdacheng, Longzhu 4th Road, Nanshan District, Shenzhen, China.

Website: www.sctf-crystal.com

Email: info@sctf-crystal.com

TEL: 0755-86097430

FAX: 0755-86097259

Page : 1

■ Electrical Specification 电气参数

No.	Item	Electrical Spec.	Notes
1	Holder Type 封装	SMD3225	
2	Nominal Frequency 标称频率	100.000000 MHz	
3	Frequency Stability 常温频差	±20ppm	at 25°C ±2°C
4	Temperature Drift 温度频差	±30ppm	at - 40°C ~+85 °C
5	Operating Voltage 工作电压	3.3V	± 5% max.
6	Output 输出模式	HCSL	
7	Output Load 输出负载	50Ω	
8	Current Consumption 消耗电流	50 mA Max.	at maximum supply voltage
9	Operating Temperature Range 工作温度范围	-40°C ~ +85°C	
10	Storage Temperature Range 存储温度范围	-55°C ~ +125°C	
11	Duty Cycle 占空比	45% ~ 55%	
12	Rise / Fall Time 上升/下降沿时间	1 nS Max.	20~80% Vdd
13	High Output Voltage 高电平	0.66V Min.	
14	Low Output Voltage 低电平	0.15V Max.	
15	Start-up Time 起振时间	10 mS Max.	to 90% of final amplitude
16	Phase Noise 相位噪声	-120dBc/Hz Max.	at 1KHz offset
17	RMS Phase Jitter 均方根抖动	0.5pSec Max.	Period Jitter(12KHz-20MHz)
18	Enable Voltage High (Logic 1) 使能高电平	70%Vdd Min.	Pin 1 Tri-state Outputs will be enable if OE is Logic 1 or open;
19	Enable Voltage Low (Logic 0) 使能低电平	30%Vdd Max.	Outputs will be disable if OE is Logic 0. 输出使能OE是高电平1或者悬空,频率输出; 输出使能OE是低电平0,则无频率输出.
20	Aging 老化	±3ppm	1st. Year at 25°C

SHENZHEN SCTF ELECTRONICS CO., LTD

DATE	Specification of differential output oscillator 差分输出石英晶体振荡器规格书	Page:
2023/5/16	P/N: SX3DF100.000B20F30HNN Spec.NO.: SCTF202305685	3

■ DIMENSIONS 产品尺寸

Units (单位): mm(毫米)

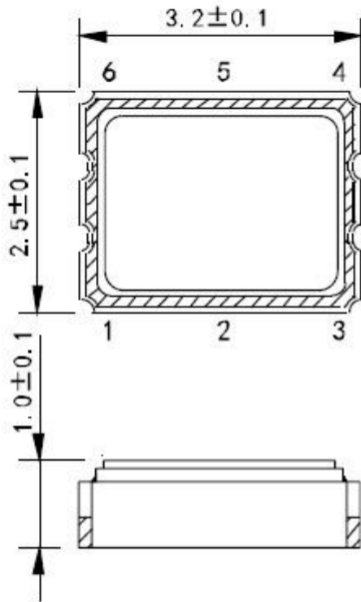

Pad Functions:

1. EN
2. NC
3. GND
4. Output
5. Comp. Output
6. Vdd

■ Pad size 焊盘尺寸

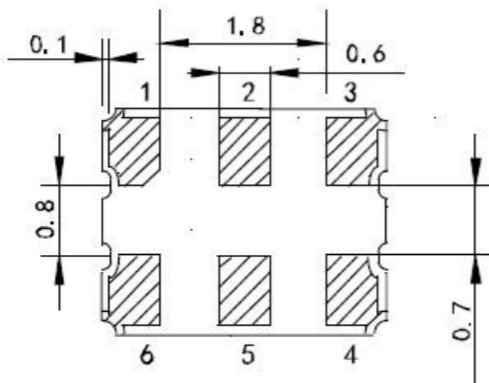

Bottom View

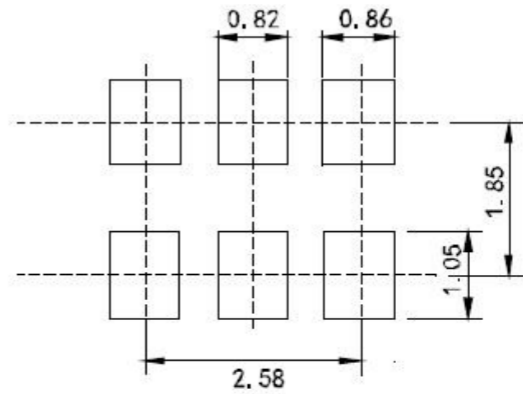

Suggested solder pad layout

■ TESTING CIRCUIT 测试电路

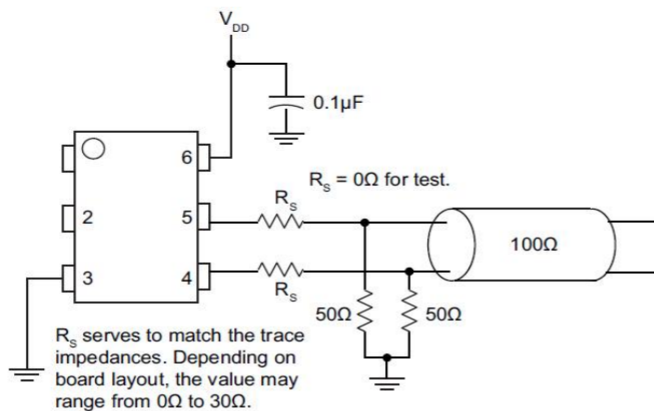

※ Notes: PIN 1 connected to Vdd or floating, the product is working properly; connected to GND, stops working.

SHENZHEN SCTF ELECTRONICS CO., LTD

DATE	Specification of differential output oscillator 差分输出石英晶体振荡器规格书	Page:
2023/5/16	P/N: SX3DF100.000B20F30HNN Spec.NO.: SCTF202305685	4

■ WAVEFORM CONDITIONS 输出波形

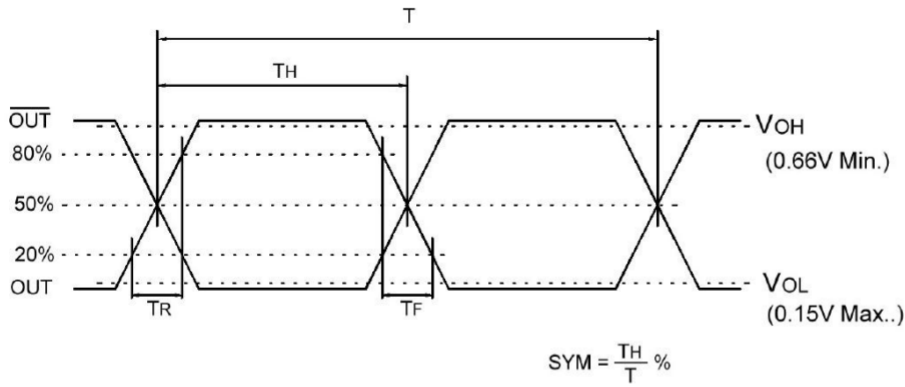

Waveform measurement system should have a min. bandwidth of 5 times the frequency being tested.

■ Product Structure 产品结构

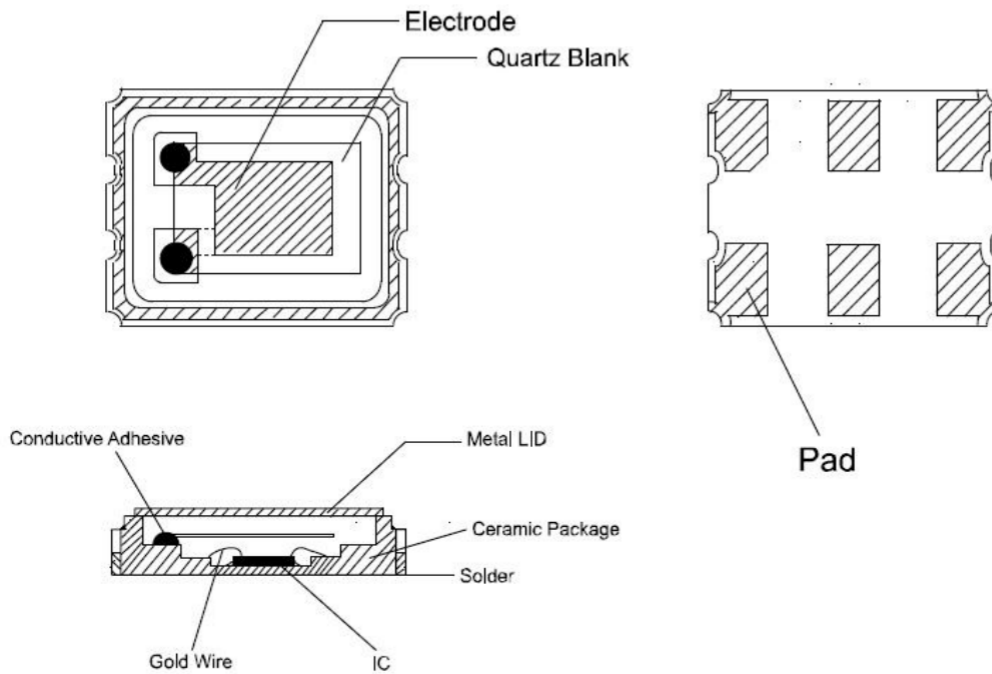

■ Marking 印字

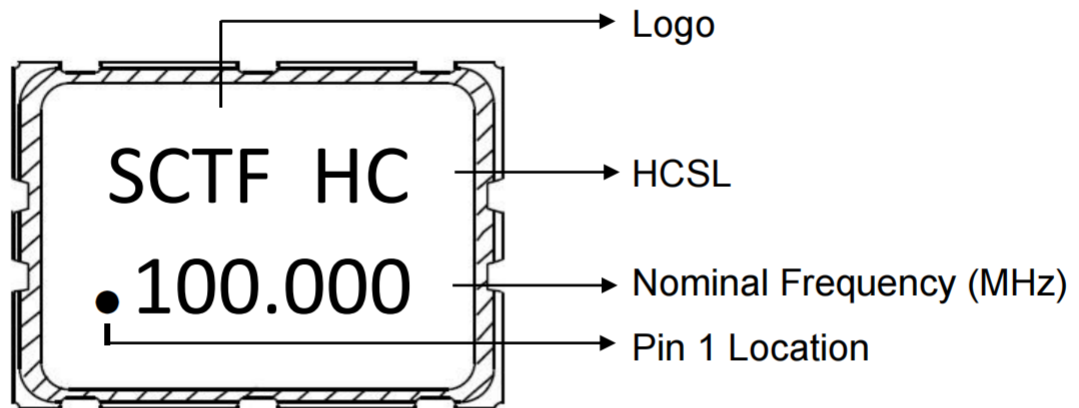

SHENZHEN SCTF ELECTRONICS CO., LTD		
DATE	Specification of differential output oscillator 差分输出石英晶体振荡器规格书	Page:
2023/5/16	P/N: SX3DF100.000B20F30HNN Spec.NO.: SCTF202305685	5

REFLOW PROFILES 回流焊条件

Profile Feature	Sn-Pb Eutectic Assembly	Pb-Free Assembly
Preheat/Soak		
● Temperature Min (T_s min)	100 °C	150 °C
● Temperature Max (T_s max)	150 °C	200 °C
● Time (T_s min to T_s max)	60-120 seconds	60-120 seconds
Ramp-up rate (TL to T_p)	3 °C/second max.	3 °C/second max.
Time maintained above		
● Liquidous temperature (TL)	183 °C	217 °C
● Time (TL) maintained above TL	60-150 seconds	60-150 seconds
Peak package body temperature (T_p)	235°C	260°C
Time within 5 °C of the specified classification temperature (T_p)	20 seconds	30 seconds
Ramp-down rate (T_p to TL)	6 °C/second max.	6 °C/second max.
Time 25 °C to peak temperature	6 minutes max.	8 minutes max.
Suggest reflow times	2 Times max.	

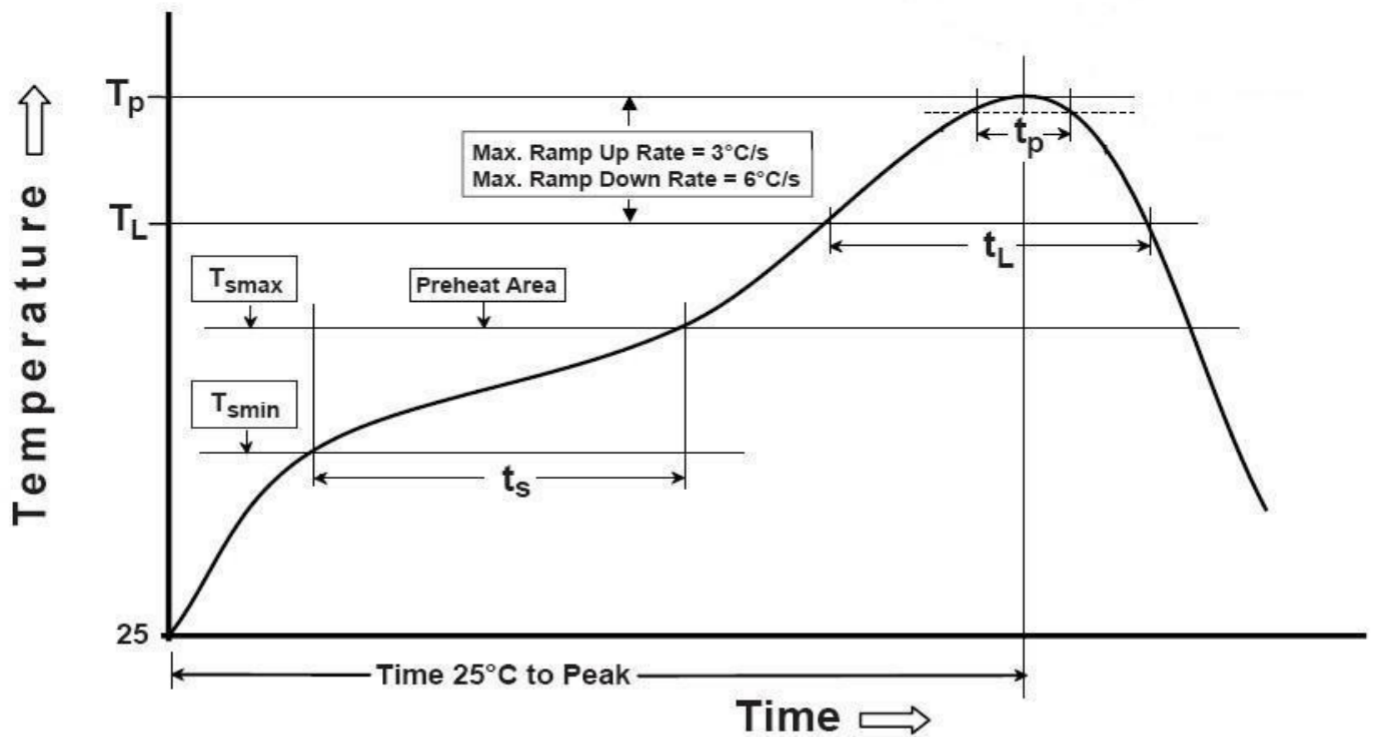

SHENZHEN SCTF ELECTRONICS CO., LTD

SHENZHEN SCTF ELECTRONICS CO., LTD		
DATE	Specification of differential output oscillator 差分输出石英晶体振荡器规格书	Page:
2023/5/16	P/N: SX3DF100.000B20F30HNN Spec.NO.: SCTF202305685	6

■ RELIABILITY SPECIFICATION 可靠性参数

No.	项目 ITEM	条件 CONDITIONS	合格标准 BASIS OF VERDICT
1	跌落 DROP	100cm高处自由跌落到3cm厚木板上,3次 High:100cm;Thickness:3cm;3 times.	$\Delta FL \leq \pm 5 \text{ppm}$
2	振动 VIBRATION	频率 Frequency:10~57.7Hz;幅度 Amplitude: $\pm 0.75 \text{mm}$ 频率Frequency:57.7Hz~500Hz;加速度幅度acceleration rate:98m/s ² 周期 Cycle time:10-500-10Hz: 15min 振动方向 Direction:X,Y, Z 振动时间 Duration: 每个方向2小时 2 h/direction.	$\Delta FL \leq \pm 5 \text{ppm}$
3	温度变化 TEMPERATURE SHOCK	-40°C $\pm 2^\circ\text{C}$ (30min) $\leftarrow \rightarrow$ 85°C $\pm 2^\circ\text{C}$ (30min);循环10次 -40°C $\pm 2^\circ\text{C}$ (30min) $\leftarrow \rightarrow$ 85°C $\pm 2^\circ\text{C}$ (30min);For 10	$\Delta FL \leq \pm 5 \text{ppm}$
4	湿热 HUMIDITY	cycles 温度:40°C $\pm 2^\circ\text{C}$;湿度90-95%;时间:96小时 Temp:40°C $\pm 2^\circ\text{C}$;Humidity:90-95%;Times:96h	$\Delta FL \leq \pm 5 \text{ppm}$
5	低温 COLD RESISTANCE	温度:-40°C $\pm 2^\circ\text{C}$;时间:96小时 Temp:-40°C $\pm 2^\circ\text{C}$;Times:96h	$\Delta FL \leq \pm 5 \text{ppm}$
6	高温1 HEAT RESISTANCE 1	温度:100°C $\pm 2^\circ\text{C}$;时间:96小时 Temp:100°C $\pm 2^\circ\text{C}$;Times:96h	$\Delta FL \leq \pm 5 \text{ppm}$
7	高温2 HEAT RESISTANCE 2	温度:155°C $\pm 2^\circ\text{C}$;时间:2小时 Temp:155°C $\pm 2^\circ\text{C}$;Times:2h	$\Delta FL \leq \pm 5 \text{ppm}$
8	高温3 HEAT RESISTANCE 3	温度:85°C $\pm 2^\circ\text{C}$;电压:3.3V/5.0V;时间:96小时 Temp:85°C $\pm 2^\circ\text{C}$;Voltage:3.3V/5.0V;Times:96h	$\Delta FL \leq \pm 5 \text{ppm}$
9	回流焊 REFLOW	150°C $\pm 5^\circ\text{C}$ 保持120s后升到270°C $\pm 5^\circ\text{C}$ 保持10s, 升温 and 保温时间小于200s, 常温放置1~2h后测定 Keep 150°C $\pm 5^\circ\text{C}$ 120s and then rose to 270°C $\pm 5^\circ\text{C}$ for 10s, warming and holding time is less than the 200s, placed at room temperature 1~2h after test	$\Delta FL \leq \pm 5 \text{ppm}$
10	盐雾 SALT SPRAY	盐雾浓度:5%;温度:35°C;时间:24小时 Salt density:5%;Temp:35°C;Times:24h	目测无明显腐蚀现象 Visual no significant corrosion
11	老化 AGING	温度:85°C;时间:30天 Temp:85°C;Times:30days	$\Delta FL \leq \pm 5 \text{ppm}$
12	气密性 LEAKAGE	氦气(0.6~0.65MPa):10分钟 He(0.6~0.65MPa):10min	$\leq 3 \times 10^{-9} \text{Pa} \cdot \text{m}^3/\text{s}$
13	焊接 SOLDER	温度:260°C $\pm 5^\circ\text{C}$ Temp:260°C $\pm 5^\circ\text{C}$	浸锡率大于90% Soldering tin rate greater than 90%

SHENZHEN SCTF ELECTRONICS CO., LTD

DATE	Specification of differential output oscillator 差分输出石英晶体振荡器规格书	Page:
2023/5/16	P/N: SX3DF100.000B20F30HNN Spec.NO.: SCTF202305685	7

■ Taping Specifications 编带规格

UNIT(单位):mm(毫米)

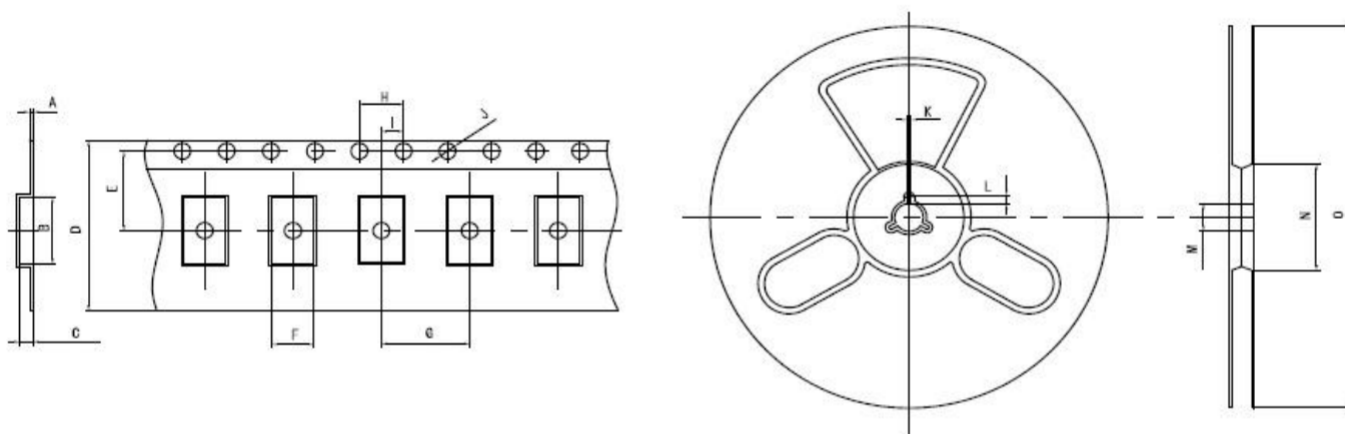

TEYE	A	B	C	D	E	F	G	H	I	J	K	L	M	N	O
3.2×2.5 SMD	0.25	3.60	1.30	8.00	3.50	2.90	4.00	4.00	2.00	1.50	2.00	4.00	13.00	60.00	180.00

■ Packaging specifications 包装规格

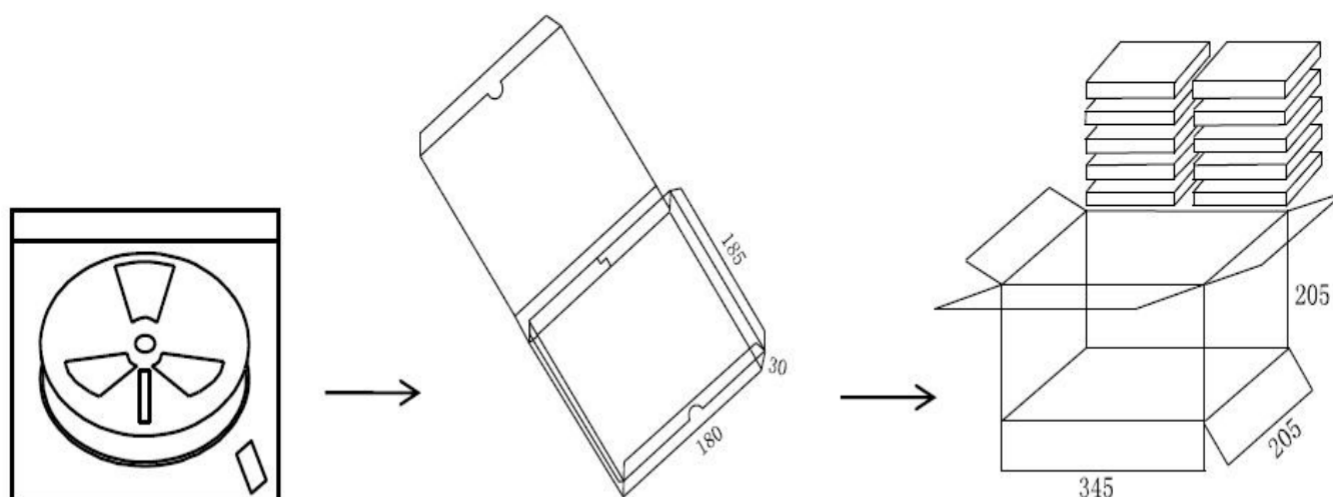

自封袋(Bag)
3000只 = 1 轮
3000pcs = 1 Reel

内包装(Inside package)
1 轮=1 盒
1 Reel=1 box

外包装(Outside Package)
10 盒=1 箱
10 box=1 carton

SHENZHEN SCTF ELECTRONICS CO., LTD

DATE

Specification of differential output oscillator
差分输出石英晶体振荡器规格书

Page:

2023/5/16

P/N: SX3DF100.000B20F30HNN
Spec.NO.: SCTF202305685

8