



SURFACE MOUNT FAST RECOVERY RECTIFIER

F1 THRU F7

VOLTAGE RANGE	50 to 1000 Volts
CURRENT	1.0 Ampere



Features

- Fast recovery glass passivated
- Low forward voltage drop
- Low leakage current
- High forward surge capability
- High temperature soldering: 260°C/10S at terminals
- Component in accordance to RoHS 2002/95/1 and WEEE 2002/96/EC

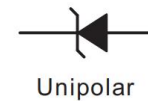

Mechanical Data

- Case: JEDEC SOD-123FL mold plastic
Body over glass passivated chip
- Terminals: Solder plated, solderable per J-STD-002B and JESD22-B102D
- Polarity: Laser band denote cathode band
- Weight: 0.00063ounce, 0.018grams

Maximum Ratings and Electrical Characteristics

- Ratings at 25°C ambient temperature unless otherwise specified
- Single Phase, half wave, 60Hz, resistive or inductive load
- For capacitive load derate current by 20%

TYPE NUMBER	SYMBOLS	F1	F2	F3	F4	F5	F6	F7	UNITS
Maximum Repetitive Peak Reverse Voltage	V_{RRM}	50	100	200	400	600	800	1000	Volts
Maximum RMS Voltage	V_{RMS}	35	70	140	280	420	560	700	Volts
Maximum DC Blocking Voltage	V_{DC}	50	100	200	400	600	800	1000	Volts
Maximum Average Forward Rectified Current	$I_{(AV)}$	1.0							Amps
Peak Forward Surge Current 8.3mS single half sine-wave superimposed on rated load (JEDEC method)	I_{FSM}	30							Amps
Maximum Instantaneous Forward Voltage at 1.0A	V_F	1.3							Volts
Maximum DC Reverse Current at Rated DC Blocking Voltage	$T_A = 25^\circ\text{C}$	5.0							μA
	$T_A = 125^\circ\text{C}$	50							
Maximum Reverse Recovery Time ^(NOTE1)	T_{RR}	150				250	500		nS
Typical Junction Capacitance ^(NOTE2)	C_j	15							pF
Typical Thermal Resistance ^(NOTE 3)	$R_{\theta JA}$	60							$^\circ\text{C}/\text{W}$
Operating and Storage Temperature Range	T_J, T_{STG}	-55 to +150							$^\circ\text{C}$

Notes:

- 1.Reverse Recovery Test Conditions: $I_f=0.5\text{A}, I_r=1.0\text{A}, I_{rr}=0.25\text{A}$.
- 2.Measured at 1.0MHz and applied reverse voltage of 4.0 Volts.
- 3.Thermal Resistance from Junction to Ambient at 5.0×5.0mm² copper pad areas.



SURFACE MOUNT FAST RECOVERY RECTIFIER

F1 THRU F7

VOLTAGE RANGE	50 to 1000 Volts
CURRENT	1.0 Ampere

Ratings and Characteristic Curves ($T_A=25^\circ\text{C}$ unless otherwise noted)

FIG.1-TYPICAL FORWARD CURRENT DERATING CURVE

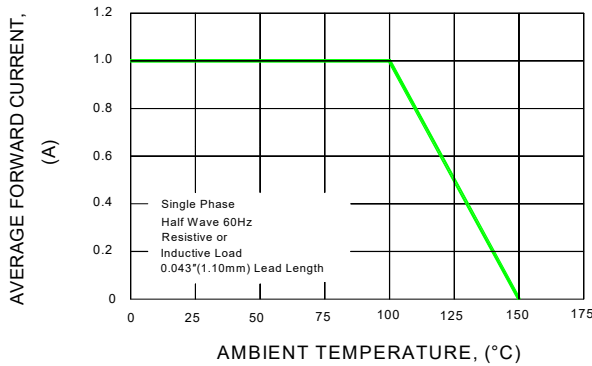

FIG.2-MAXIMUM NON-REPETITIVE PEAK FORWARD SURGE CURRENT

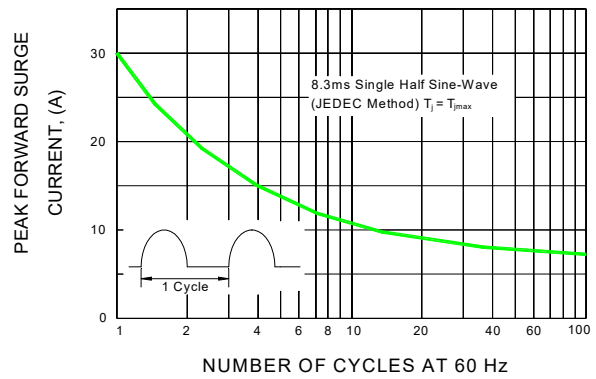

FIG.3-TYPICAL INSTANTANEOUS FORWARD CHARACTERISTICS

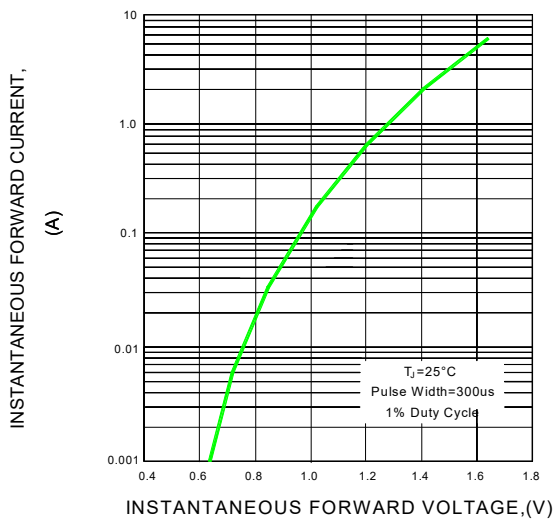

FIG.4-TYPICAL REVERSE CHARACTERISTICS

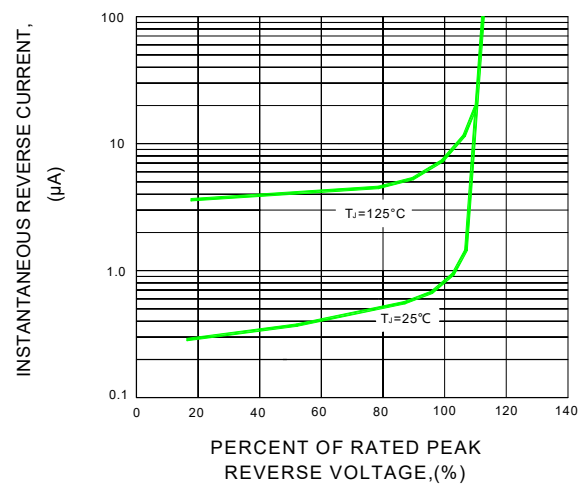

FIG.5-TYPICAL JUNCTION CAPACITANCE

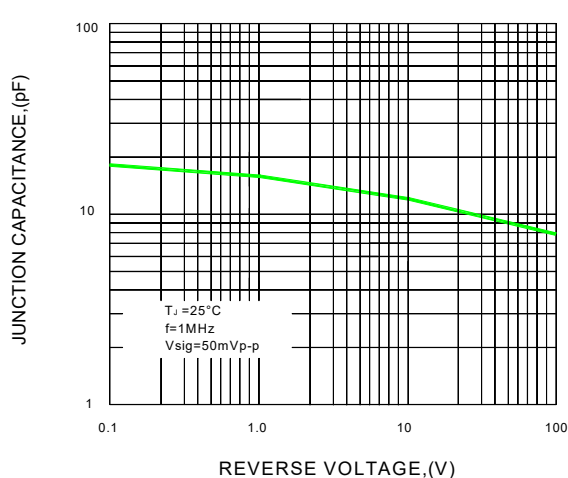
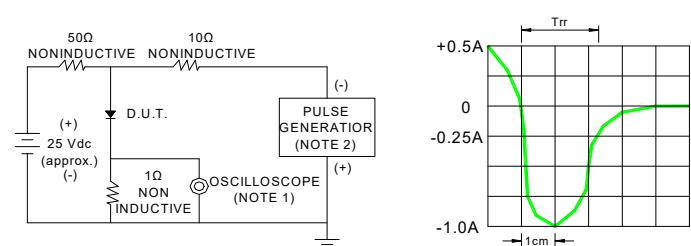

FIG.6-TEST CIRCUIT DIAGRAM AND REVERSE RECOVERY TIME CHARACTERISTIC



NOTES : 1.Rise Time=7ns max. Input Impedance= 1 magohm. 22pF
2.Rise time=10ns max. Source Impedance= 50 ohms

SET TIME BASE FOR 50/100ns/cm



Package Outline Dimensions in inches (millimeters)

SOD-123FL

Unit: mm

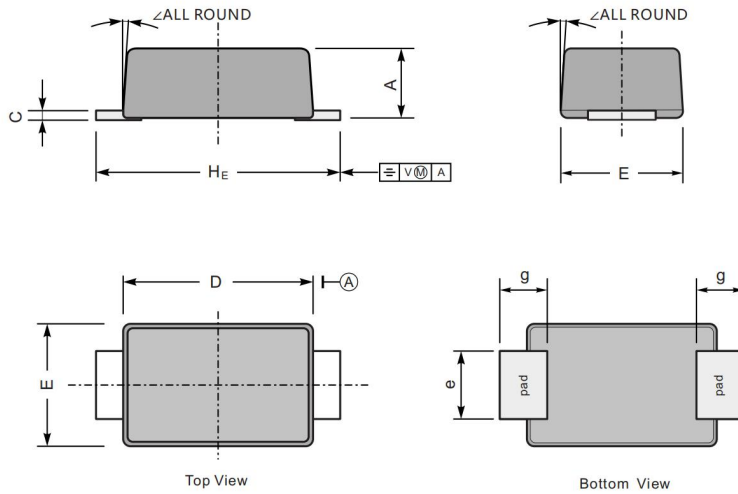

UNIT		A	C	D	E	e	g	H_E	\angle
mm	max	1.1	0.20	2.9	1.9	1.1	0.9	3.8	7°
	min	0.9	0.12	2.6	1.7	0.8	0.7	3.5	
mil	max	43	7.9	114	75	43	35	150	
	min	35	4.7	102	67	31	28	138	

The recommended mounting pad size

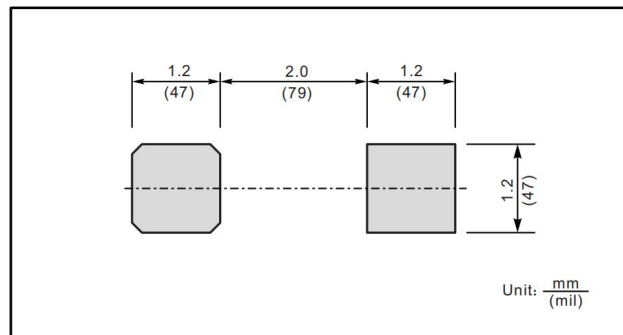



Packing Requirements

- PS black anti-static carrier tape packing

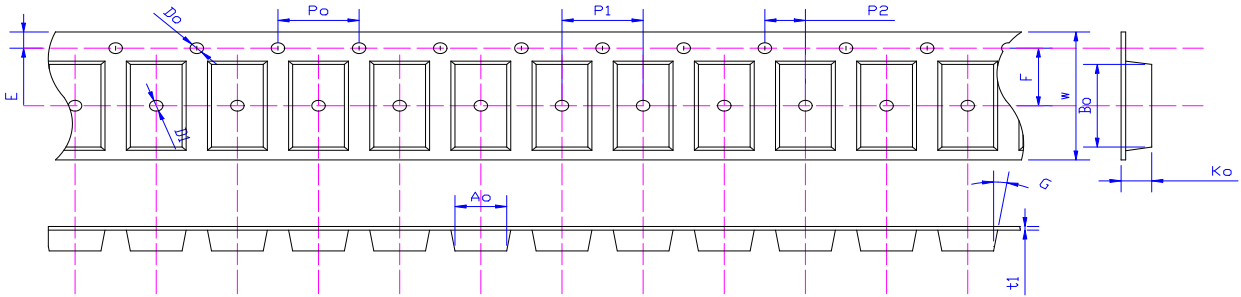

Specifications	Ao	Bo	Ko	Po	W	t1
SOD123FL	2.12±0.10	3.95±0.10	1.35±0.10	4.00±0.1	8.0±0.10	0.20±0.02

- 7" antistatic plastic reel

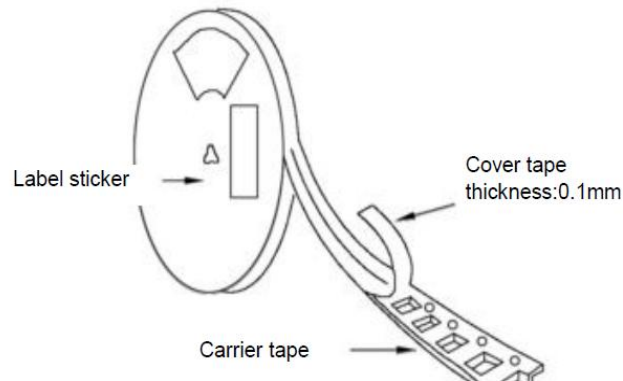

DEVICE TYPE	07" Reel			
	Q'TY/REEL(pcs)	REEL/BOX	BOX/CARTOON	Q'TY/CARTON(pcs)
SOD123FL	3000	4	16	192000



SURFACE MOUNT FAST RECOVERY RECTIFIER

F1 THRU F7

VOLTAGE RANGE	50 to 1000 Volts
CURRENT	1.0 Ampere

Marking Code

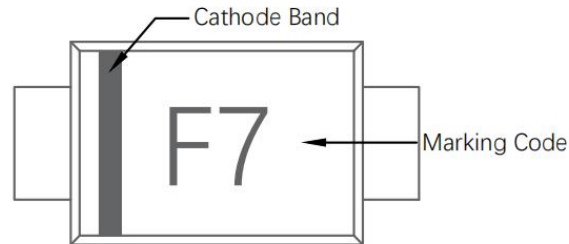

Part Number Code

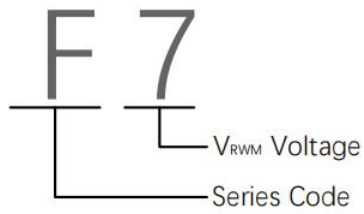



Reflow Profile

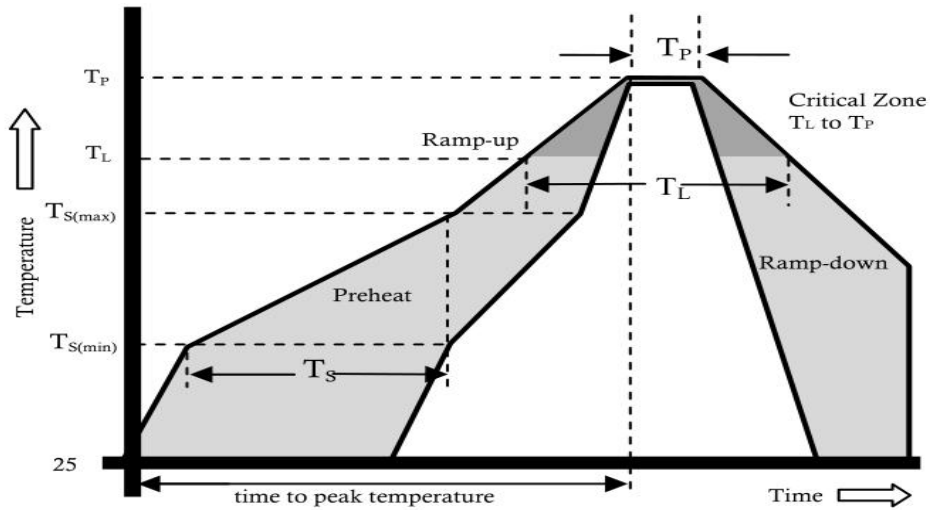

Reflow Condition		Pb-Free Assembly
Pre Heat	Temperature Min.	+150°C
	Temperature Max.	+200°C
	Time(Min to Max)	60-180 secs.
Average ramp up rate(Liquidus Temp(T_L) to peak)		3°C/sec. Max.
T_S (max) to T_L - Ramp-up Rate		3°C/sec. Max.
Reflow	Temperature (T_L)(Liquidus)	+217°C
	Temperature (T_I)	60-150 secs.
Peak Temp (T_p)		+(260+0/-5)°C
Time within 5°C of actual Peak Temp (T_p)		25 secs.
Ramp-down Rate		6°C/sec. Max.
Time 25°C to peak Temp (T_p)		8 min. Max.
Do not exceed		+260°C



F1 THRU F7

VOLTAGE RANGE	50 to 1000 Volts
CURRENT	1.0 Ampere

Disclaimer

The information presented in this document is for reference only. Chongqing changjie Electronic Technology Co., Ltd. reserves the right to make changes without notice for the specification of the products displayed herein to improve reliability, function or design or otherwise.

The product listed herein is designed to be used with ordinary electronic equipment or devices, and not designed to be used with equipment or devices which require high level of reliability and the malfunction of which would directly endanger human life (such as medical instruments, transportation equipment, aerospace machinery, nuclear-reactor controllers, fuel controllers and other safety devices), Changjie or anyone on its behalf, assumes no responsibility or liability for any damages resulting from such improper use of sale.

This publication supersedes & replaces all information previously supplied. For additional information, please visit our website [http:// www.czlangjie.com](http://www.czlangjie.com) , or consult your nearest Langjie's sales office for further assistance.