

# OSRAM SFH 4942

## Datasheet

Discontinued

**Published by ams-OSRAM AG**

Tobelbader Strasse 30, 8141 Premstaetten, Austria

Phone +43 3136 500-0

[ams-osram.com](http://ams-osram.com)

© All rights reserved



## Array Linear

# SFH 4942

Infrared Emitter Arrays (940 nm)



## Applications

- Access Control & Security
- Appliances & Tools
- Factory Automation

## Features

- Package: black epoxy
- ESD: 2 kV acc. to ANSI/ESDA/JEDEC JS-001 (HBM, Class 2)
- Wavelength 950nm
- Leadframe arrays, available from 2 to 10 Emitters per array
- Short switching times
- Same package dimensions as BPX 80 series
- Miniature package

## Ordering Information

Type	Radiant intensity <sup>1)2)</sup>  $I_F = 40 \text{ mA}; t_p = 20 \text{ ms}$ $I_e$	Radiant intensity <sup>1)</sup> typ. $I_F = 40 \text{ mA}; t_p = 20 \text{ ms}$ $I_e$	Ordering Code
SFH 4942	18 ... 112 mW/sr	50 mW/sr	Q65111A6679

## Maximum Ratings

 $T_A = 25\text{ °C}$ 

Parameter	Symbol		Values
Operating temperature	$T_{op}$	min. max.	-40 °C 80 °C
Storage temperature	$T_{stg}$	min. max.	-40 °C 80 °C
Junction temperature	$T_j$	max.	80 °C
Forward current	$I_F$	max.	40 mA
Forward current pulsed $t_p \leq 40\ \mu\text{s}$ ; $D \leq 0.005$	$I_{F\ pulse}$	max.	1 A
Reverse voltage <sup>3)</sup>	$V_R$	max.	5 V
Power consumption	$P_{tot}$	max.	70 mW
ESD withstand voltage acc. to ANSI/ESDA/JEDEC JS-001 (HBM, Class 2)	$V_{ESD}$	max.	2 kV

## Characteristics

$I_F = 40 \text{ mA}$ ;  $t_p = 20 \text{ ms}$ ;  $T_A = 25 \text{ °C}$

Parameter	Symbol		Values
Number of emitters	n		2
Dimension "B" (see drawing)	l	min. max.	4.5 mm 4.9 mm
Peak wavelength	$\lambda_{\text{peak}}$	typ.	950 nm
Centroid wavelength	$\lambda_{\text{centroid}}$	typ.	940 nm
Spectral bandwidth at 50% $I_{\text{rel,max}}$ (FWHM)	$\Delta\lambda$	typ.	42 nm
Half angle	$\varphi$	typ.	10 °
Dimensions of active chip area	L x W	typ.	0.3 x 0.3 mm x mm
Distance chip surface to lens top	H	min. max.	1.3 mm 1.9 mm
Rise time (10% / 90%) $I_F = 40 \text{ mA}$ ; $R_L = 50 \text{ }\Omega$	$t_r$	typ.	12 ns
Fall time (10% / 90%) $I_F = 40 \text{ mA}$ ; $R_L = 50 \text{ }\Omega$	$t_f$	typ.	12 ns
Forward voltage <sup>4)</sup>	$V_F$	typ. max.	1.35 V 1.6 V
Forward voltage <sup>4)</sup> $I_F = 1 \text{ A}$ ; $t_p = 100 \text{ }\mu\text{s}$	$V_F$	typ. max.	3.6 V 4.5 V
Reverse current <sup>3)</sup> $V_R = 5 \text{ V}$	$I_R$	typ. max.	0.01 $\mu\text{A}$ 10 $\mu\text{A}$
Radiant intensity <sup>1)</sup> $I_F = 1 \text{ A}$ ; $t_p = 40 \text{ }\mu\text{s}$	$I_e$	typ.	520 mW/sr
Total radiant flux <sup>5)</sup> $I_F = 40 \text{ mA}$ ; $t_p = 20 \text{ ms}$	$\Phi_e$	typ.	30 mW
Temperature coefficient of voltage	$TC_V$	typ.	-0.8 mV / K
Temperature coefficient of brightness	$TC_I$	typ.	-0.3 % / K
Temperature coefficient of wavelength	$TC_\lambda$	typ.	0.3 nm / K
Thermal resistance junction solder point real <sup>6)</sup>	$R_{\text{thJS real}}$	max.	650 K / W
Thermal resistance junction ambient real <sup>7)</sup>	$R_{\text{thJA}}$	max.	750 K / W

**Relative Spectral Emission** 8), 9)

$I_{e,rel} = f(\lambda); I_F = 40 \text{ mA}; t_p = 20 \text{ ms}$

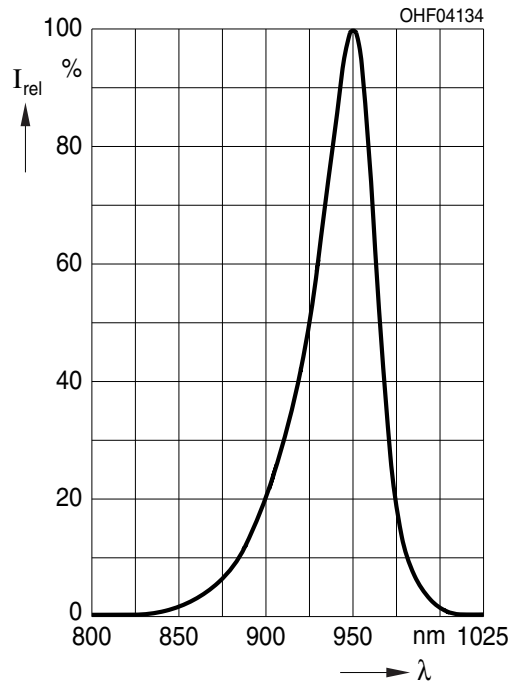

**Radiation Characteristics** 8), 9)

$I_{e,rel} = f(\varphi)$

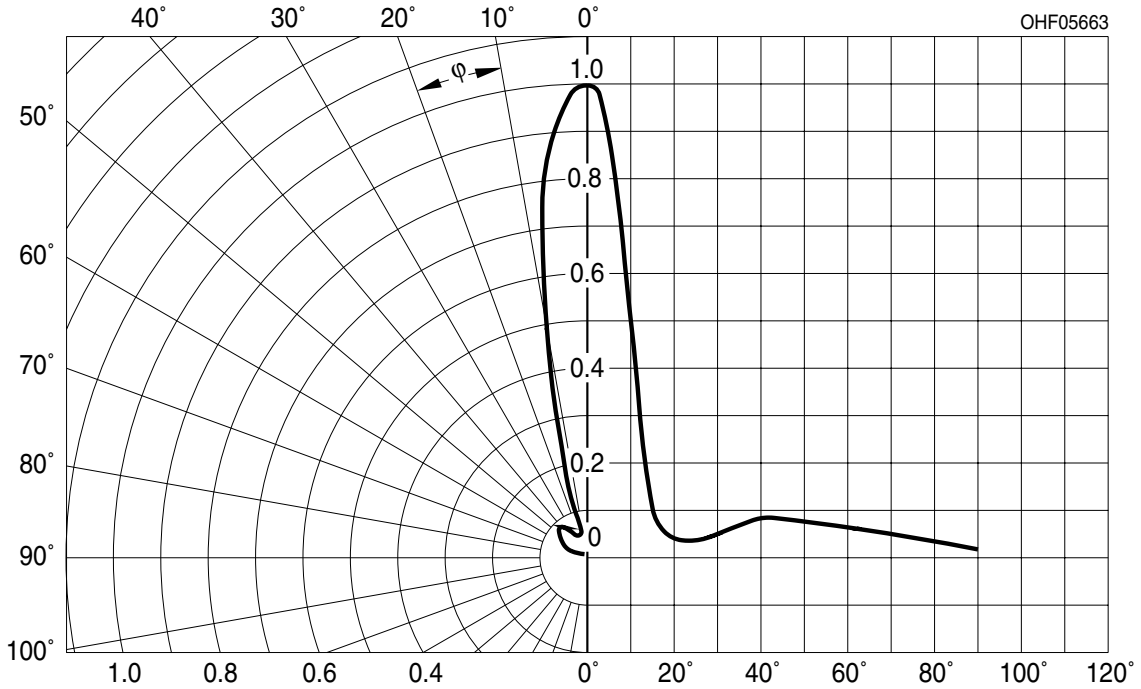

Discontinued

**Forward current** 8), 9)

$I_F = f(V_F)$ ; single pulse;  $t_p = 40 \mu s$

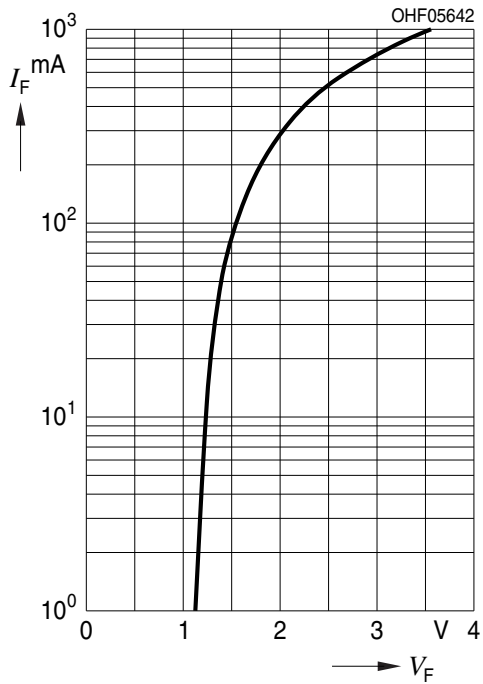

**Relative Radiant Intensity** 8), 9)

$I_e/I_e(40mA) = f(I_F)$ ; single pulse;  $t_p = 40 \mu s$

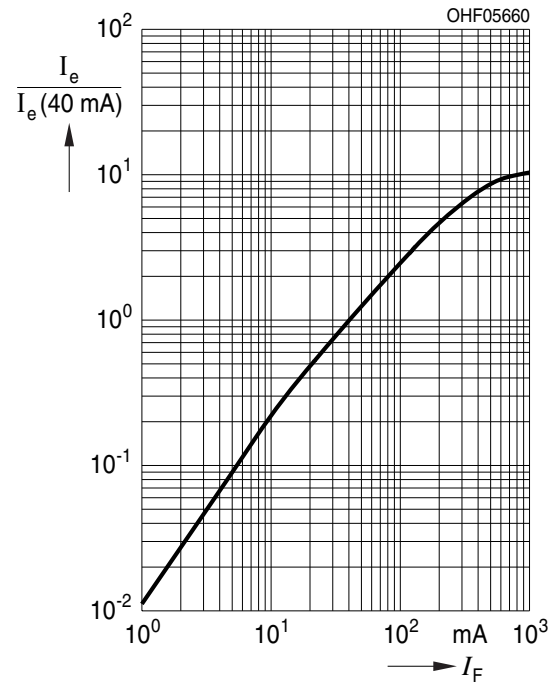

**Max. Permissible Forward Current**

$I_F = f(T_A)$ ;  $R_{th_{ja}} = 750 K / W$

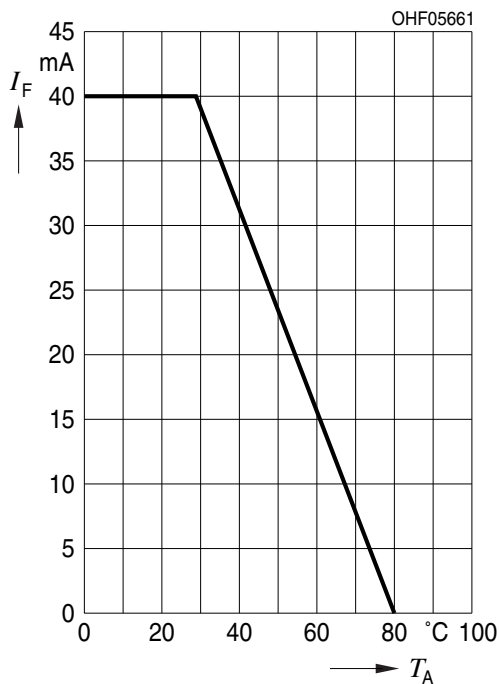

**Permissible Pulse Handling Capability**

$I_F = f(t_p)$ ; duty cycle  $D = \text{parameter}$ ;  $T_A = 25^\circ C$

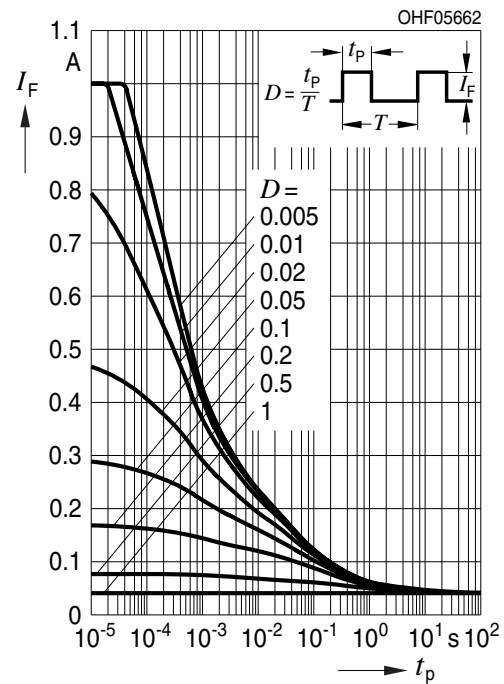

Discontinued

Dimensional Drawing <sup>10)</sup>

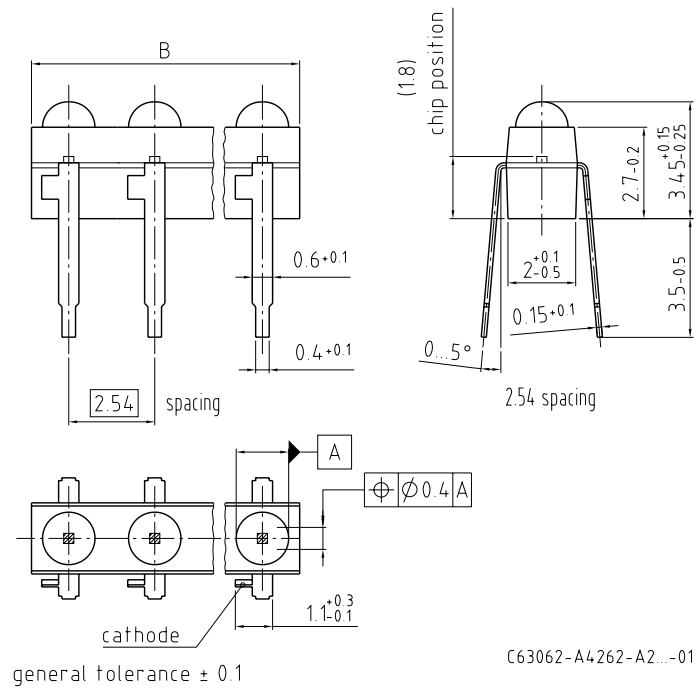

Further Information:

Approximate Weight: 54.0 mg

Package marking: Cathode



### Recommended Solder Pad <sup>10)</sup>

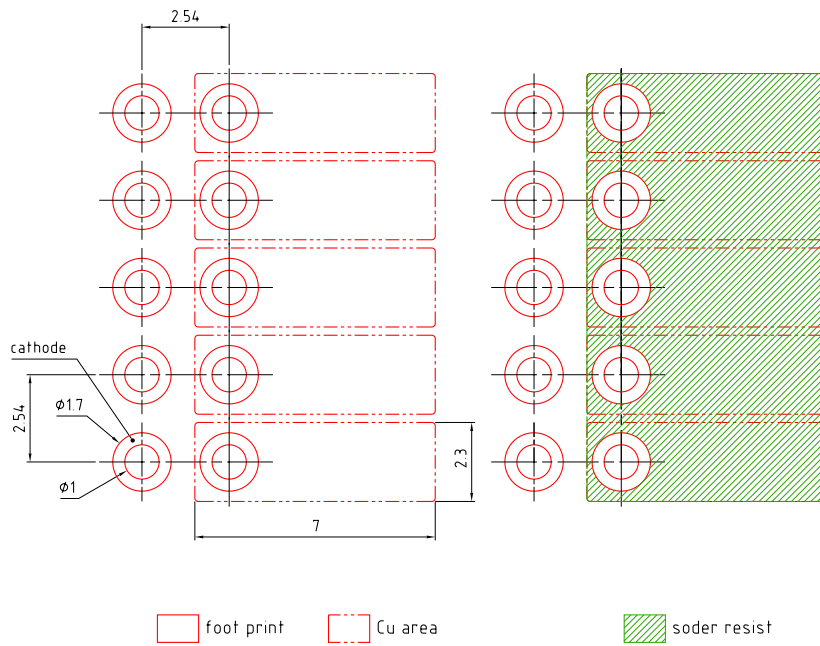

E062 3010 190-01

## TTW Soldering

IEC-61760-1 TTW

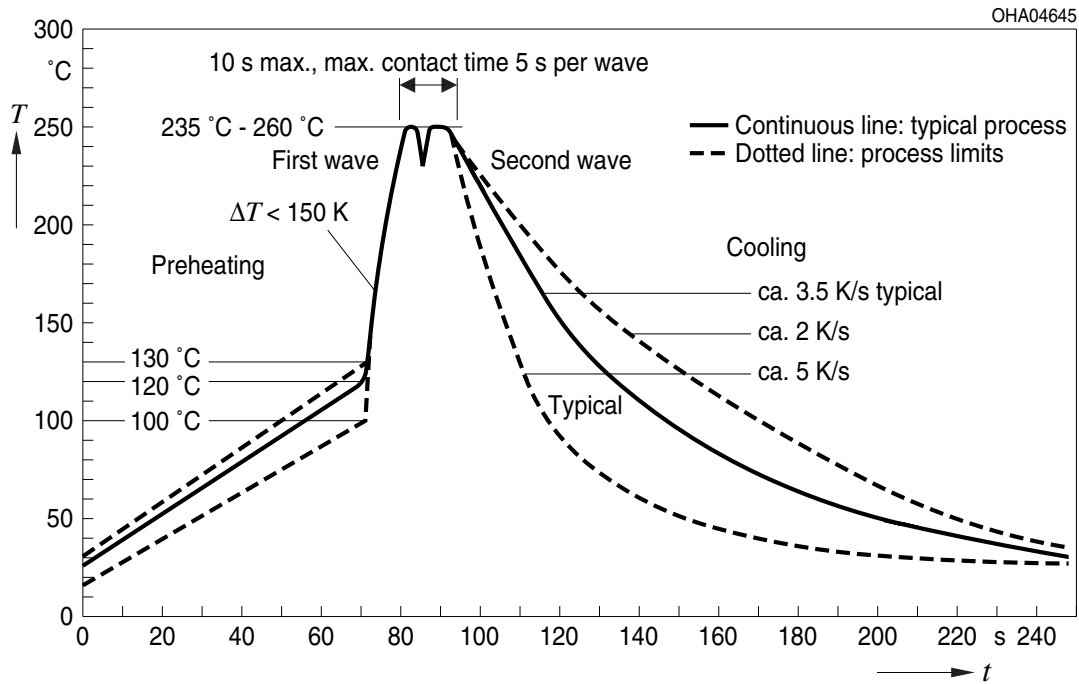

### Notes

The evaluation of eye safety occurs according to the standard IEC 62471:2006 (photo biological safety of lamps and lamp systems). Within the risk grouping system of this IEC standard, the device specified in this data sheet fall into the class **exempt group (exposure time 10000 s)**. Under real circumstances (for exposure time, conditions of the eye pupils, observation distance), it is assumed that no endangerment to the eye exists from these devices. As a matter of principle, however, it should be mentioned that intense light sources have a high secondary exposure potential due to their blinding effect. When looking at bright light sources (e.g. headlights), temporary reduction in visual acuity and afterimages can occur, leading to irritation, annoyance, visual impairment, and even accidents, depending on the situation.

Subcomponents of this device contain, in addition to other substances, metal filled materials including silver. Metal filled materials can be affected by environments that contain traces of aggressive substances. Therefore, we recommend that customers minimize device exposure to aggressive substances during storage, production, and use. Devices that showed visible discoloration when tested using the described tests above did show no performance deviations within failure limits during the stated test duration. Respective failure limits are described in the IEC60810.

For further application related information please visit <https://ams-osram.com/support/application-notes>

---

## Disclaimer

### Attention please!

The information describes the type of component and shall not be considered as assured characteristics. Terms of delivery and rights to change design reserved. Due to technical requirements components may contain dangerous substances.

For information on the types in question please contact our Sales Organization.

If printed or downloaded, please find the latest version on our website.

### Packing

Please use the recycling operators known to you. We can also help you – get in touch with your nearest sales office. By agreement we will take packing material back, if it is sorted. You must bear the costs of transport. For packing material that is returned to us unsorted or which we are not obliged to accept, we shall have to invoice you for any costs incurred.

### Product and functional safety devices/applications or medical devices/applications

Our components are not developed, constructed or tested for the application as safety relevant component or for the application in medical devices.

Our products are not qualified at module and system level for such application.

In case buyer – or customer supplied by buyer – considers using our components in product safety devices/ applications or medical devices/applications, buyer and/or customer has to inform our local sales partner immediately and we and buyer and /or customer will analyze and coordinate the customer-specific request between us and buyer and/or customer.

## Glossary

- 1) **Radiant intensity:** Measured at a solid angle of  $\Omega = 0.001$  sr
- 2) **Brightness:** The brightness values are measured with a tolerance of  $\pm 11\%$ .
- 3) **Reverse Operation:** This product is intended to be operated applying a forward current within the specified range. Applying any continuous reverse bias or forward bias below the voltage range of light emission shall be avoided because it may cause migration which can change the electro-optical characteristics or damage the LED.
- 4) **Forward Voltage:** The forward voltages are measured with a tolerance of  $\pm 0.1$  V.
- 5) **Total radiant flux:** Measured with integrating sphere.
- 6) **Thermal resistance:** junction - soldering point, of the device only, mounted on an ideal heatsink (e.g. metal block)
- 7) **Thermal resistance:** junction - ambient, mounted on PC-board (FR4), pads size 16 mm<sup>2</sup> each
- 8) **Typical Values:** Due to the special conditions of the manufacturing processes of semiconductor devices, the typical data or calculated correlations of technical parameters can only reflect statistical figures. These do not necessarily correspond to the actual parameters of each single product, which could differ from the typical data and calculated correlations or the typical characteristic line. If requested, e.g. because of technical improvements, these typ. data will be changed without any further notice.
- 9) **Testing temperature:** TA = 25°C (unless otherwise specified)
- 10) **Tolerance of Measure:** Unless otherwise noted in drawing, tolerances are specified with  $\pm 0.1$  and dimensions are specified in mm.

---

## Revision History

Version	Date	Change
1.3	2023-06-06	New Layout Applications Discontinued

---

Discontinued

---



EU RoHS and China RoHS compliant product

此产品符合欧盟 RoHS 指令的要求；  
按照中国的相关法规和标准，  
不含有毒有害物质或元素。

**Published by ams-OSRAM AG**

Tobelbader Strasse 30, 8141 Premstaetten, Austria

Phone +43 3136 500-0

[ams-osram.com](http://ams-osram.com)

© All rights reserved

**am** 

**OSRAM**