



GENERAL SPECIFICATIONS (电气特性)

1. Series model: (系列号)	SMD3068
2. Normal Frequency: (标称频率)	32.768000KHz
3. Oscillation Mode: (振动模式)	<input checked="" type="checkbox"/> Fundamental <input type="checkbox"/> 3rd
4. Load Capacitance(CL): (负载电容)	12.5 PF
5. Frequency Tolerance 25±3℃: (频率偏差 25±3℃)	±10PPM
6. Stability Over Temperature Range: (工作温度频率偏差)	±30 PPM at -40℃ to+85℃
7. Effective Series Resistance: (等效电阻)	≤ 70 KΩ
8. Shunt Capacitance(C0): (静态电容)	≤ 3 PF
9. Typical drive level: (激励功率)	10uW TYP.
10. Operation Temperature Range: (工作温度范围)	-40℃ to +85℃
11. Storage Temperature: (存储温度)	-55℃ to +125℃
12. Insulation Resistance: (绝缘阻抗)	≥500 MΩ at DC 100V
13. Aging: (老化率)	±3 PPM/Year
14. Leak (检漏)	1×10 ⁻⁷ Torr.1/sec Max
15. Test circuit (测试仪器)	S&A 250B Pi-Network Crystal Measurement System

Remark (备注):

晶振最佳储存条件: 温度: 25±5℃, 湿度: <70%。

密封包装, 切勿挤压, 切勿在 30cm 以上的高度滑落跌落。

DIMENSIONS SPECIFICATIONS (外形尺寸)

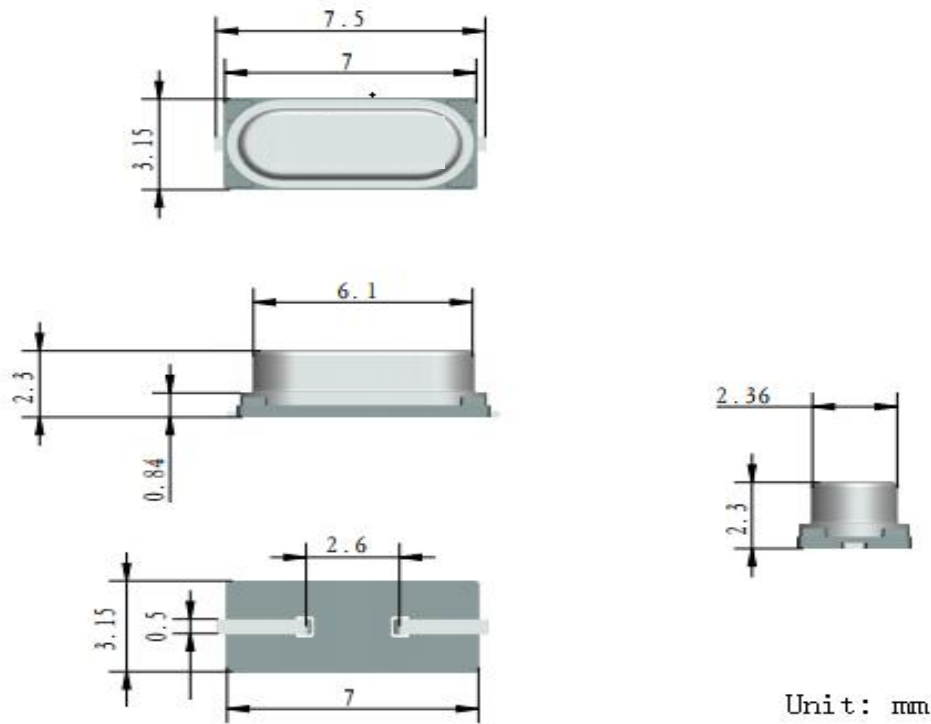

MARKING SPECIFICATION (印字)

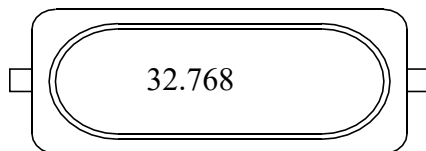

注意:

32.768 为额定频率 (KHz),



PACKING (包装)

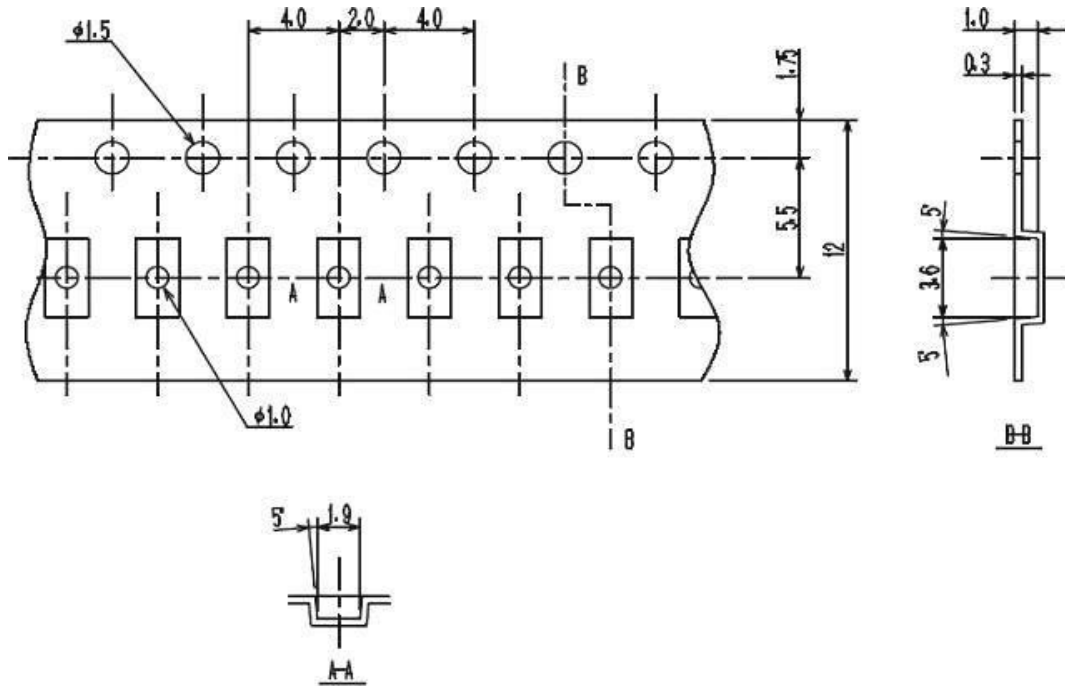

Reel Dimensions(unit: mm)

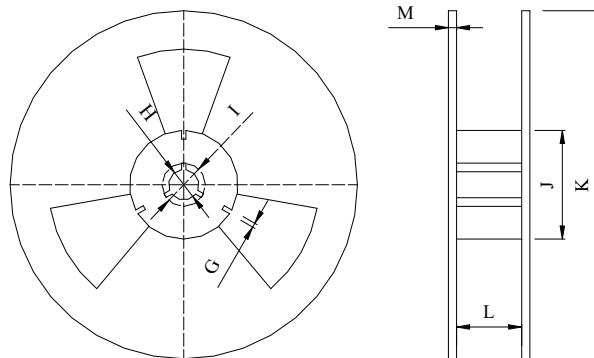

Unit : mm

Standard Reel Quantity is **3000 pcs** per Reel.