

MMBTRC401E...MMBTRC406E

NPN Silicon Epitaxial Planar Transistor

For switching and interface circuit and drive circuit applications

Features

- With built-in bias resistors
- Simplify circuit design
- Reduce a quantity of parts and manufacturing process

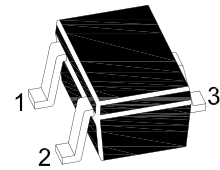
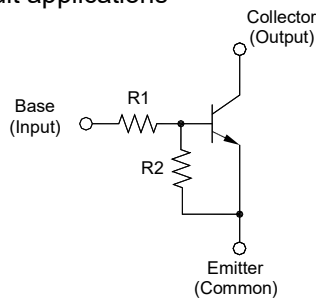

1.Base 2.Emitter 3.Collector
SOT-523 Plastic Package

Resistor Values

Type	R1 (K Ω)	R2 (K Ω)
MMBTRC401E	4.7	4.7
MMBTRC402E	10	10
MMBTRC403E	22	22
MMBTRC404E	47	47
MMBTRC405E	2.2	47
MMBTRC406E	4.7	47

Absolute Maximum Ratings ($T_a = 25^\circ\text{C}$)

Parameter	Symbol	Value	Unit
Output Voltage	V_{CBO}	50	V
Input Voltage	V_{EBO}	20, -10	V
		30, -10	
		40, -10	
		40, -10	
		12, -5	
		20, -5	
Output Current	I_c	100	mA
Total Power Dissipation	P_{tot}	100	mW
Junction Temperature	T_j	150	$^\circ\text{C}$
Storage Temperature Range	T_{stg}	- 55 to + 150	$^\circ\text{C}$

Thermal Characteristics

Parameter	Symbol	Max.	Unit
Thermal Resistance from Junction to Ambient ¹⁾	$R_{\theta JA}$	1250	$^\circ\text{C/W}$

¹⁾ Device mounted on FR-4 substrate PC board, 2oz copper, with minimum recommended pad layout.

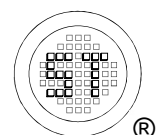

MMBTRC401E...MMBTRC406E

Characteristics at $T_a = 25^\circ\text{C}$

Parameter	Symbol	Min.	Typ.	Max.	Unit
DC Current Gain at $V_{CE} = 5\text{ V}$, $I_C = 10\text{ mA}$	MMBTRC401E	30	-	-	-
	MMBTRC402E	50	-	-	-
	MMBTRC403E	70	-	-	-
	MMBTRC404E	80	-	-	-
	MMBTRC405E	80	-	-	-
	MMBTRC406E	80	-	-	-
Output Cutoff Current at $V_{CE} = 50\text{ V}$	I_{CEO}	-	-	500	nA
Input Current at $V_{EB} = 5\text{ V}$	MMBTRC401E	-	-	1.8	mA
	MMBTRC402E	-	-	0.88	
	MMBTRC403E	-	-	0.36	
	MMBTRC404E	-	-	0.18	
	MMBTRC405E	-	-	3.6	
	MMBTRC406E	-	-	1.8	
Output Voltage at $I_C = 10\text{ mA}$, $I_B = 0.5\text{ mA}$	$V_{CE(SAT)}$	-	-	0.3	V
Input Voltage (ON) at $V_{CE} = 0.2\text{ V}$, $I_C = 5\text{ mA}$	MMBTRC401E	-	-	2	V
	MMBTRC402E	-	-	2.4	
	MMBTRC403E	-	-	3	
	MMBTRC404E	-	-	5	
	MMBTRC405E	-	-	1.1	
	MMBTRC406E	-	-	1.3	
Input Voltage (OFF) at $V_{CE} = 5\text{ V}$, $I_C = 0.1\text{ mA}$	MMBTRC401E~404E	1	-	-	V
	MMBTRC405E~406E	0.5	-	-	
Transition Frequency at $V_{CE} = 10\text{ V}$, $I_C = 5\text{ mA}$	$f_T^{1)}$	-	200	-	MHz

¹⁾ Characteristic of transistor only.

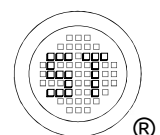

MMBTRC401E...MMBTRC406E

Electrical Characteristics Curves: MMBTRC401E

Fig 1. Collector Current vs. $V_{I(ON)}$

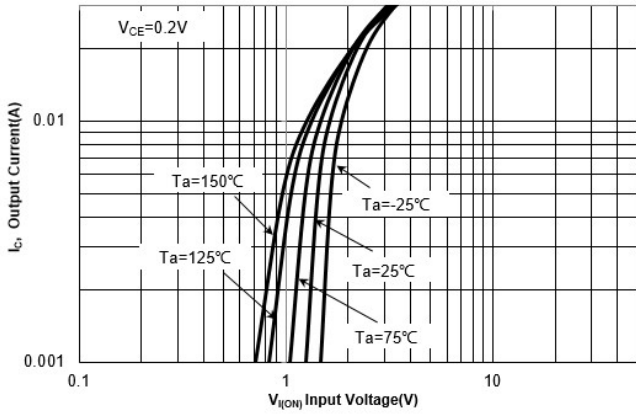

Fig 2. Collector Current vs. $V_{I(off)}$

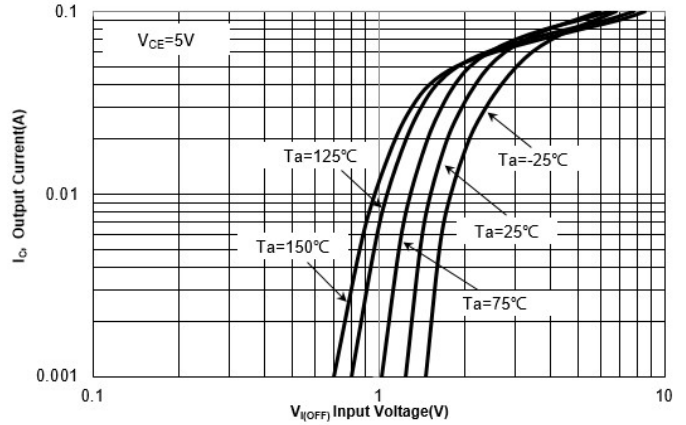

Fig 3. DC Current Gain vs. Collector Current

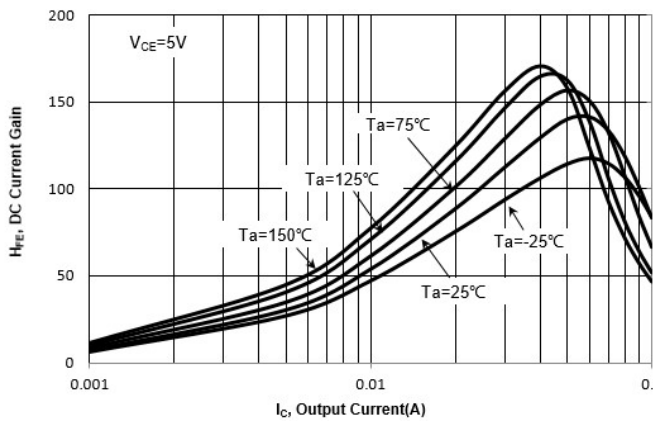
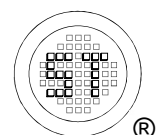
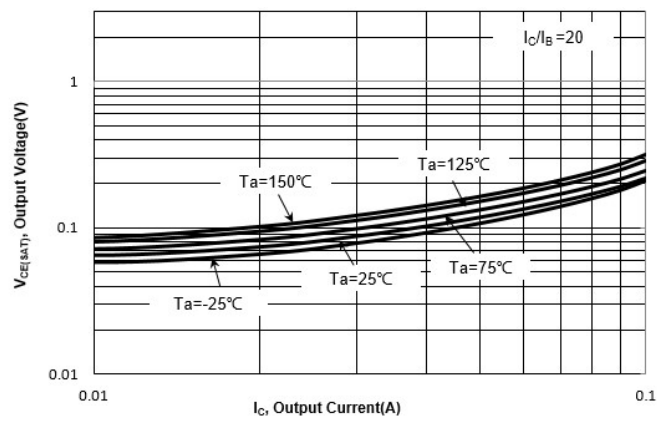

Fig 4. $V_{CE(sat)}$ vs. Collector Current



MMBTRC401E...MMBTRC406E

Electrical Characteristics Curves: MMBTRC402E

Fig 1. Collector Current vs. $V_{I(ON)}$

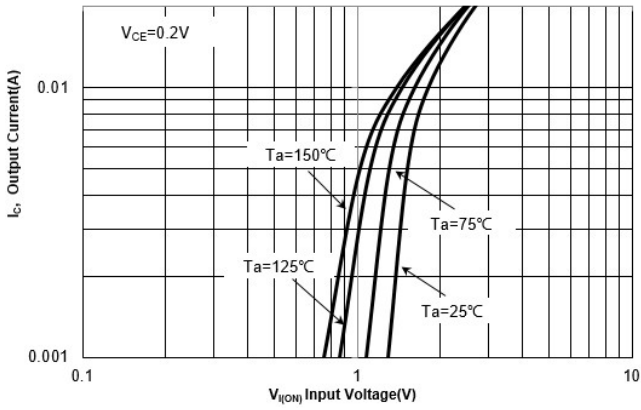

Fig 2. Collector Current vs. $V_{I(OFF)}$

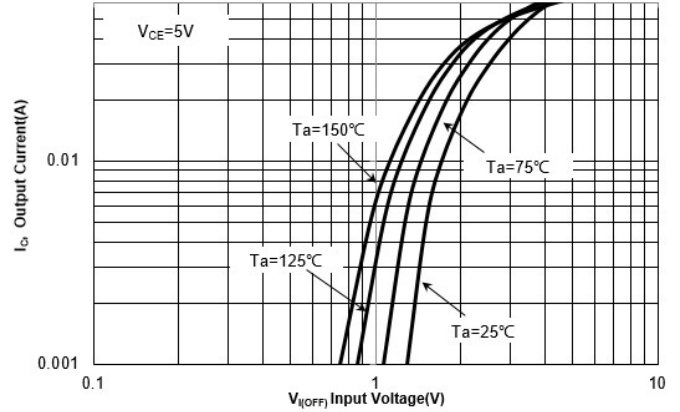

Fig 3. DC Current Gain vs. Collector Current

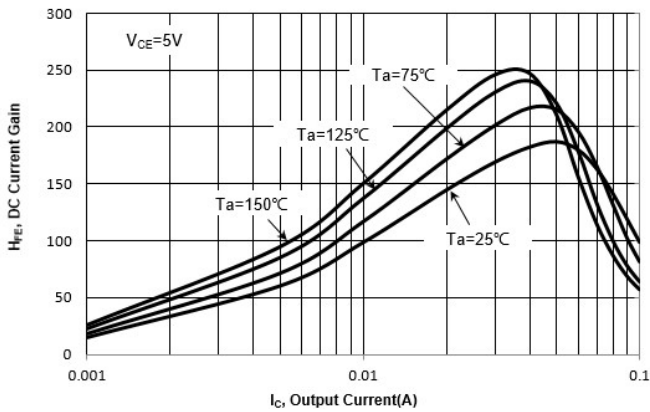
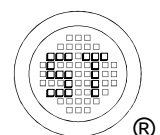
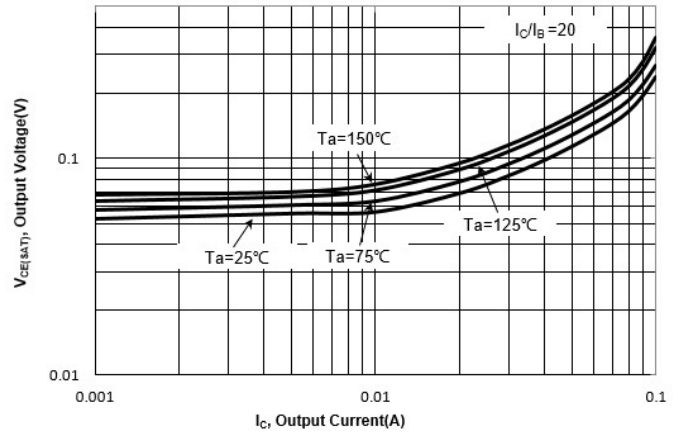

Fig 4. $V_{CE(sat)}$ vs. Collector Current



MMBTRC401E...MMBTRC406E

Electrical Characteristics Curves: MMBTRC403E

Fig 1. Collector Current vs. $V_{I(ON)}$

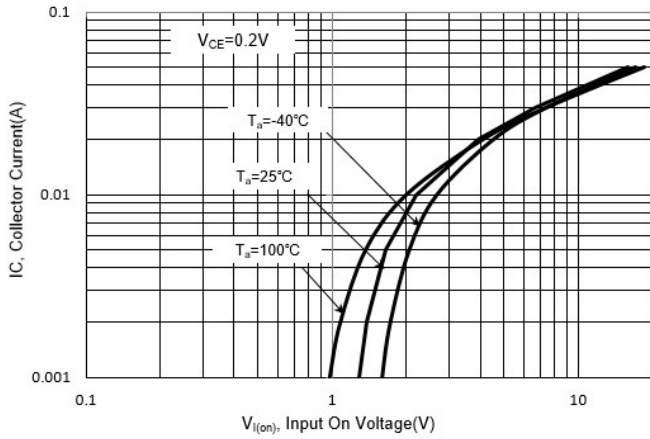

Fig 2. Collector Current vs. $V_{I(off)}$

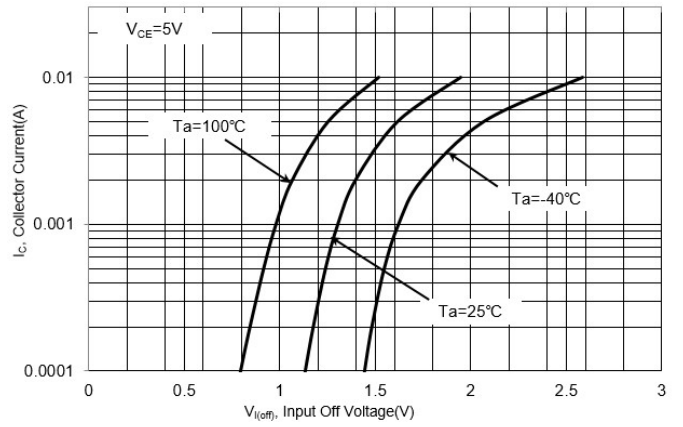

Fig 3. DC Current Gain vs. Collector Current

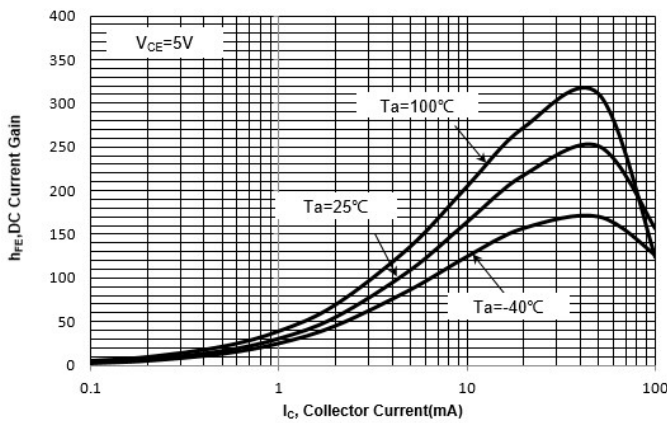
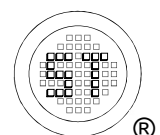
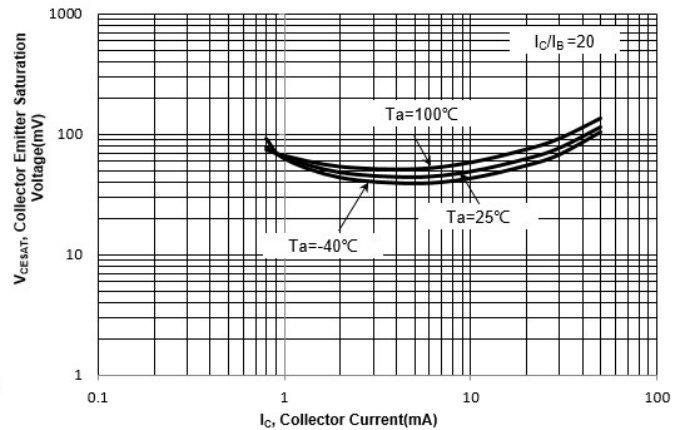

Fig 4. $V_{CE(sat)}$ vs. Collector Current



MMBTRC401E...MMBTRC406E

Electrical Characteristics Curves: MMBTRC404E

Fig 1. Collector Current vs. $V_{I(ON)}$

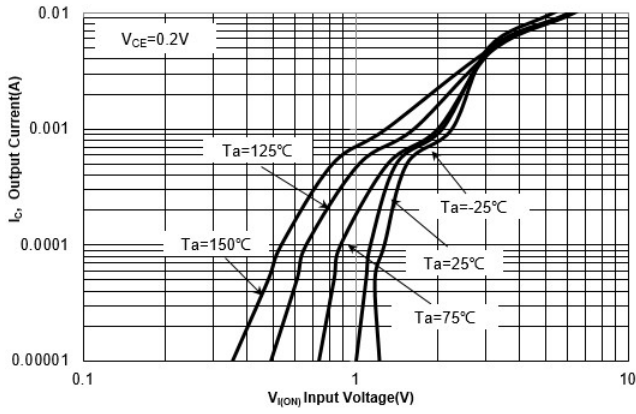

Fig 2. Collector Current vs. $V_{I(OFF)}$

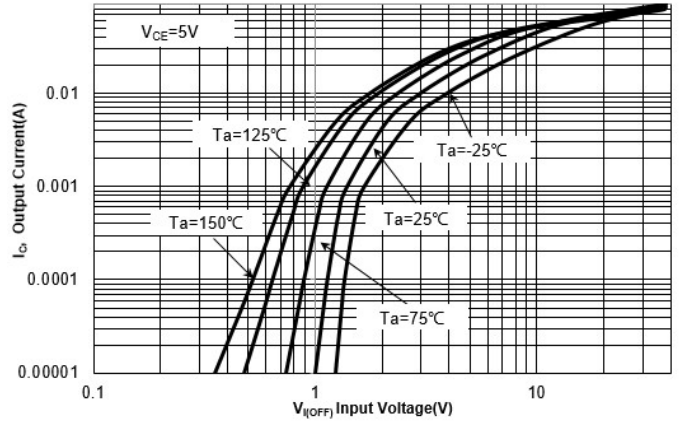

Fig 3. DC Current Gain vs. Collector Current

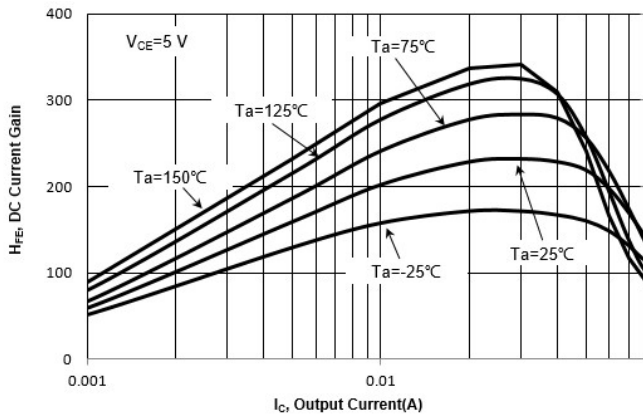
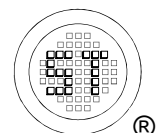
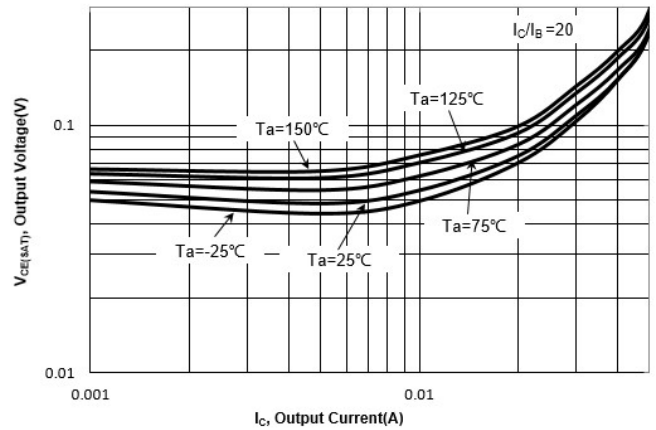

Fig 4. $V_{CE(sat)}$ vs. Collector Current



MMBTRC401E...MMBTRC406E

Electrical Characteristics Curves: MMBTRC405E

Fig 1. Collector Current vs. $V_{I(on)}$

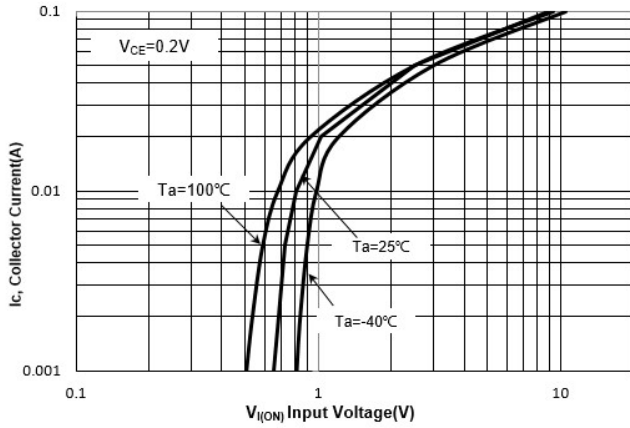

Fig 2. Collector Current vs. $V_{I(off)}$

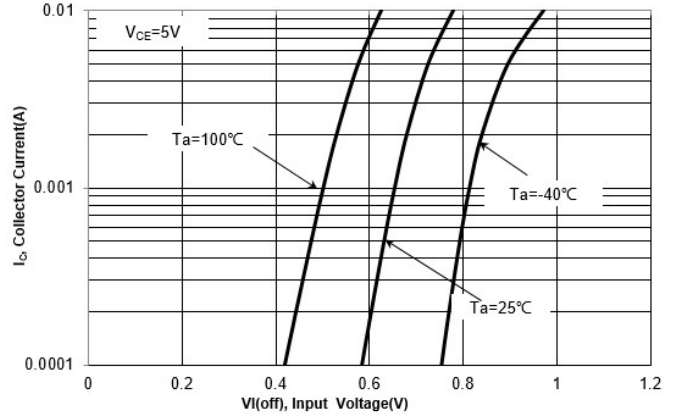

Fig 3. DC Current Gain vs. Collector Current

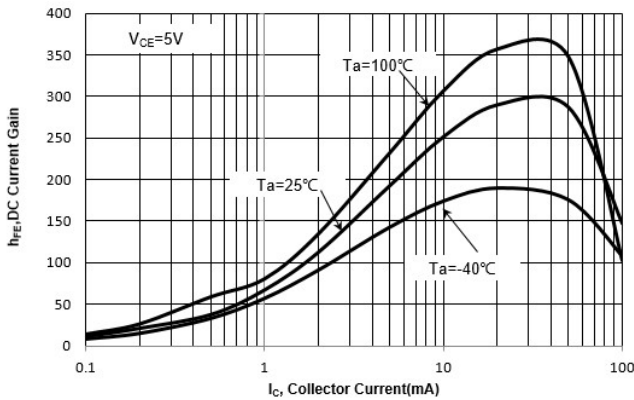
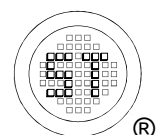
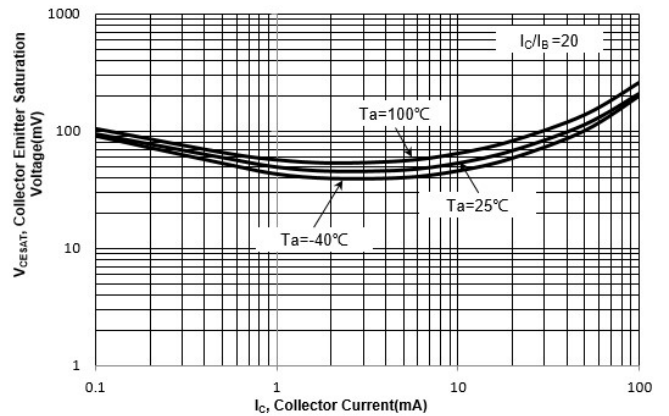

Fig 4. $V_{CE(sat)}$ vs. Collector Current



MMBTRC401E...MMBTRC406E

Electrical Characteristics Curves: MMBTRC406E

Fig 1. Collector Current vs. $V_{I(ON)}$

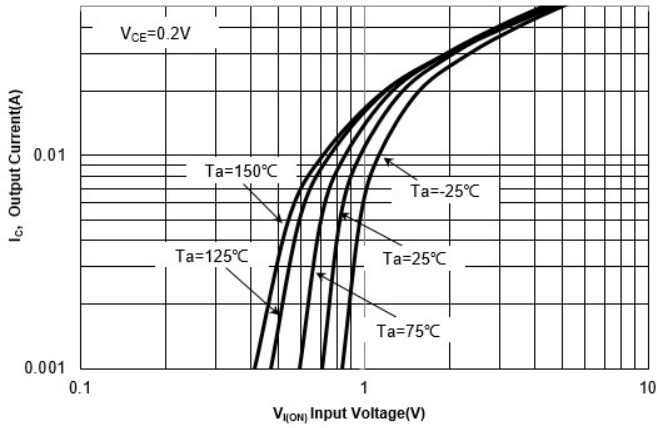

Fig 2. Collector Current vs. $V_{I(OFF)}$

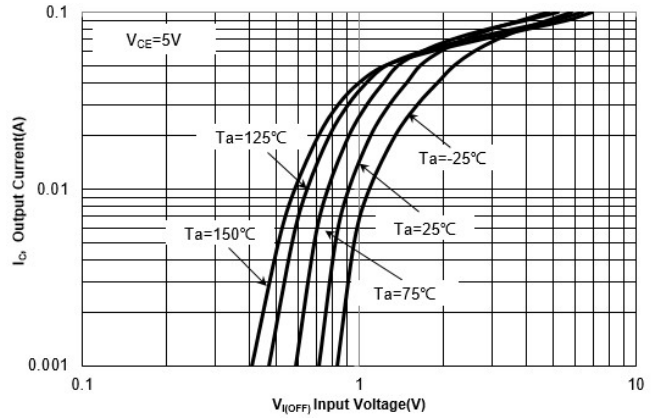

Fig 3. DC Current Gain vs. Collector Current

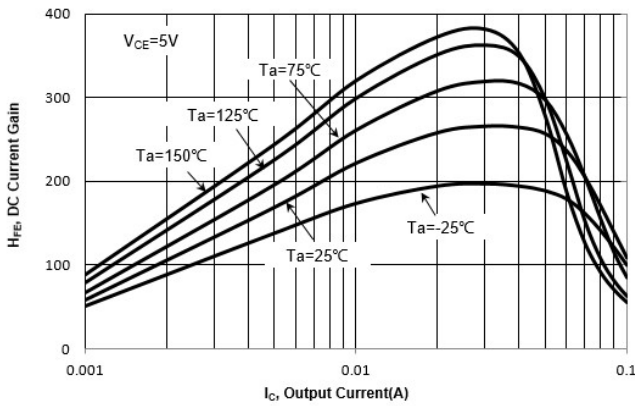
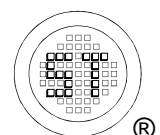
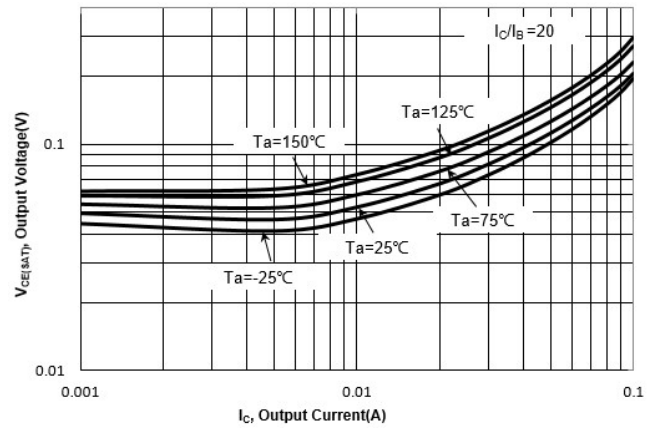

Fig 4. $V_{CE(sat)}$ vs. Collector Current



MMBTRC401E...MMBTRC406E

Package Outline (Dimensions in mm)

SOT-523

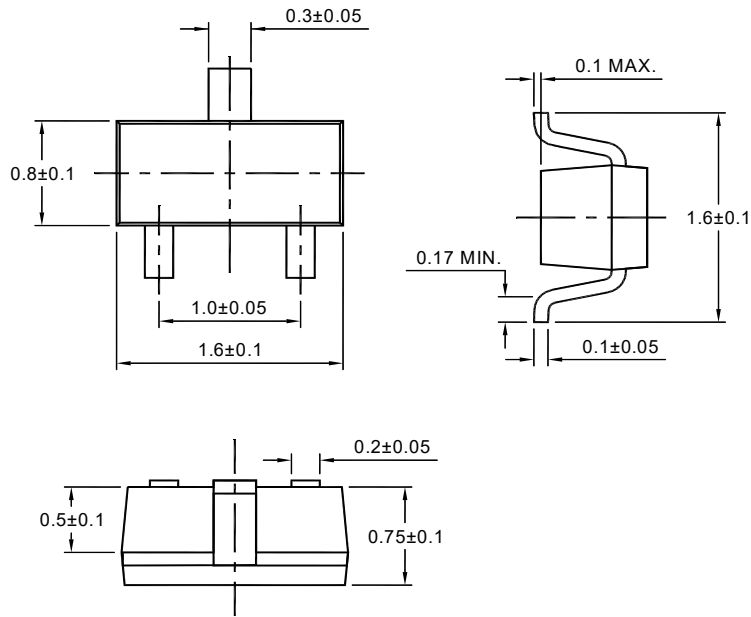

Recommended Soldering Footprint

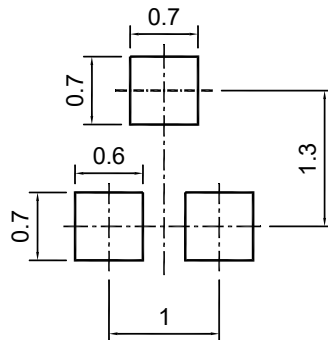

Packing information

Package	Tape Width (mm)	Pitch		Reel Size		Per Reel Packing Quantity
		mm	inch	mm	inch	
SOT-523	8	4 ± 0.1	0.157 ± 0.004	178	7	4,000

Marking information

"**" = Part No.

Type	Marking	Type	Marking	Type	Marking
MMBTRC401E	RH	MMBTRC403E	RK	MMBTRC405E	RM
MMBTRC402E	RJ	MMBTRC404E	RL	MMBTRC406E	RN

"YM" = Date Code Marking

"Y" = Year

"M" = Month

Font type: Arial

