

0.7uA Ultra-Low Iq, 150mA LDO in DFN1x1 and SOT23-5

DESCRIPTION

ETA5070 is a fixed output, low-dropout (LDO) low-power linear voltage regulator that features ultra-low standby current as low as 0.7uA. It can withstand input voltage up to 7V and delivery at least 150mA at output. Therefore, ETA5070 is an ideal power supply for low power applications such as IoT, wearables and other battery powered system, and etc.

ETA5070 is available in DFN1x1 and SOT23-5.

FEATURES

- ◆ 0.7uA ultra-low Iq
- ◆ 7V input voltage
- ◆ 150mA output current
- ◆ Stable with a Wide Range of Ceramic Capacitor
- ◆ 0.34V dropout voltage for 100mA at Vout=2.8V

APPLICATIONS

- ◆ NB-IoT module
- ◆ Wearables
- ◆ Fingerprint lock

TYPICAL APPLICATION

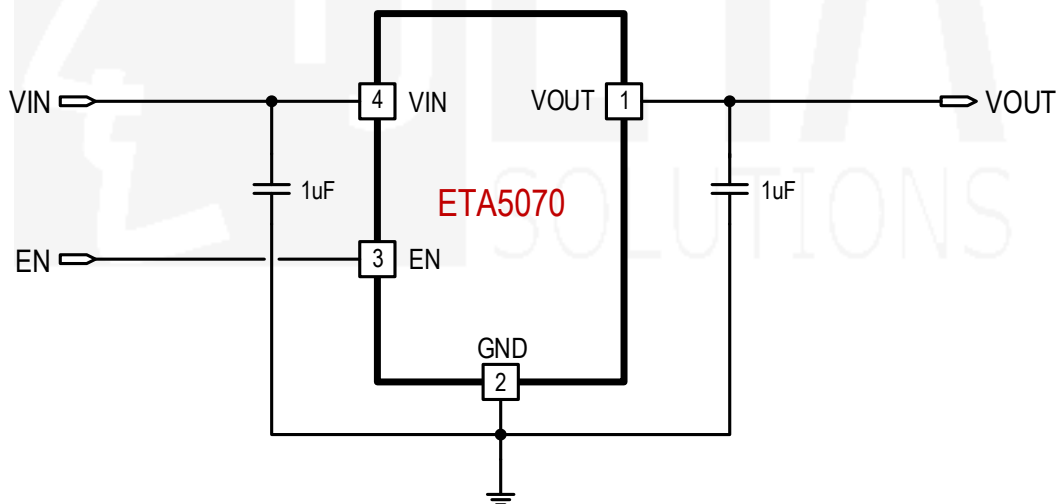

ORDERING

INFORMATION

PART No.	PACKAGE	TOP MARK	Pcs/Reel
ETA5070VXXXOS2F	SOT23-5	PPYW	3000
ETA5070VXXXOF1E	DFN1x1-4	PP YW	10000
XXX: voltage code Q=N: no discharge;	e.g. 120=1.2V Q=D: discharge	PP: product code YW: date code	

PIN CONFIGURATION

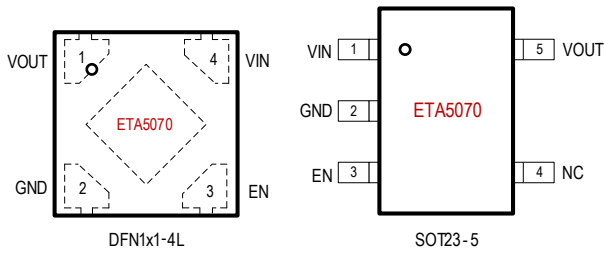

ABSOLUTE MAXIMUM RATINGS

(Note: Exceeding these limits may damage the device. Exposure to absolute maximum rating conditions for long periods may affect device reliability.)

VIN, EN, VOUT Voltage	-0.3V to 7V
Operating Temperature Range.....	-40°C to 85°C
Storage Temperature Range	-55°C to 150°C
Thermal Resistance θ_{JA} θ_{JC}	
SOT23-5.....	180.....90..... °C/W
DFN1x1-4L.....	120.....60..... °C/W
Lead Temperature (Soldering 10sec)	260°C
ESD HBM (Human Body Mode).....	2KV
ESD MM (Machine Mode).....	200V

ELECTRICAL CHARACTERISTICS

(VIN = 3.8V, VOUT = 2.8V, unless otherwise specified. Typical values are at TA = 25°C.)

PARAMETER	CONDITIONS	MIN	TYP	MAX	UNIT
Input Voltage Range ⁽¹⁾		2.2		7.0	V
Ground Current	No Load		0.7		µA
Shutdown Current	V _{EN} = 0V, 1.8V ≤ VIN ≤ 5.5V			0.1	µA
Dropout Voltage	I _{OUT} = 100mA		0.34		V
Continuous Output Current				300	mA
Output Current Limit	V _{OUT} = 95%	350	500		mA
Output Foldback Current Limit	V _{OUT} = 0V		120		mA
Line Regulation	V _{OUT} + 1V ≤ VIN ≤ 5.5V			0.12	%/V
Load Regulation	0µA ≤ I _{OUT} ≤ 200 mA		20		mV
Output Voltage Range	Available in 100mV steps	1.2		3.6	V
Vout Voltage accuracy	I _{OUT} = 30mA, V _{out} > 1.8V	-2		+2	%
Power Supply Rejection Ratio	Freq = 100Hz, I _{OUT} = 30mA		60		dB
	Freq = 1kHz, I _{OUT} = 30mA		57.6		
Start-up time			300		µs
EN pin input Logic Low	1.8V ≤ VIN ≤ 5.5V			0.4	V
EN pin input Logic High	1.8V ≤ VIN ≤ 5.5V	1.2			V
Input current at EN pin	V _{EN} = 3V		0		µA
Thermal Shutdown	Rising, Hysteresis = 30°C		170		°C

(1): Minimum V_{IN} is V_{OUT} + V_{DROPOUT}, whichever is greater.

PIN DESCRIPTION

DFN1x1-4L PIN #	SOT23-5 PIN#	NAME	DESCRIPTION
1	5	VOUT	Output of regulator
2	2	GND	Ground Pin
3	3	EN	Enable Pin. Drive it high to enable IC, drive it low to disable. EN can be connected to IN if not used.
4	1	VIN	Input Supply Pin
	4	NC	Not Connected

TYPICAL CHARACTERISTICS

(Typical values are at $T_A = 25^\circ\text{C}$ unless otherwise specified.)

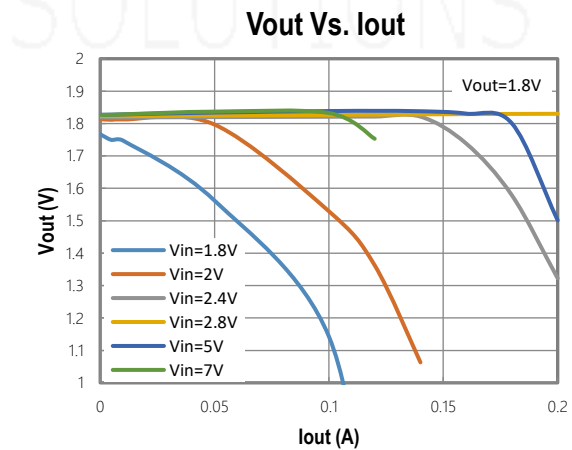
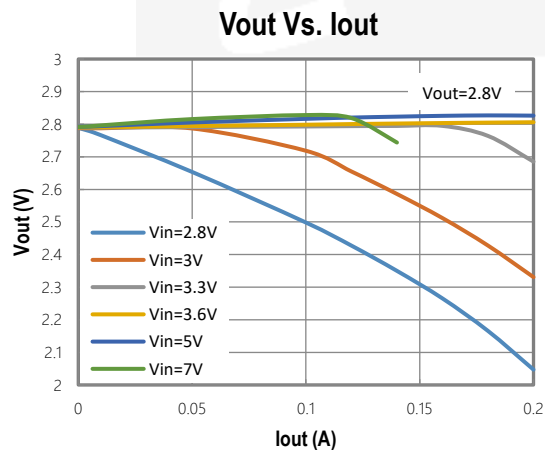
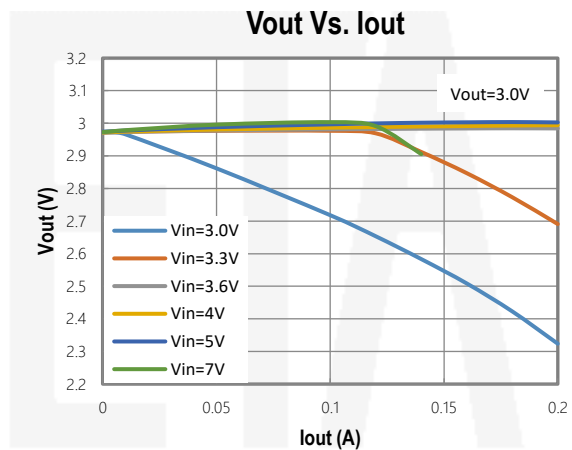
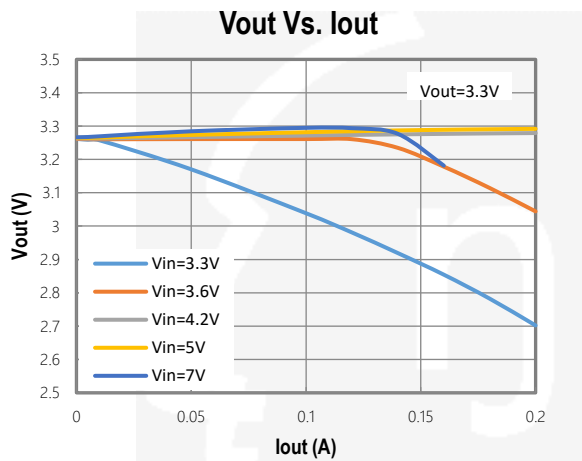

TYPICAL CHARACTERISTICS (cont')

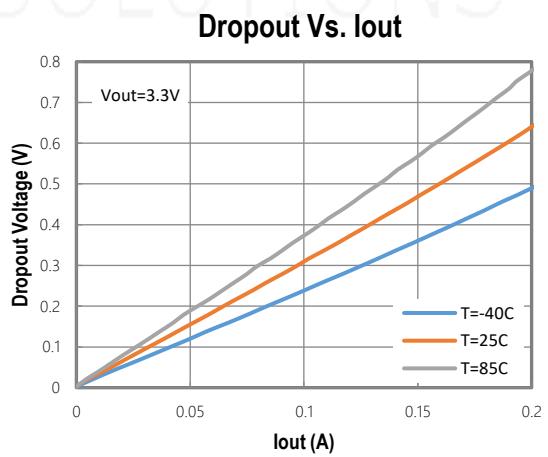
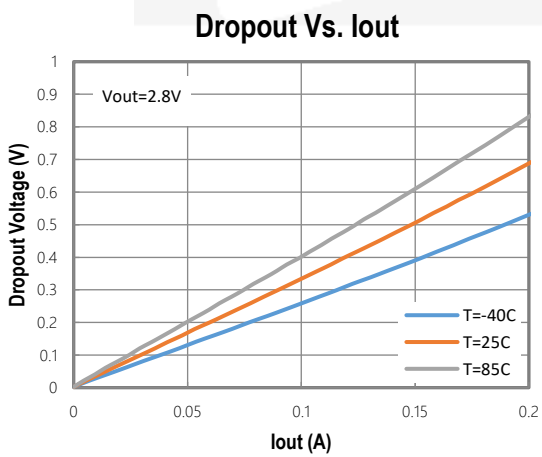
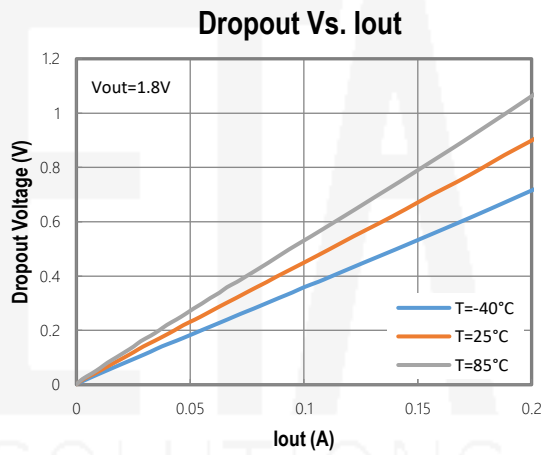
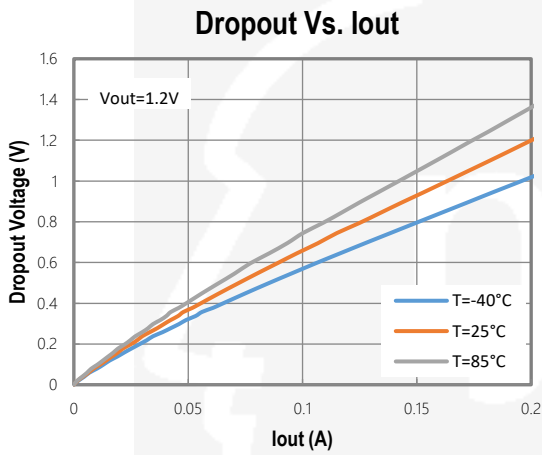
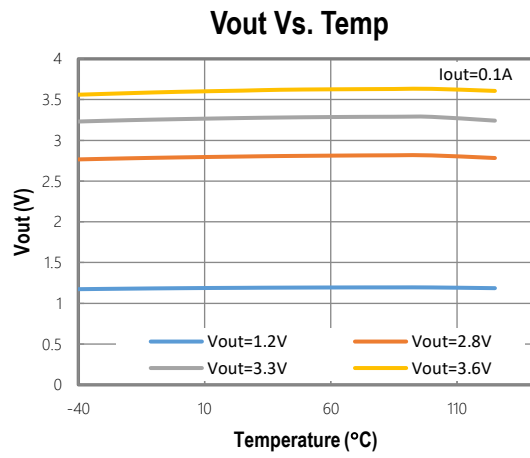
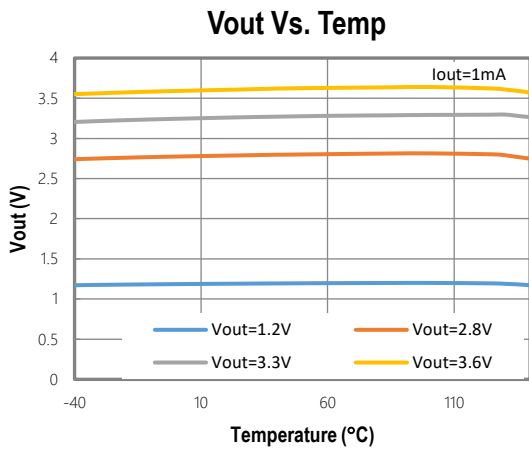

TYPICAL CHARACTERISTICS (cont')

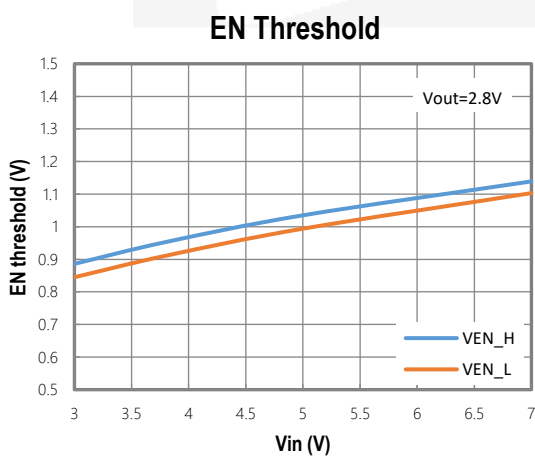
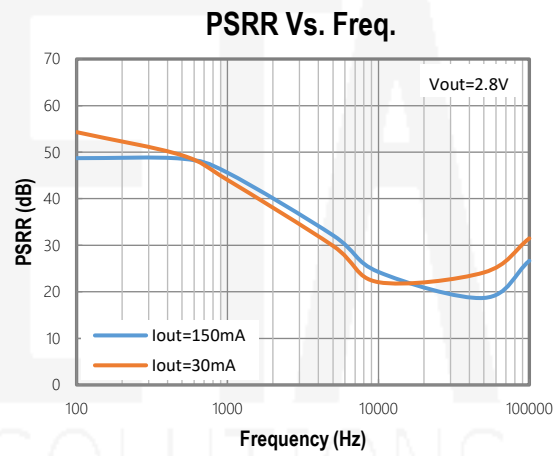
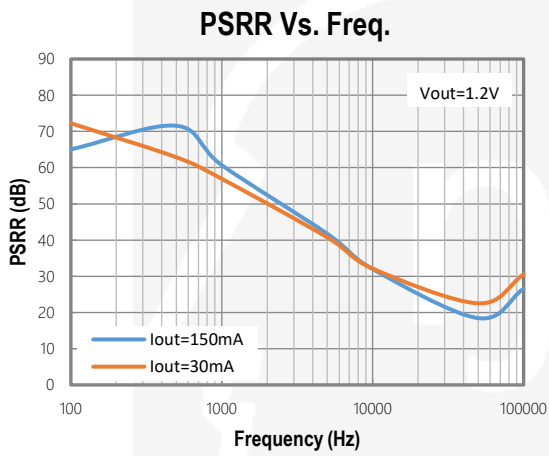
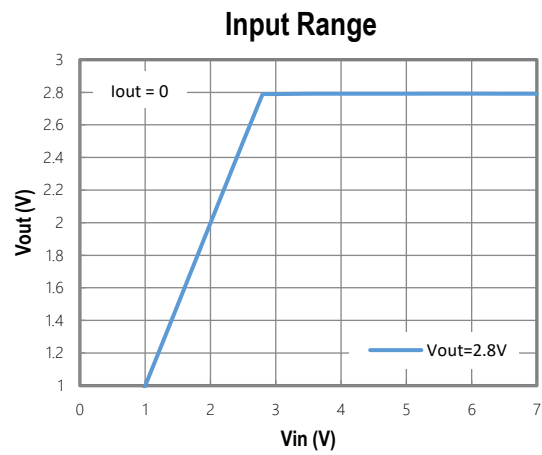
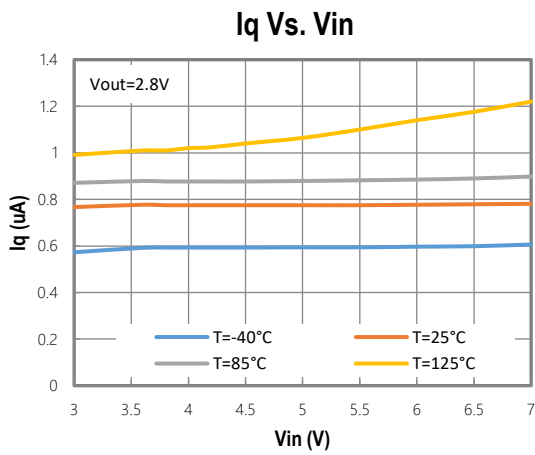

Load Transient Response

Vin=3.8V, Vout=2.8V, Iout=0.05-0.1A

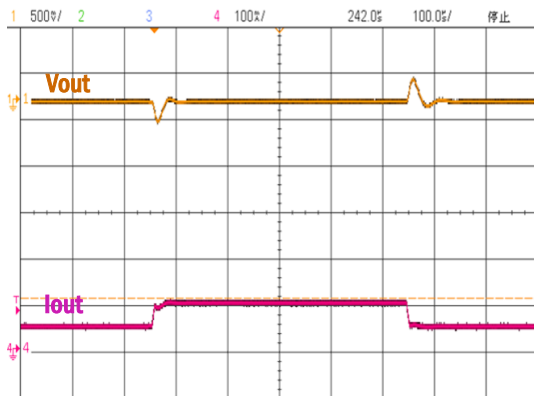

Startup Waveforms

Vin=3.8V, Vout=2.8V, Iout=100mA

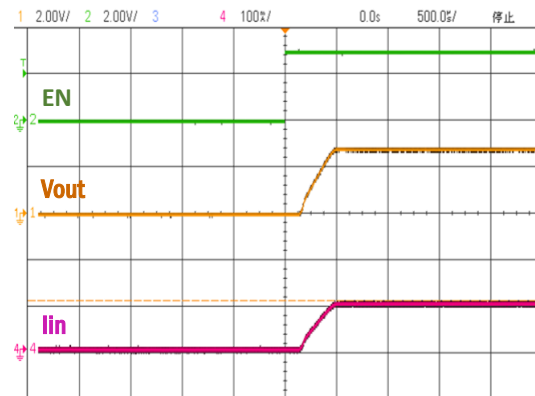

FUNCTIONAL BLOCK DIAGRAM

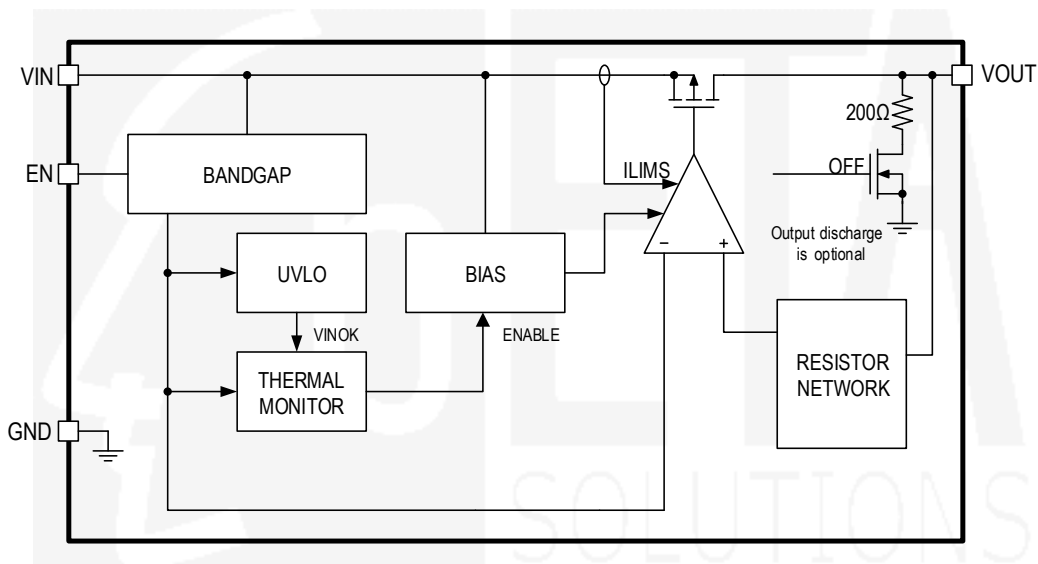

FUNCTIONAL DESCRIPTION

The ETA5070 family of LDO regulators has been optimized for application in low standby power equipment. The device features ultra-low quiescent current, and 7V input current with 150mA output current capability.

Enable Sequence

ETA5070 is enabled when all below conditions happen. Otherwise, ETA5070 is in standby mode.

- ◆ EN pin voltage above Logic High level
- ◆ Junction Temperature is not at Over-Temperature Protection level.

Once all above conditions happen, ETA5070 first enables BANDGAP and BIAS then enables LDO core.

ETA5070 is completed forced in shutdown mode when EN pin is at below LOGIC_LOW that supply current is less than 0.01μA. Otherwise, part only shutdown the VOUT while other circuit still in operation. Once ETA5070 is in shutdown conditions, Output is discharged by 200Ω resistor (optional).

Output Current Limit and Foldback Current Limit

ETA5070 family features an internal current limit. In normal operation, the ETA5070 limits output current to approximately 500mA. When current limiting engages, the output voltage scales back linearly until the over current condition ends.

In case output is in hard short conditions, ETA5070 also features an internal foldback limit that reduces the output current limit to a lower level, 120mA, then reduce power dissipation ratings of the package.

Over-Temperature Protection

Thermal protection disables the output when the junction temperature rises to approximately 170°C, allowing the device to cool down. When the junction temperature cools to approximately 140°C, the output circuitry is again enabled. Depending on power dissipation, thermal resistance, and ambient temperature, the thermal protection circuit may cycle on and off. This cycling limits regulator dissipation, protecting the device from damage as a result of overheating.

PACKAGE OUTLINE

Package: DFN1x1-4L

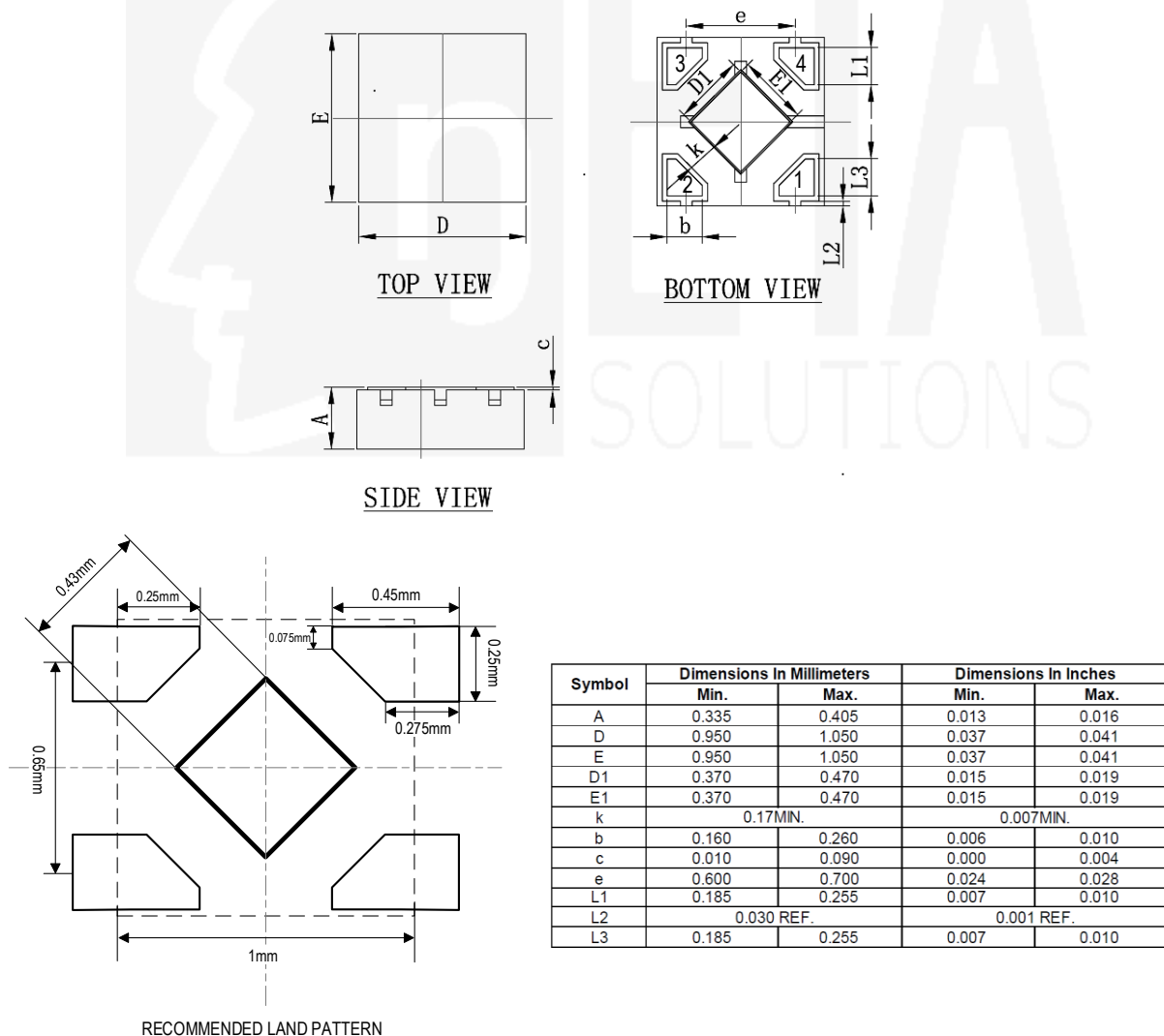

Package: SOT23-5

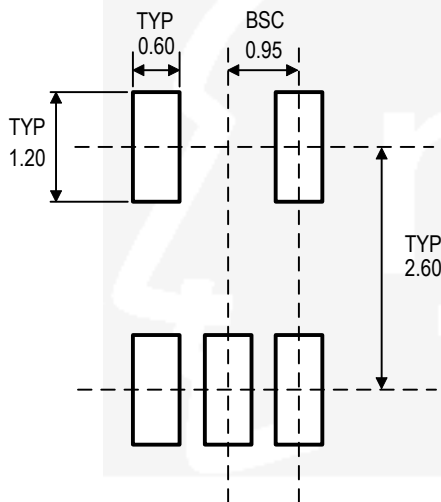
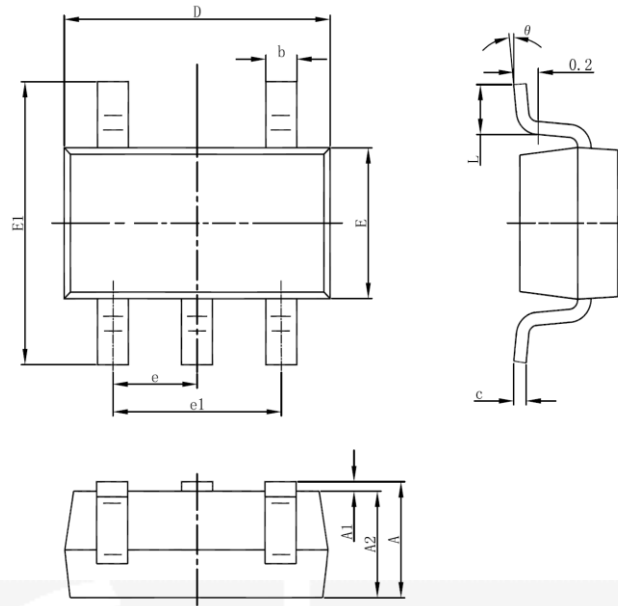

Symbol	Dimensions In Millimeters		Dimensions In Inches	
	Min	Max	Min	Max
A	1.050	1.250	0.041	0.049
A1	0.000	0.100	0.000	0.004
A2	1.050	1.150	0.041	0.045
b	0.300	0.500	0.012	0.020
c	0.100	0.200	0.004	0.008
D	2.820	3.020	0.111	0.119
E	1.500	1.700	0.059	0.067
E1	2.650	2.950	0.104	0.116
e	0.950(BSC)		0.037(BSC)	
e1	1.800	2.000	0.071	0.079
L	0.300	0.600	0.012	0.024
θ	0°	8°	0°	8°

RECOMMENDED LAND PATTERN

AVAILABLE PART NUMBER

Part Description	Part Number	Package	Mark	Pcs/Reel
1.2V No Discharge DFN1x1-4	ETA5070V120NF1E	DFN1x1-4	A2 <u>YW</u>	10000
1.2V with Discharge DFN1x1-4	ETA5070V120DF1E	DFN1x1-4	A1 <u>YW</u>	10000
1.8V No Discharge DFN1x1-4	ETA5070V180NF1E	DFN1x1-4	A4 <u>YW</u>	10000
1.8V with Discharge DFN1x1-4	ETA5070V180DF1E	DFN1x1-4	A3 <u>YW</u>	10000
2.5V No Discharge DFN1x1-4	ETA5070V250NF1E	DFN1x1-4	B4 <u>YW</u>	10000
2.5V with Discharge DFN1x1-4	ETA5070V250DF1E	DFN1x1-4	B3 <u>YW</u>	10000
2.8V No Discharge DFN1x1-4	ETA5070V280NF1E	DFN1x1-4	B2 <u>YW</u>	10000
2.8V with Discharge DFN1x1-4	ETA5070V280DF1E	DFN1x1-4	B1 <u>YW</u>	10000
3.0V No Discharge DFN1x1-4	ETA5070V300NF1E	DFN1x1-4	C2 <u>YW</u>	10000
3.0V with Discharge DFN1x1-4	ETA5070V300DF1E	DFN1x1-4	C1 <u>YW</u>	10000
3.3V No Discharge DFN1x1-4	ETA5070V330NF1E	DFN1x1-4	C4 <u>YW</u>	10000
3.3V with Discharge DFN1x1-4	ETA5070V330DF1E	DFN1x1-4	C3 <u>YW</u>	10000
3.6V No Discharge DFN1x1-4	ETA5070V360NF1E	DFN1x1-4	C6 <u>YW</u>	10000
3.6V with Discharge DFN1x1-4	ETA5070V360DF1E	DFN1x1-4	C5 <u>YW</u>	10000
1.2V No Discharge SOT23-5	ETA5070V120NS2F	SOT23-5	A2 <u>YW</u>	3000
1.2V with Discharge SOT23-5	ETA5070V120DS2F	SOT23-5	A1 <u>YW</u>	3000
1.8V No Discharge SOT23-5	ETA5070V180NS2F	SOT23-5	A4 <u>YW</u>	3000
1.8V with Discharge SOT23-5	ETA5070V180DS2F	SOT23-5	A3 <u>YW</u>	3000
2.5V No Discharge SOT23-5	ETA5070V250NS2F	SOT23-5	B4 <u>YW</u>	3000
2.5V with Discharge SOT23-5	ETA5070V250DS2F	SOT23-5	B3 <u>YW</u>	3000
2.8V No Discharge SOT23-5	ETA5070V280NS2F	SOT23-5	B2 <u>YW</u>	3000
2.8V with Discharge SOT23-5	ETA5070V280DS2F	SOT23-5	B1 <u>YW</u>	3000
3.0V No Discharge SOT23-5	ETA5070V300NS2F	SOT23-5	C2 <u>YW</u>	3000

ETA5070



3.0V with Discharge SOT23-5	ETA5070V300DS2F	SOT23-5	C1YW	3000
3.3V No Discharge SOT23-5	ETA5070V330NS2F	SOT23-5	C4YW	3000
3.3V with Discharge SOT23-5	ETA5070V330DS2F	SOT23-5	C3YW	3000
3.6V No Discharge SOT23-5	ETA5070V360NS2F	SOT23-5	C6YW	3000
3.6V with Discharge SOT23-5	ETA5070V360DS2F	SOT23-5	C5YW	3000

