

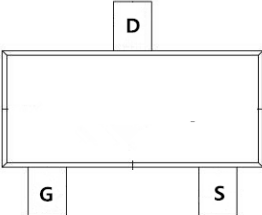

TM06N03MI

N-Channel Enhancement Mosfet

<p>General Description</p> <ul style="list-style-type: none"> • Low $R_{DS(ON)}$ • RoHS and Halogen-Free Compliant <p>Applications</p> <ul style="list-style-type: none"> • Load switch • PWM 	<p>General Features</p> <p>$V_{DS} = 30V$ $I_D = 6.0A$ $R_{DS(ON)} = 24m\Omega (typ.) @ V_{GS} = 10V$</p> <p>100% UIS Tested 100% R_g Tested</p> 
--	---



Marking: XO

MI:SOT-23-3L

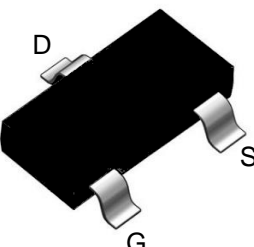

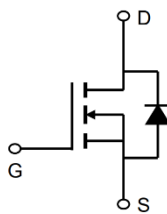

Absolute Maximum Ratings ($T_C = 25^\circ C$ unless otherwise noted)

Symbol	Parameter	Rating	Units
V_{DS}	Drain-Source Voltage	30	V
V_{GS}	Gate-Source Voltage	± 12	V
$I_D @ T_A = 25^\circ C$	Continuous Drain Current	6.0	A
$I_D @ T_A = 70^\circ C$	Continuous Drain Current	4.9	A
I_{DM}	Pulsed Drain Current ²	20	A
$P_D @ T_A = 25^\circ C$	Total Power Dissipation ³	1	W
T_{STG}	Storage Temperature Range	-55 to 150	$^\circ C$
T_J	Operating Junction Temperature Range	-55 to 150	$^\circ C$
$R_{\theta JA}$	Thermal Resistance Junction-ambient ¹	125	$^\circ C/W$
$R_{\theta JA}$	Thermal Resistance Junction-Ambient ¹ ($t \leq 10s$)	85	$^\circ C/W$

TM06N03MI
N-Channel Enhancement Mosfet
Electrical Characteristics ($T_J=25^\circ\text{C}$, unless otherwise noted)

Symbol	Parameter	Conditions	Min.	Typ.	Max.	Unit
BV_{DSS}	Drain-Source Breakdown Voltage	$V_{GS}=0V, I_D=250\mu A$	30	---	---	V
$\Delta BV_{DSS}/\Delta T_J$	BVDSS Temperature Coefficient	Reference to 25°C , $I_D=1\text{mA}$	---	0.029	---	V/ $^\circ\text{C}$
$R_{DS(on)}$	Static Drain-Source On-Resistance ²	$V_{GS}=10V, I_D=5A$	---	24	26	m Ω
		$V_{GS}=4.5V, I_D=3A$	---	27	29	
		$V_{GS}=2.5V, I_D=1A$	---	30	49	
$V_{GS(th)}$	Gate Threshold Voltage	$V_{GS}=V_{DS}, I_D=250\mu A$	0.5	0.9	1.2	V
$\Delta V_{GS(th)}$	$V_{GS(th)}$ Temperature Coefficient		---	-2.82	---	mV/ $^\circ\text{C}$
I_{DSS}	Drain-Source Leakage Current	$V_{DS}=24V, V_{GS}=0V, T_J=25^\circ\text{C}$	---	---	1	uA
		$V_{DS}=24V, V_{GS}=0V, T_J=55^\circ\text{C}$	---	---	5	
I_{GSS}	Gate-Source Leakage Current	$V_{GS}=\pm 12V, V_{DS}=0V$	---	---	± 100	nA
g_{fs}	Forward Transconductance	$V_{DS}=5V, I_D=5A$	---	25	---	S
R_g	Gate Resistance	$V_{DS}=0V, V_{GS}=0V, f=1\text{MHz}$	---	1.5	---	Ω
Q_g	Total Gate Charge (4.5V)	$V_{DS}=15V, V_{GS}=4.5V, I_D=5.8A$	---	11.5	---	nC
Q_{gs}	Gate-Source Charge		---	1.6	---	
Q_{gd}	Gate-Drain Charge		---	2.9	---	
$T_{d(on)}$	Turn-On Delay Time	$V_{DD}=15V, V_{GS}=10V, R_G=3\Omega$ $I_D=5A$	---	5	---	ns
T_r	Rise Time		---	47.	---	
$T_{d(off)}$	Turn-Off Delay Time		---	26	---	
T_f	Fall Time		---	8	---	
C_{iss}	Input Capacitance	$V_{DS}=15V, V_{GS}=0V, f=1\text{MHz}$	---	530	---	pF
C_{oss}	Output Capacitance		---	130	---	
C_{rss}	Reverse Transfer Capacitance		---	36	---	
I_S	Continuous Source Current ^{1,4}	$V_G=V_D=0V$, Force Current	---	---	6.0	A
V_{SD}	Diode Forward Voltage ²	$V_{GS}=0V, I_S=1A, T_J=25^\circ\text{C}$	---	---	1.2	V

Note :

- 1、The data tested by surface mounted on a 1 inch² FR-4 board with 2OZ copper.
- 2、The data tested by pulsed , pulse width $\leq 300\mu s$, duty cycle $\leq 2\%$
- 3、The power dissipation is limited by 150°C junction temperature
- 4、The data is theoretically the same as I_D and I_{DM} , in real applications , should be limited by total power dissipation.



TM06N03MI

N-Channel Enhancement Mosfet

Typical Characteristics

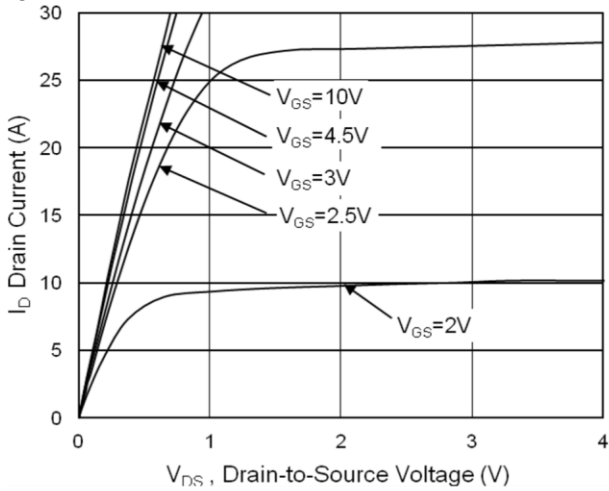

Fig.1 Typical Output Characteristics

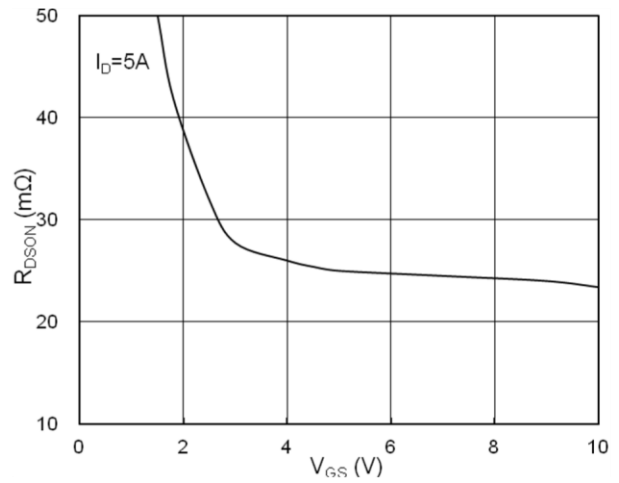

Fig.2 On-Resistance vs. Gate-Source

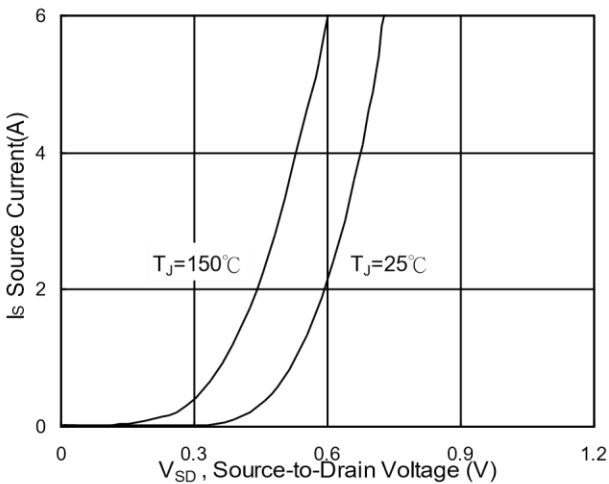

Fig.3 Forward Characteristics Of Reverse

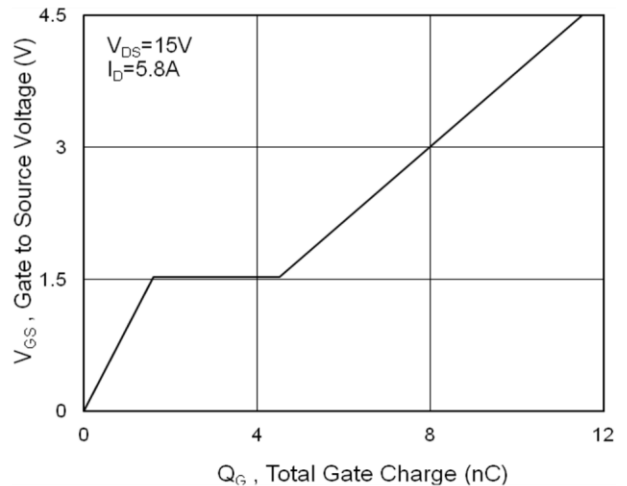

Fig.4 Gate-Charge Characteristics

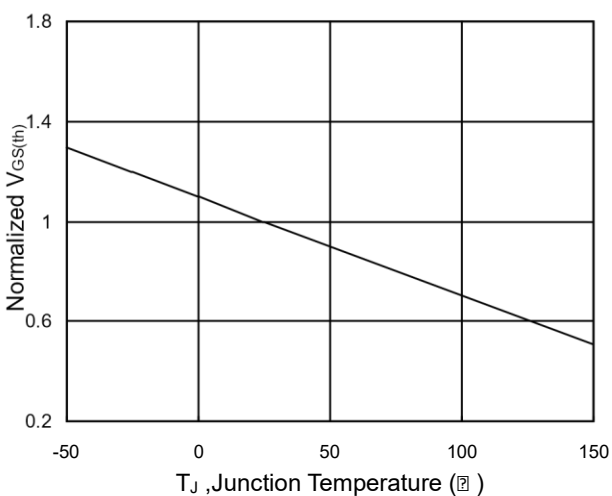

Fig.5 Normalized $V_{GS(th)}$ vs. T_J

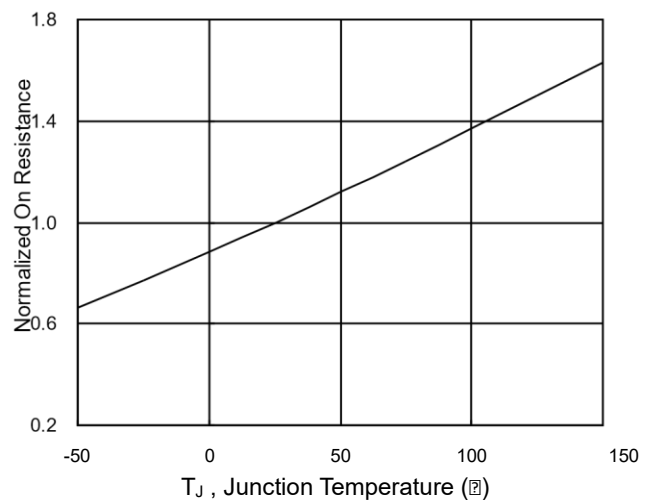

Fig.6 Normalized R_{DSON} vs. T_J

TM06N03MI

N-Channel Enhancement Mosfet

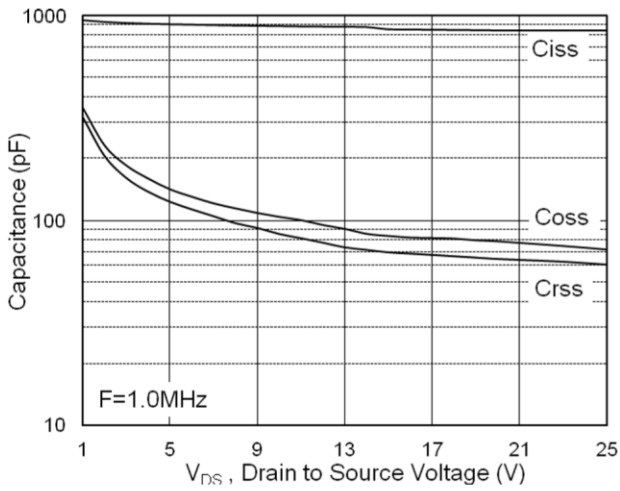

Fig.7 Capacitance

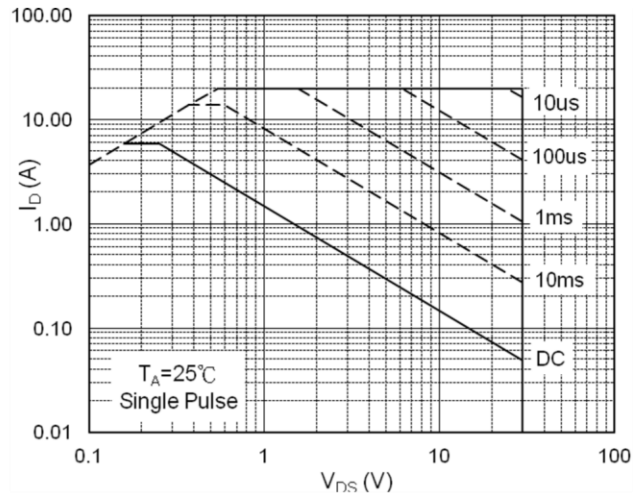

Fig.8 Safe Operating Area

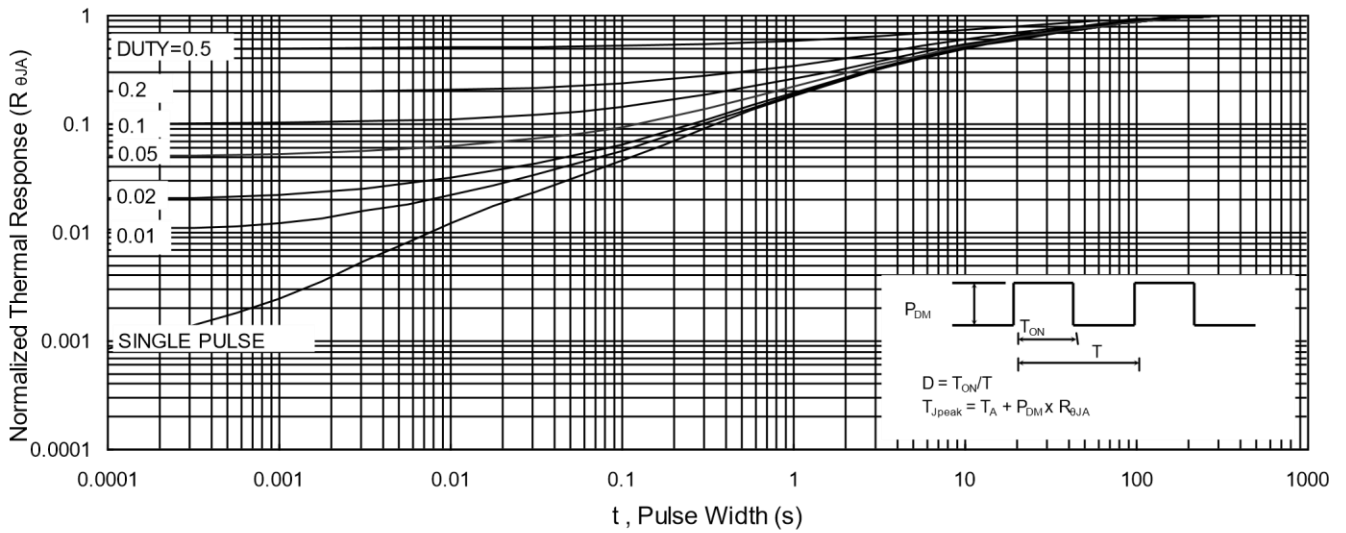

Fig.9 Normalized Maximum Transient Thermal Impedance

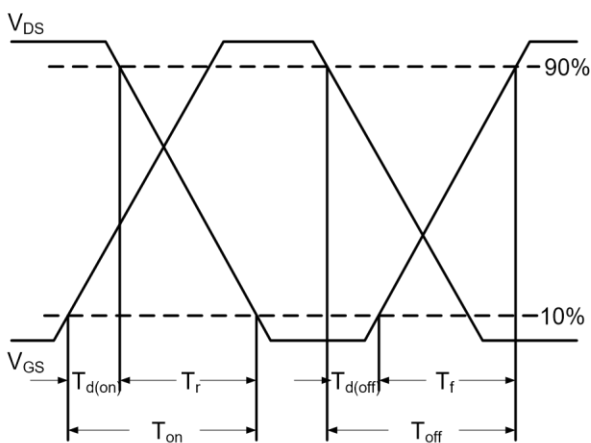

Fig.10 Switching Time Waveform

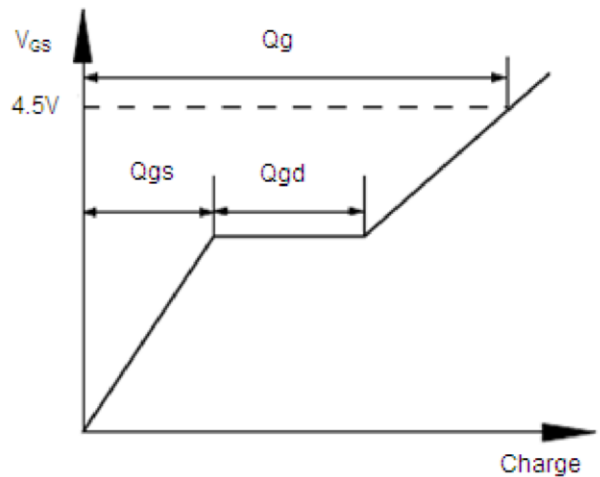
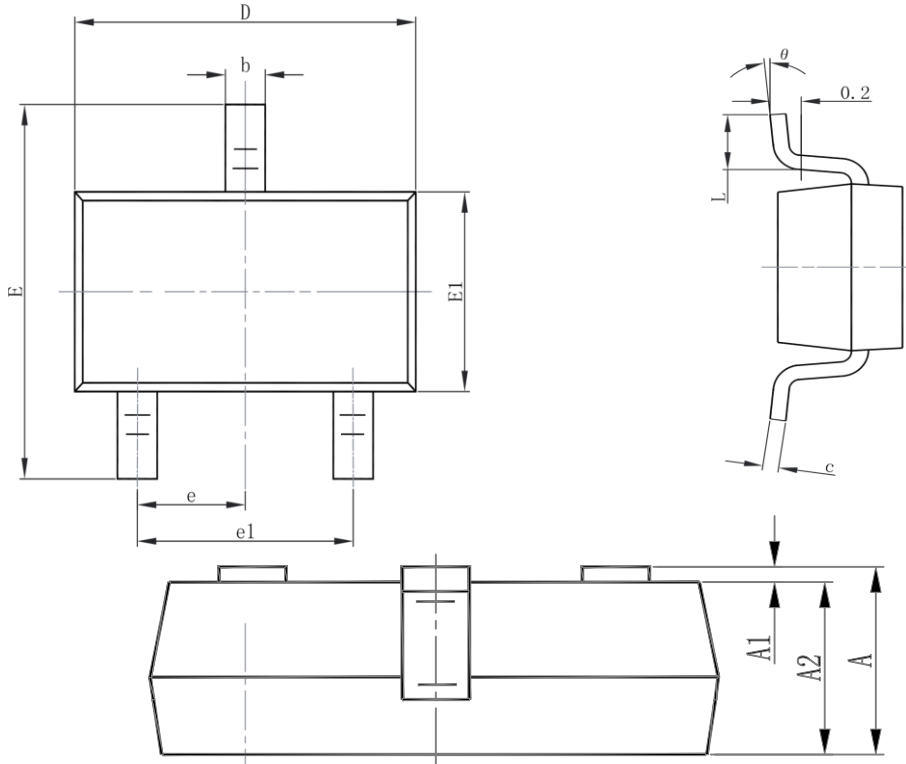

Fig.11 Gate Charge Waveform

Package Mechanical Data: SOT-23-3L



Symbol	Dimensions In Millimeters		Dimensions In Inches	
	Min.	Max.	Min.	Max.
A	1.050	1.250	0.041	0.049
A1	0.000	0.100	0.000	0.004
A2	1.050	1.150	0.041	0.045
b	0.300	0.500	0.012	0.020
c	0.100	0.200	0.004	0.008
D	2.820	3.020	0.111	0.119
E1	1.500	1.700	0.059	0.067
E	2.650	2.950	0.104	0.116
e	0.950(BSC)		0.037(BSC)	
e1	1.800	2.000	0.071	0.079
L	0.300	0.600	0.012	0.024
theta	0°	8°	0°	8°