

标记 MARK.	更改内容 MODIFICATION	日期 DATE	修改 DRAW	核准 APPROVE

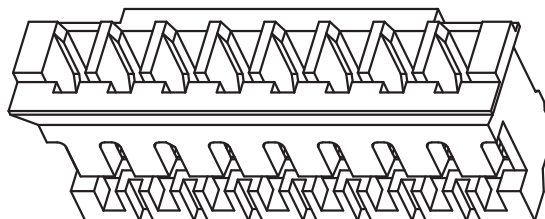
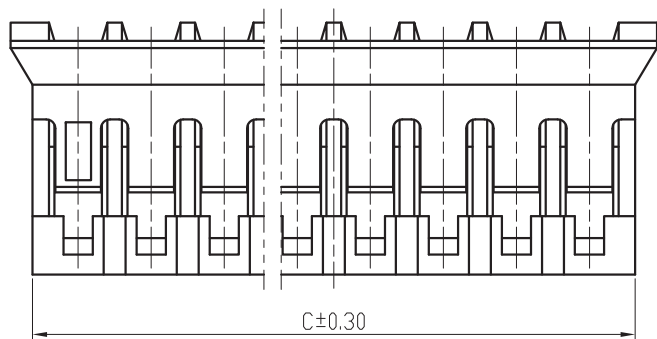
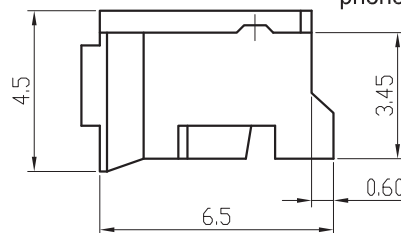
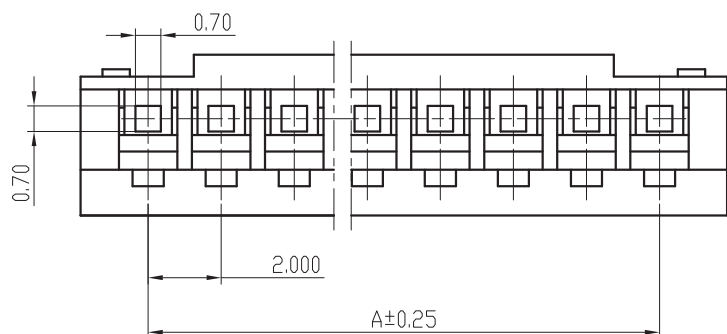
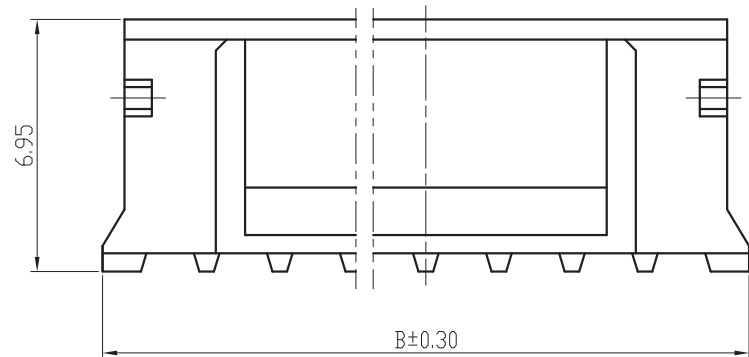

技术要求Specification:

- 1、材质Material: PA66 UL94V-0;
- 2、额定电流 Current rating:2.0A AC,DC
- 3、额定电压 Voltage rating: 100V AC,DC
- 4、温度范围 Temperature range:-25℃to+85℃
- 5、接触电阻 Contact resistance:≤20mΩ
- 6、绝缘电阻 Insulation resistance:≥1000MΩ
- 7、耐压 Withstand voltage:800V AC/minute
- 8、塑件表面平整光洁, 无明显的毛刺、气泡、变形、浇口拉伤、缺料等不良现象。

Plastic surface smooth and clean, no obvious burrs, bubbles, distortion, gate strain, lack of material and other undesirable phenomena.

线数	型号	尺寸		
		A	B	C
2	SH20001-2Y	2.00	5.70	4.50
3	SH20001-3Y	4.00	7.70	6.50
4	SH20001-4Y	6.00	9.70	8.50
5	SH20001-5Y	8.00	11.70	10.50
6	SH20001-6Y	10.00	13.70	12.50
7	SH20001-7Y	12.00	15.70	14.50
8	SH20001-8Y	14.00	17.70	16.50
9	SH20001-9Y	16.00	19.70	18.50
10	SH20001-10Y	18.00	21.70	20.50
11	SH20001-11Y	20.00	23.70	22.50
12	SH20001-12Y	22.00	25.70	24.50
13	SH20001-13Y	24.00	27.70	26.50
14	SH20001-14Y	26.00	29.70	28.50
15	SH20001-15Y	28.00	31.70	30.50
16	SH20001-16Y	30.00	33.70	32.50

TOLERANCE UNLESS OTHERWISE SPECIFIED		*: Inspection Item			
.X±0.30	X.° ±1°	(NO.)	:Cp/Cpk and SPC Control Item		
.XX±0.2	.X° ±	材料	PA66	名称	PH2.0胶壳-5Pin
.XXX±0.10	.XX° ±	料厚		编号	ZX-PH2.0-5PJk
制图		料宽		单位	m m
审核		日期		比例	1:1
批准		角法		版本	A1
APPROVE		PROJ.		规格书	