

Features

- Optimized glass passivated chip
- $T_J = 175\text{ }^\circ\text{C}$ capability suitable for high reliability and automotive requirement
- 6600W peak pulse power capability with a 10/1000 μs waveform, repetitive rate (duty cycle):0.01%
- Meets ISO16750-2 surge specification(varied by test condition)
- AEC-Q101 qualified
- Low leakage current
- Low forward voltage drop
- Uni-directional polarity
- Excellent clamping capability
- Very fast response time

Range: SM8S10A Thru. SM8S43A

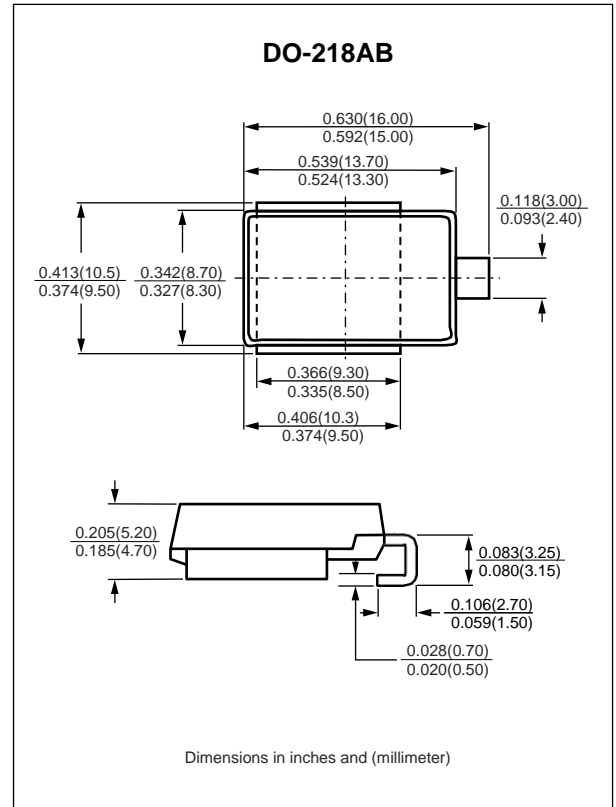

Mechanical Data

- Case: DO-218AB
- Polarity: Heatsink is anode
- RoHS Compliant



Maximum Ratings ($T_A=25\text{ }^\circ\text{C}$ unless otherwise noted)

Parameter	Symbol	Value	Unit
Peak power dissipation with a 10/1000 μs waveform ⁽¹⁾	P_{PP}	6600	W
Peak power dissipation with a 10/10,000 μs waveform	P_{PP}	5200	W
Peak pulse current with a 10/1000 μs waveform ⁽¹⁾	I_{PP}	See Next Table	A
Power dissipation on infinite heatsink at $T_L = 25\text{ }^\circ\text{C}$	P_D	8.0	W
Peak forward surge current 8.3 ms single half sine-wave	I_{FSM}	700	A
Operating junction and storage temperature range	T_J, T_{STG}	- 55 to +175	$^\circ\text{C}$

Note:

(1)Non-repetitive current pulse per Fig.2 and derated above $T_A= 25\text{ }^\circ\text{C}$ per Fig.1

Electrical Characteristics (T_A = 25°C unless otherwise noted)

Part Number (Uni)	Breakdown Voltage V _{BR} @I _T			Maximum Reverse Leakage I _R @V _{RWM} (uA)	Maximum I _R @V _{RWM} T _J =175°C (uA)	Working Peak Reverse Voltage V _{RWM} (V)	Maximum Reverse Surge Current I _{PP} (A)	Maximum Clamping Voltage V _C @I _{PP} (V)
	Min (V)	Max (V)	I _T (mA)					
SM8S10A	11.1	12.3	5.0	5.0	250	10	388	17.0
SM8S11A	12.2	13.5	5.0	5.0	150	11	363	18.2
SM8S12A	13.3	14.7	5.0	5.0	150	12	332	19.9
SM8S13A	14.4	15.9	5.0	5.0	150	13	307	21.5
SM8S14A	15.6	17.2	5.0	5.0	150	14	284	23.2
SM8S15A	16.7	18.5	5.0	5.0	150	15	270	24.4
SM8S16A	17.8	19.7	5.0	5.0	150	16	253	26.0
SM8S17A	18.9	20.9	5.0	5.0	150	17	239	27.6
SM8S18A	20.0	22.1	5.0	5.0	150	18	226	29.2
SM8S20A	22.2	24.5	5.0	5.0	150	20	204	32.4
SM8S22A	24.4	26.9	5.0	5.0	150	22	186	35.5
SM8S24A	26.7	29.5	5.0	5.0	150	24	170	38.9
SM8S26A	28.9	31.9	5.0	5.0	150	26	157	42.1
SM8S28A	31.1	34.4	5.0	5.0	150	28	145	45.4
SM8S30A	33.3	36.8	5.0	5.0	150	30	136	48.4
SM8S32A	35.5	39.4	5.0	5.0	150	32	128.5	51.4
SM8S33A	36.7	40.6	5.0	5.0	150	33	124	53.3
SM8S36A	40.0	44.2	5.0	5.0	150	36	114	58.1
SM8S40A	44.4	49.1	5.0	5.0	150	40	102	64.5
SM8S43A	47.8	52.8	5.0	5.0	150	43	95.1	69.4

NOTE:

1. Surge current waveform is defined at 10/1000uS waveform
2. For all types maximum V_F=1.8V at I_F=100A measured on 8.3ms single half sine-wave or equivalent square wave, duty cycle=4 pulses per minute maximum.

Ratings and Characteristics Curves ($T_A=25^\circ\text{C}$ unless otherwise Specified)

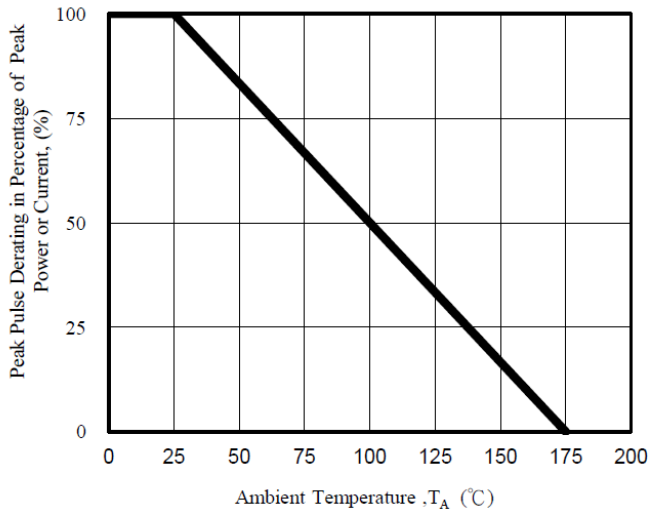

Fig. 1 - Pulse Derating Curve

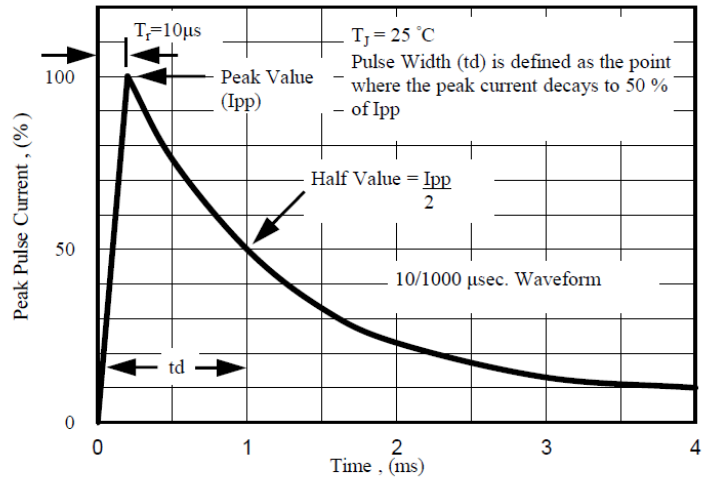

Fig. 2 - Pulse Waveform

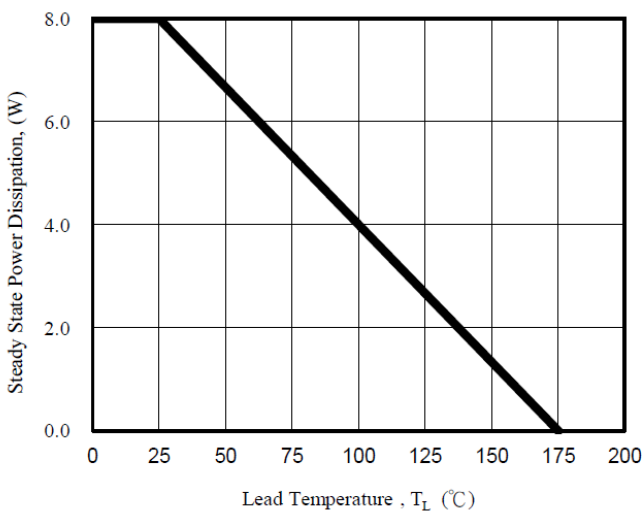

Fig. 3 - Steady State Power Derating Curve

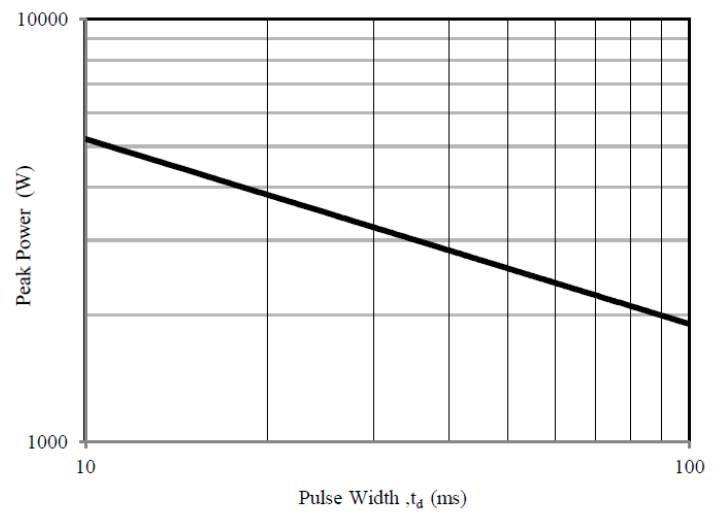
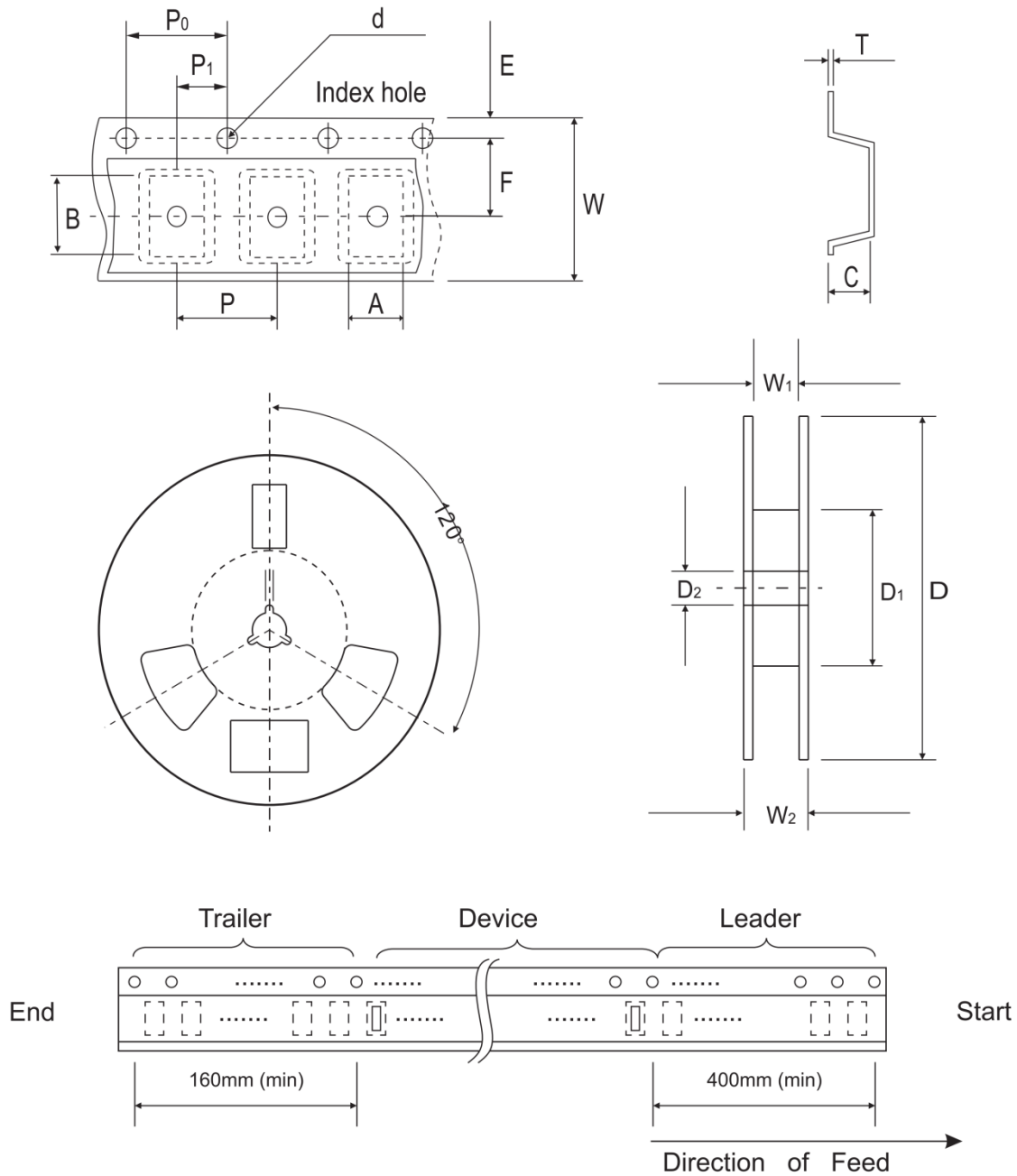

Fig. 4 - Peak Pulse Power Rating Curve

Reel Taping Specification



DO-218AB	SYMBOL	A	B	C	d	D	D1	D2
	(mm)	10.77 ± 0.10	16.33 ± 0.10	6.02 ± 0.10	1.50 + 0.10	330 ± 2.00	50.0 (MIN.)	20.2 (MIN.)
	(inch)	0.424 ± 0.004	0.643 ± 0.004	0.237 ± 0.004	0.059 + 0.004	13.00 ± 0.079	1.97 (MIN.)	0.795 (MIN.)
	SYMBOL	E	F	P	P0	P1	W	W1
	(mm)	1.75 ± 0.10	11.50 ± 0.10	16.00 ± 0.10	4.00 ± 0.10	2.00 ± 0.10	24.00+0.30/-0.10	30.4 (MAX.)
	(inch)	0.069 ± 0.004	0.453 ± 0.004	0.630 ± 0.004	0.157 ± 0.004	0.079 ± 0.004	0.945+0.012/-0.004	1.197 (MAX.)

Solder Reflow Recommendations

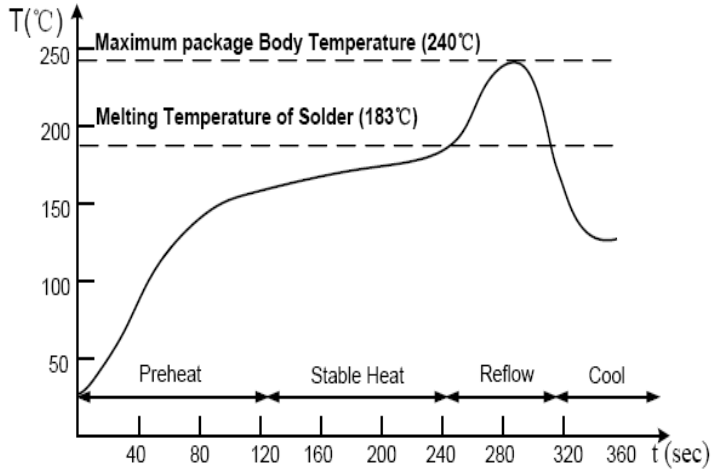

- Recommended reflow methods: IR, vapor phase oven, hot air oven, wave solder.
- The device can be exposed to a maximum temperature of 260°C for 8 seconds.
- Devices can be cleaned using standard industry methods and solvents.

Notes: If reflow temperatures exceed the recommended profile, devices may not meet the performance requirements.

Suggested PAD Layout

SIZE	DO-218AB	
	(mm)	(inch)
A	3.50	0.138
B	3.00	0.118
C	3.30	0.130
D	11.00	0.433
E	9.50	0.374
F	15.80	0.622

Marking Code

Part Number	
SM8S10A Thru. SM8S43A	
Polarity Indicator: Cathode Band (Note: Bi-directional devices have no polarity indicator.) Marking Code: Part Number (SM8S10A Thru. SM8S43A) XXXX: Date Code	

Ordering information

Part Number	Package	Base qty	Reel Size	Delivery mode
		(pcs)	(inch)	
SM8S10A Thru. SM8S43A	DO-218AB	750	13	Tape and reel