

RoHS 2.0

REV.	ECN NO.	DESCRIPTION	DATE	DESIGN
A1.	/.	新版发行	2022.12.02	LZR

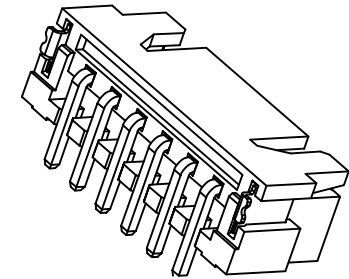

PIN	DIM A	DIM B	DIM C
2P	10.00	6.10	2.50
3P	12.50	8.60	5.00
4P	15.00	11.10	7.50
5P	17.50	13.60	10.00
6P	20.00	16.10	12.50

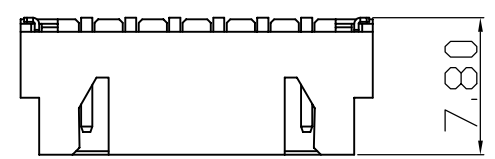
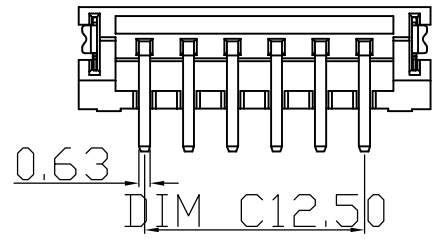
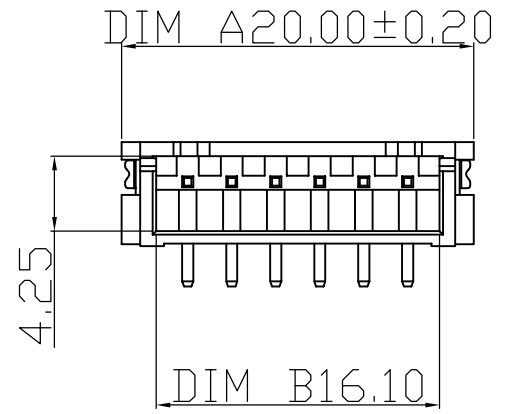
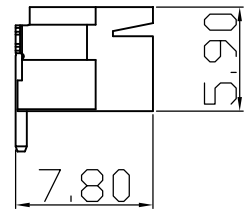

SPECIFICATION

- Contact resistance: $\leq 20\Omega$
- Insulation resistance: $\geq 1000\Omega$
- Rated voltage: 250 V AC DC
- Rated current: 3.0 A AC DC
- Withstand Voltage: 1000V AC/minute
- Temperature Range : $-25^{\circ}\text{C}\sim+85^{\circ}\text{C}$

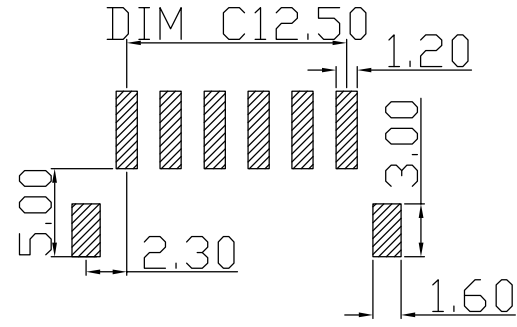
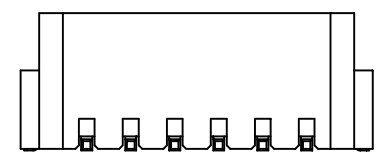

C	插片	黄铜H65	镀镍锡	
B	插针	黄铜H65	镀镍锡	
A	基座	LCP	本色	
序号	品名	材质	电镀/颜色	备注

深圳市虹成电子有限公司

RECOMMENDER P.C.B.LAYOUT TOP VIEW
(COMPONENT SIDE TOLERANCE±0.1)

UNLESS OTHERWISE, GENERAL TOLERANCE: X.xxx ±0.10 X.xx ±0.20 X.x ±0.30	NAME: 2.5针座立贴		P/N: HCZZ0514-11			
	THIRD ANGLE PROJECTION		DWG NO:			
ANGULAR: X.xx° ±1° X.x° ±3° X.° ±5°	DRAWN:	UNIT: MM	SCALE: 1:1	SIZE: A4	SHEET: 1/1	REV. A1
		CHECKED:		APPROVED:		