

REV.	EC#	DESCRIPTION	DATE	DRAWN	CHECK	APPROVED
1.00		初版发行	2018-04-22			

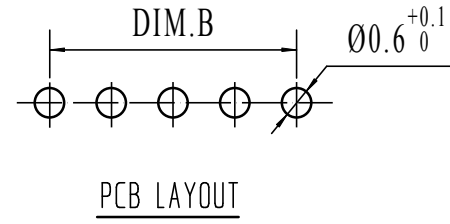
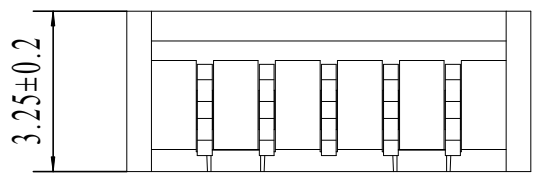
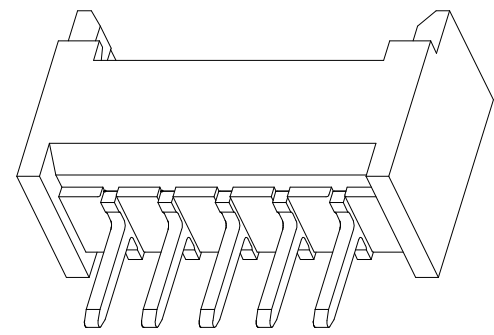
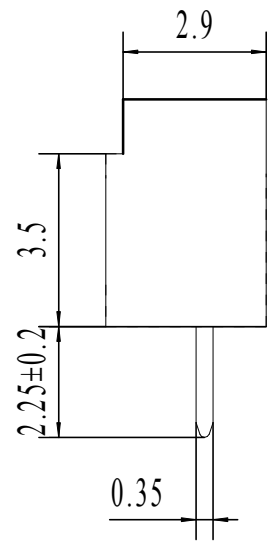
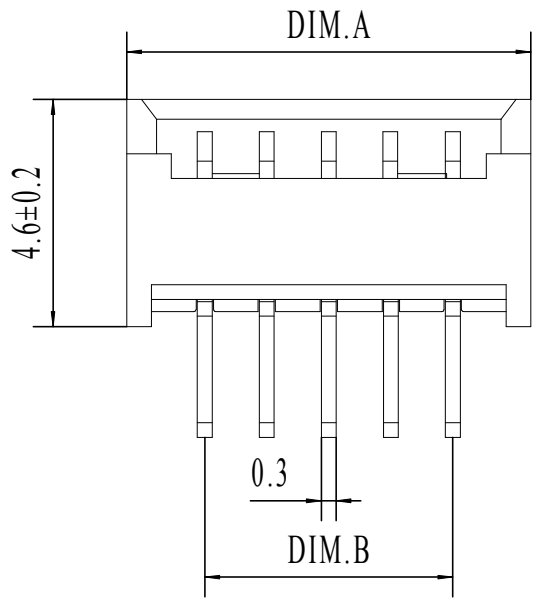

15	20.65	17.50
14	19.4	16.25
13	18.15	15.00
12	16.9	13.75
11	15.65	12.50
10	14.4	11.25
9	13.15	10.00
8	11.9	8.75
7	10.65	7.50
6	9.4	6.25
5	8.15	5.00
4	6.9	3.75
3	5.65	2.50
2	4.4	1.25
Pin	DIM.A	DIM.B

适应基板厚度: 1.2mm~1.6mm
 温度范围: -25°C~85°C
 额定电压: 125V AC/DC
 额定电流: 1A
 接触电阻: ≤0.02Ω
 绝缘电阻: ≥100MΩ
 耐压: 500V AC/minute

技术要求:

- 1) 材质: 见附表;
- 2) 电镀: 见附表;
- 3) 塑件表面平整、光洁、无毛刺、气泡、烧焦、变形、浇口无拉伤、多料或缺料等不良现象;
- 4) 端子表面无氧化、电镀不良等现象。

GENERAL TOLERANCES			
DIM	TOL	DIM	DEG
X		X°	±3.00°
X.X	±0.35	X.X°	±2.00°
X.XX	±0.25	X.XX°	±1.00°
X.XXX	±0.15	X.XXX°	

2	PIN	n PCS	材质: 黄铜, 电镀: 镀亮锡60u"MIN
1	Housing	1 PCS	材质: PA6T 颜色: 本色或黑色
NO.	NAME	QTY	DESCRIPTION

深圳市虹成电子有限公司

DRAW:	2018-04-22	TITLE:	1.25LDIP CONN WAFER	DRAW NAME:	HCZZ0566-8
DESIGN:	2018-04-22	SERIES:	12502 SERIES	DRAW NO.	
CHECK:	2018-04-22	P/N:		UNIT:	SHEET:
APPROVED	2018-04-22	CUSTOMER DRAWING	REV. 1.00	SCALE	N/A
		mm	1/1		