

SPECIFICATION FOR APPROVAL

Customer : _____

Customer P/N: _____

Drawing No : _____

Quantity : _____ **Pcs.** **Date :** **2020/06/17**

Chilisin P/N : **APPM00070638701XZ0**

Automotive Grade Inductor

Halogen Free
RoHS Compliant
REACH Compliant
Lead Free Solders
AEC-Q200

奇力新電子股份有限公司
 Chilisin Electronics Corp
 No. 29, Alley 301, Tehhsin Rd.,
 Hukou, Hsinchu 303, Taiwan
 TEL : +886-3- 599-2646
 FAX : +886-3- 599-9176
 E-mail : sales@chilisin.com
 http : //www.chilisin.com

東莞奇力新電子(東莞廠)有限公司
 Chilisin Electronics (Dongguan) Co., Ltd.
 No. 78, Puxing Rd., Yuliangwei Administration
 Area, Qingxi Town, Dongguan City,
 Guangdong, China
 TEL : +86-769-8773-0251~3
 FAX : +86-769-8773-0232
 E-mail : cect@chilisin.com

奇力新電子(越南廠)有限公司
 Chilisin Electronics (Vietnam) Limited
 No 143 - 145, Road No 10, VSIP Hai
 Phong, Lap Le Commune, Thuy Nguyen
 Dist, Haiphong City, Vietnam
 Tel : 84-316 255 688 Fax : 84-316 255
 689
 E-mail : sales@chilisin.com

奇力新電子(湖南廠)有限公司
 HuNan Chilisin Electronics Technology Co., Ltd
 No. 8, Shaziao Liangshuijing Town, Yuanling
 County, Huaihua City, Hunan Province 419601,
 China
 Tel : 86-745-867-5882
 E-mail : cect@chilisin.com

Applied by

Checked by

Approved by

APPM00070638 Series Specification

AEC-Q200

1 Scope: This specification applies to SMD Common mode filter

2 Part Numbering:

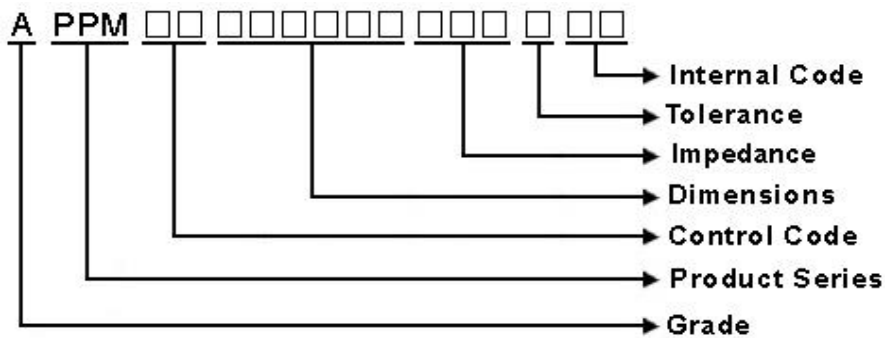

3 Rating:

Operating Temperature: - 5 0 °C ~ 1 5 0 °C(Including self - temperature rise)

Storage Temperature: - 5 0 °C ~ 1 5 0 °C

4 Marking:



Ex Marking : 701

Marking color : White

5 Standard Testing Condition

	Unless otherwise specified	In case of doubt
Temperature	Ordinary Temperature(15 to 35°C)	20 to 30°C
Humidity	Ordinary Humidity(25 to 85% RH)	50 to 80 %RH

APPM00070638 Series Specification

AEC-Q200

6 Configuration and Dimensions:

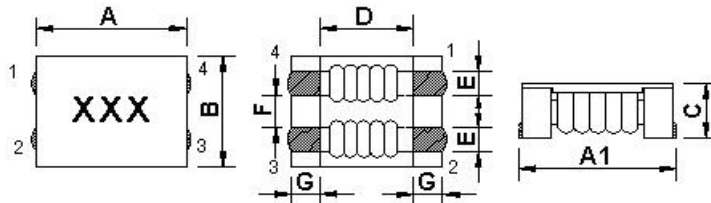

Dimensions in mm

TYPE	070638
A	7.0±0.5
A1	7.5±0.5
B	6.0±0.5
C	3.8Max.
D	3.5Typ.
E	1.5±0.3
F	1.5±0.3
G	1.75±0.2

7 Electrical Characteristics:

Part No.	Impedance (Ω)Min.	Impedance (Ω)Typ.	Test Freq.	RDC(mΩ)Max. (1 line)	Rated Current (A)Max.	Insulation Resistance (MΩ)Min.	Rated Voltage (V)Max.	Marking
APPM00070638101XZ0	100	140	100MHz,0.5V	10	9	10	125	101
APPM00070638301XZ0	225	300	100MHz,0.5V	10	5	10	125	301
APPM00070638701XZ0	500	700	100MHz,0.5V	15	4	10	125	701
APPM00070638102XZ0	800	1020	100MHz,0.5V	17	3	10	125	102
APPM00070638132XZ0	910	1300	100MHz,0.5V	21	2.5	10	125	132
APPM00070638272XZ0	2000	2700	100MHz,0.5V	63	1	10	125	272
APPM00070638302XZ0	2500	3000	100MHz,0.5V	75	0.9	10	125	302

NOTE:

1. Operating temperature range - 5 0 °C ~ 1 5 0 °C(Including self - temperature rise)
2. Rated Current:Based on temperature rise (ΔT:40°C TYP)

APPM00070638 Series Specification

AEC-Q200

8 APPM00070638 Series

8.1 Construction:

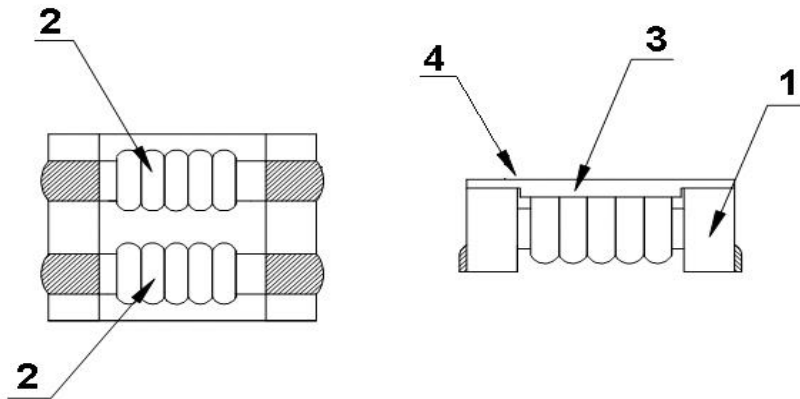

8.2 Material List:

No	Part
1	Ferrite core
2	Wire
3	LCP
4	INK

CHARACTERISTICS(REFERENCE)

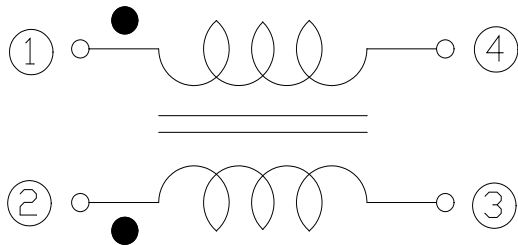

TEST EQUIPMENT

1. Impedance

Measured by HP4291B RF Impedance Analyzer.

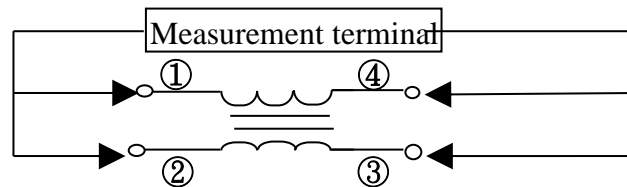

2. DC Resistance

Measured by Chroma 16502 milliohm meter.

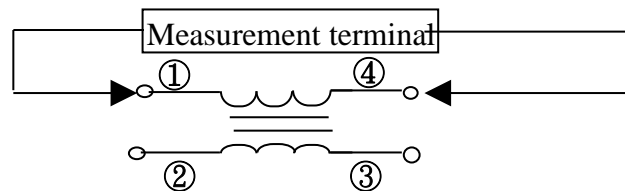

3. Insulation Resistance

Measured by Chroma 19073

Measurement voltage : 50V , Measurement time : 3 sec.

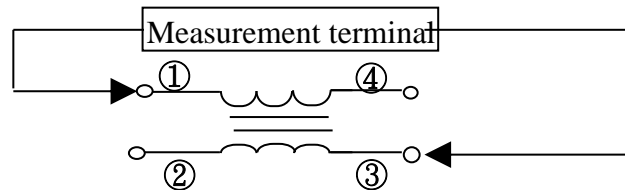

APPM00070638 Series Specification

AEC-Q200

9 Reliability Of SMD Common mode filter

MECHANICAL

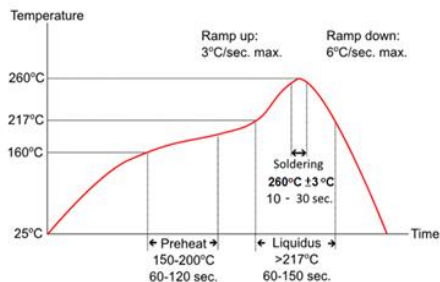
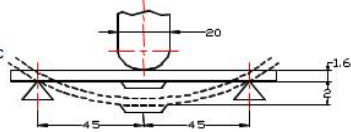
TEST ITEM	SPECIFICATION	TEST DETAILS
Solder ability	The electrodes shall be at least 90% covered with new solder coating	Refer to J-STD-002 Pre-heating: 150°C, 1min Solder Composition: Sn/Ag3.0/Cu0.5(Pb-Free) Solder Temperature: 245±5°C (Pb-Free) Immersion Time: 4±1sec
Resistance to Soldering heat (reflow soldering)	There shall be no damage or problems.	Refer to MIL-STD-202 Method 210 Temperature profile of reflow soldering  <p>The specimen shall be passed through the reflow oven with the condition shown in the above profile for 1 time. The specimen shall be stored at standard atmospheric conditions for 1 hour, after which the measurement shall be made.</p>
Terminal strength	The terminal electrode and the ferrite must not be damaged.	Refer to AEC-Q200-006 With the component mounted on a PCB obtained from the Supplier with the device to be tested, apply a 17.7 N (1.8 Kg) force to the side of a device being tested. This force shall be applied for 60 ±1 seconds.
Board Flex	The terminal electrode and the ferrite must not be damaged.	Refer to AEC-Q200-005 Test device shall be soldered on the substrate Substrate Dimension: 100x40x1.6mm Deflection: 2.0mm Keeping Time: 60sec 
High temperature resistance (Storage)	Impedance: Within ±20% of the initial value. Insulation resistance and DC resistance on the specification (refer to clause 2-1) shall be met. The terminal electrode and the ferrite must not be damaged.	Refer to MIL-STD-202 Method 108 Temperature: 150±3°C / Relative Humidity: 0% Time: 1000hrs Measured after exposure in the room condition for 24hrs
Biased Humidity	No apparent damage Fulfill the electrical spec. after test.	Refer to MIL-STD-202 Method 103 Temperature: 85±2°C Relative Humidity: 85% / Time: 1000hrs Measured after exposure in the room condition for 24hrs

APPM00070638 Series Specification

AEC-Q200

MECHANICAL

TEST ITEM	SPECIFICATION	TEST DETAILS
Thermal shock	<p>Impedance: Within $\pm 20\%$ of the initial value.</p> <p>Insulation resistance and DC resistance on the specification (refer to clause 2-1) shall be met.</p> <p>The terminal electrode and the ferrite must not be damaged.</p>	<p>Refer to JESD Method JA-104</p> <p>Total cycles: 1000 cycles</p> <p>Temperature Cycling Test Conditions : -50 to +150 °C</p> <p>-50 °C Soak Mode Condition : 30 minutes</p> <p>150 °C Soak Mode Condition : 30 minutes</p> <p>Measured after exposure in the room condition for 24hrs</p>
Low temperature storage	<p>Impedance: Within $\pm 20\%$ of the initial value.</p> <p>Insulation resistance and DC resistance on the specification (refer to clause 2-1) shall be met.</p> <p>The terminal electrode and the ferrite must not be damaged.</p>	<p>After the samples shall be soldered onto the test circuit board, the test shall be done.</p> <p>Measurement : After placing for 24 hours min.</p> <p>Temperature : $-50 \pm 2^\circ\text{C}$</p> <p>Testing time : 1000 hours</p>
Vibration	<p>Impedance: Within $\pm 20\%$ of the initial value.</p> <p>Insulation resistance and DC resistance on the specification (refer to clause 2-1) shall be met.</p> <p>The terminal electrode and the ferrite must not be damaged.</p>	<p>Refer MIL-STD-202 Method 204</p> <p>Vibration waveform: Sine waveform</p> <p>Vibration frequency: 10Hz~2000Hz</p> <p>Vibration acceleration: 5g</p> <p>Sweep rate: 0.764386 octave/minute</p> <p>Duration of test: 12 cycles each of 3 orientations, 20 minutes for each cycle</p> <p>Vibration axes: X, Y & Z</p>
Resistance to Solvent	<p>There must be no change in appearance or obliteration of marking</p>	<p>Refer to MIL-STD-202 Method 215</p> <p>Inductors must withstand 6 minutes of alcohol or water.</p>
Operational Life	<p>No apparent damage</p> <p>Impedance: Within $\pm 20\%$ of the initial value.</p>	<p>Refer to MIL-STD-202 Method 108</p> <p>Temperature: $150 \pm 3^\circ\text{C}$</p> <p>Applied Current : Rated Current</p> <p>Time: 1000hrs</p> <p>Measured after exposure in the room condition for 24hrs</p>

APPM00070638 Series Specification

AEC-Q200

10 Packaging:

10.1 Packaging -Cover Tape

The force for tearing off cover tape is 10 to 130 grams in the arrow direction.

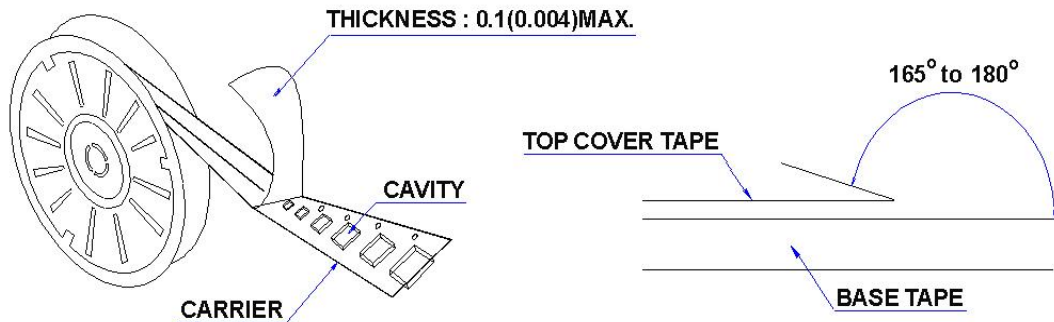

10.2 Packaging Quantity

TYPE	PCS/REEL
070638	1500

10.3 Reel Dimensions

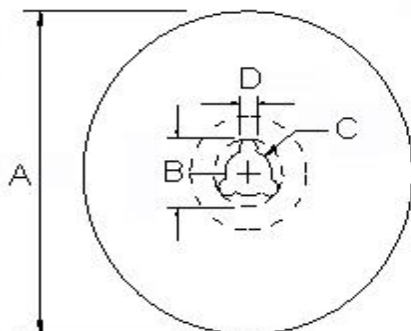

Dimensions in mm

TYPE	A	B	C	D
070638	330	20	13	2

APPM00070638 Series Specification

AEC-Q200

10 Packaging:

10.4 Tape Dimensions in mm

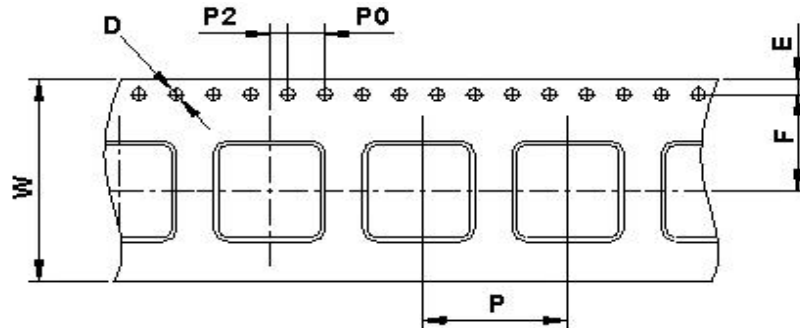

TYPE	W	D	E	F	P	P0	P2
070638	16	1.5	1.75	7.5	12	4	2

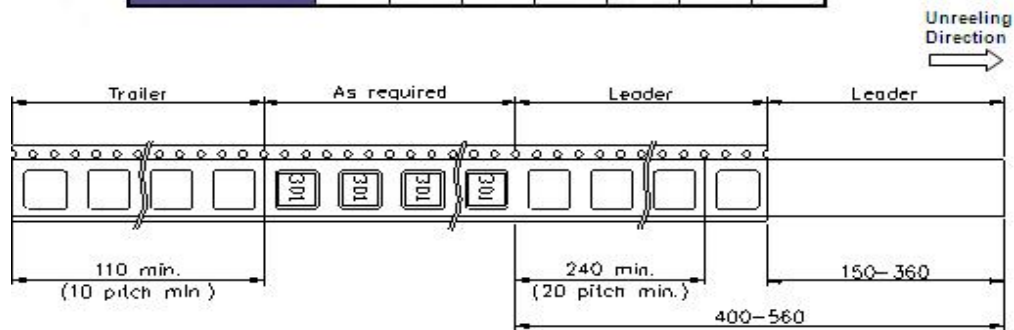

11 Recommended Land Pattern:

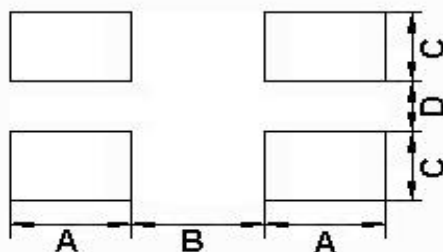

Dimensions in mm

TYPE	A	B	C	D
070638	2.9	3.2	1.9	1.3

12 Note:

- Please make sure that your product has been evaluated and confirmed against your specifications when our product is mounted to your product.
- Do not knock or drop.
- All the items and parameters in this product specification have been prescribed on the premise that our product is used for the purpose, under the condition and in the environment agreed upon between you and us. You are requested not to use our product deviating from such agreement.
- Please keep the distance between transformer/coil and other components (refer to the standard IEC 950)
- The moisture sensitivity level (MSL) of products is classified as level 1.

APPM00070638 Series Specification

AEC-Q200

13 Graph: APPM00070638701XZ0

