

»Features

- Fast Switching Speed
- For General Purpose Switching Applications
- High Conductance

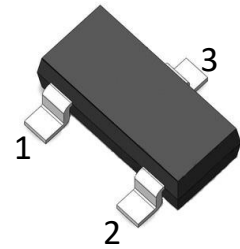

»General Description

- SOT-23 Small Outline Plastic Package
- Mounting Position: Any

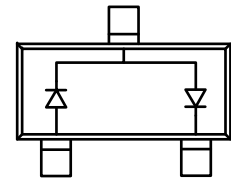

»Absolute Maximum Ratings @ $T_A=25^{\circ}\text{C}$ unless otherwise noted

Symbol	Parameter	Value	Unit
V_{RM}	Non-Repetitive Peak Reverse Voltage	100	V
V_{RRM}	Peak Repetitive Peak Reverse Voltage	75	V
V_{RWM}	Working Peak Reverse Voltage		
V_R	DC Blocking Voltage		
$V_{R(RMS)}$	RMS Reverse Voltage	53	V
I_o	Average Rectified Output Current	200	mA
I_{FSM}	Non-repetitive Peak Forward Surge Current@8.3mS	2.0	A
P_d	Power Dissipation	225	mW
$R_{\theta JA}$	Thermal Resistance From Junction To Ambient	556	$^{\circ}\text{C}/\text{W}$
T_J	Operation Junction Temperature Range	-55~+150	$^{\circ}\text{C}$
T_{STG}	Storage Temperature Range	-55~+150	$^{\circ}\text{C}$

»Electrical Characteristics @ $T_A=25^{\circ}\text{C}$ unless otherwise noted

Symbol	Parameter	Test conditions	Min	Max	Unit
$V_{(BR)}$	Reverse breakdown voltage	$I_R=100\mu\text{A}$	100		V
I_R	Reverse current	$V_R=50\text{V}$		1.0	μA
		$V_R=100\text{V}$		3.0	μA
V_{F1}	Forward voltage	$I_F=1\text{mA}$	0.55	0.70	V
V_{F2}		$I_F=10\text{mA}$	0.67	0.82	V
V_{F3}		$I_F=100\text{mA}$	0.75	1.1	V
C_T	Capacitance between terminals	$V_R=0\text{V}, f=1\text{MHz}$		2	pF
t_{rr}	Reverse recovery time	$I_F=I_R=10\text{mA}, I_{rr}=0.1 \times I_R, R_L=100\Omega$		4	nS

»Typical Performance Characteristics (($T_J = 25\text{ }^\circ\text{C}$, unless otherwise noted))

Forward Characteristics

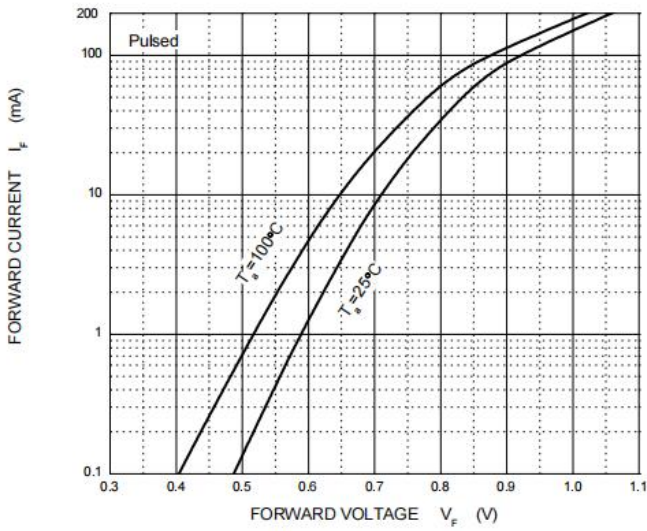

Reverse Characteristics

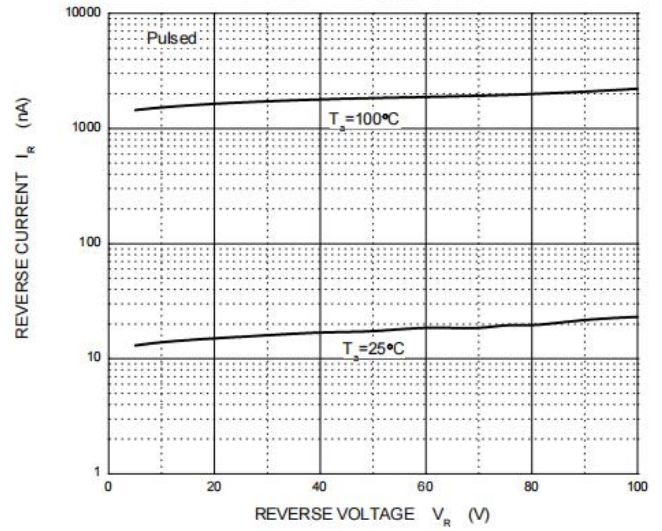

Capacitance Characteristics

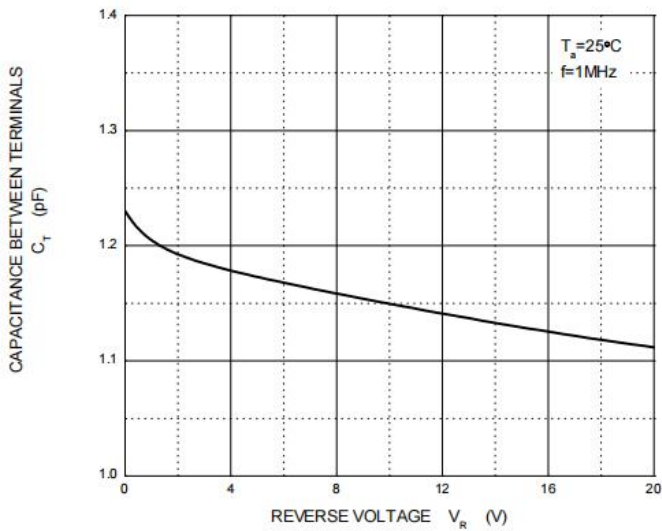

Power Derating Curve

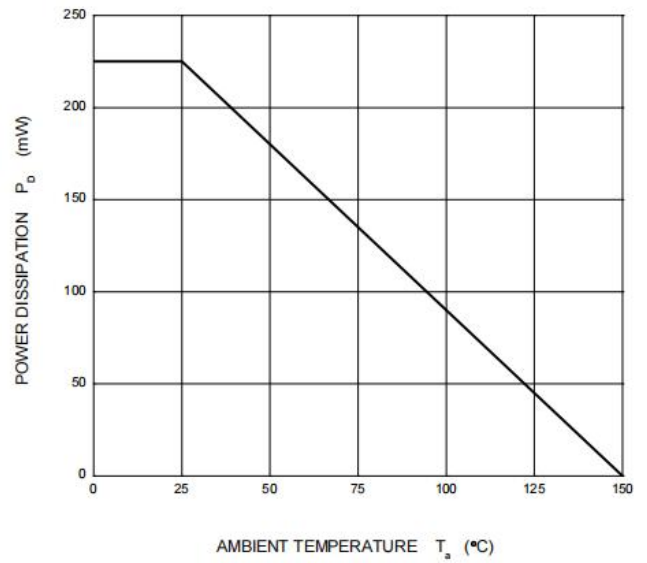

»Package Information-SOT23

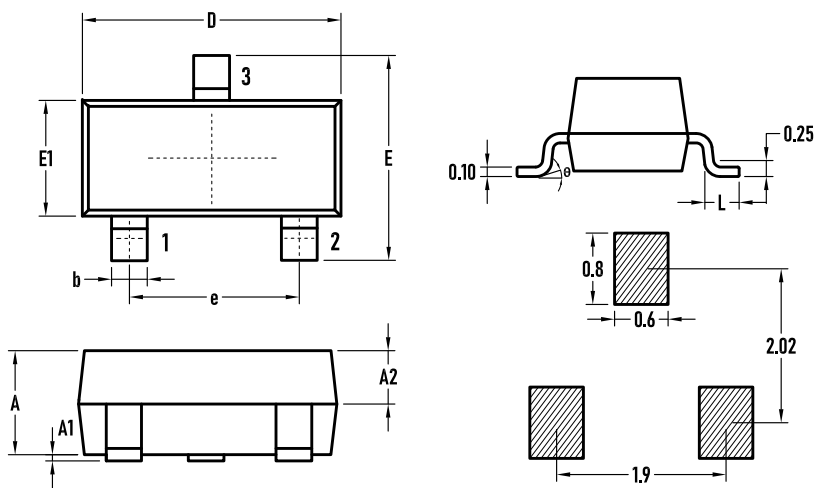

SYMBOL	MILLIMETER		
	MIN.	Typ.	MAX.
A	0.90	1.00	1.10
A1	0.02	0.06	0.10
A2	–	0.60	–
D	2.85	2.90	2.95
b	0.37	0.40	0.43
E	2.35	2.40	2.45
E1	1.25	1.30	1.35
e	1.85	1.90	1.95
L	0.35	0.40	0.48
θ	0	–	6°

»Marking

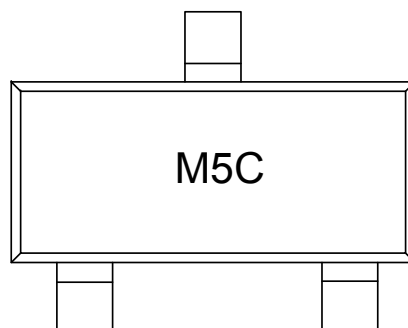

»Ordering information

Order code	Package	Base qty	Delivery mode
MMBD7000	SOT-23	3K	Tape and reel